

Koken

Llaves de Vaso

KOKEN IIIIII



PÁG.

82	1/4"
94	3/8"
114	1/2"
136	3/4"
142	1"

Llaves de Vaso

□ 1/4" □ 3/8" □ 1/2" □ 3/4" □ 1"

KOKEN IIIIII

Flat Drive®



El diseño de Contacto Plano garantiza una superficie de contacto plana entre el vaso y el perno/tuerca. El contacto plano reduce el desgaste y permite transmitir un par mayor.

El sistema de Contacto Plano se utiliza tanto para el extremo del cuadrado conductor como para la boca hexagonal o bihexagonal del vaso.

Surface Drive®



Los vasos de contacto curvo se diseñan para mantener el contacto con las caras planas de la tuerca y transmitir un alto par reduciendo el desgaste de la tuerca. Estos vasos son ideales para utilizarse en tuercas pulidas, tuercas de aluminio y tuercas con puntas desgastadas.

Nut Grip®



El perno/tuerca se sujeta firmemente por medio de dos bolas en la boca hexagonal para un trabajo seguro y fiable.

Vasos con punta



La más amplia gama de vasos con punta:

- ⊕ Punta Phillips
- ⊖ Punta Recta
- ⬢ Punta Hexagonal
- ⬠ Punta TORX®
- ⬠ Punta TORX® - Indeflexible
- ⬠ Punta TORX Plus®
- ⬠ Punta 5 lóbulos - Indeflexible
- ⬠ Punta XZN
- ⬠ Punta Ribe CV
- Macho cuadrado
- ⊕ Punta PZ

Llaves de carraca reversible



Sistema S.O.D.H.

Los dos trinquetes del cuerpo de la llave de carraca y sus muelles están dispuestos en el cuerpo de la llave de forma que se mantienen firmemente en posición permitiendo un cambio suave de la palanca de inversión y del trinquete.

El par sobre la rueda dentada se transmite verticalmente al trinquete, y al mismo tiempo al mango de la llave de carraca. Este mecanismo bloquea firmemente los dientes mientras se aplica el par, evitando así el desplazamiento de los mismos.



Trinquete de dos pasos

Los dientes de la rueda de la llave de carraca se inmovilizan por medio de los dientes aumentando de esta forma el par máximo de la llave en comparación con la llave de un paso.



Patentado

Trinquete de tres pasos



Trinquete de tres pasos

Se disponen dos trinquetes en el mismo eje y la rueda de la llave de carraca se bloquea por medio de tres dientes.

El aumento de la superficie de contacto produce un aumento de par de aproximadamente un 10% y el sistema S.O.D.H. Permite movimientos suaves y sin esfuerzo.



Dientes

24
GEARS

24
GEARS

30
GEARS

45
GEARS

24
GEARS



Llave de carraca con botón de extracción rápida

Los vasos y accesorios se bloquean en posición. Los vasos y alargaderas se extraen de la llave apretando el botón.



Cabeza Flexible



Caña de sección ovalada

Llaves de bujía con presilla



Esta nueva y revolucionaria llave de bujía se ha diseñado para sujetar la bujía firmemente por su parte hexagonal por medio de dos presillas de acero inoxidable.

Las presillas se mantienen en posición por medio de una guía interna de latón, asegurando una alineación perfecta de la bujía en el agujero roscado de la culata evitando el deterioro de la rosca.

La guía de latón elimina las tensiones excesivas y la posibilidad de deterioro del aislante cerámico de la bujía.

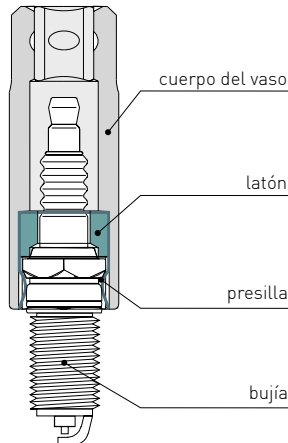

Caña de sección ovalada



El particular diseño de caña de sección ovalada proporciona más resistencia y durabilidad a la herramienta

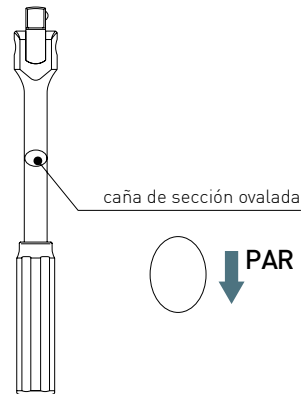

En los mangos corredizos la sección ovalada impide además el giro de la pieza cuadrada.

Alargaderas



Moleteadas

El moleteado externo en la zona superior de la alargadera facilita el agarre y permite la utilización como herramienta de giro rápido.



Articuladas-Fijas

Dos formas de utilización: Una, como alargadera flexible que permite trabajar con un ángulo de 15° y otra como alargadera fija.

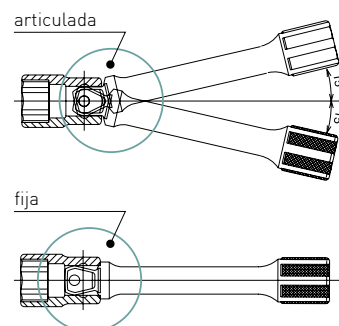

Articulaciones Universales



La articulación universal consta de tres piezas. Cada pieza está cromada por separado, de forma que se evita la corrosión producida por las gotas de agua que quedan después del cromado. Lo que ocurre si la articulación se cromó ya montada.

○ VASOS HEXAGONALES

mm	pulgadas	D1	D2	ℓ	L	⚖	Ref Métrica	€	Ref Pulgadas	€
3	1/8	5,5	11,2	2,6	22	7	2400M3	3,42	2400A1/8	3,61
3,5		6,1	11,2	3,0	22	7	2400M3,5	3,42		
4	5/32	6,7	11,2	3,5	22	8	2400M4	3,42	2400A5/32	3,61
4,5		7,3	11,2	4,0	22	8	2400M4,5	3,11		
5	3/16	8,0	11,2	5,0	22	8	2400M5	3,11	2400A3/16	3,30
5,5	7/32	8,5	11,2	5,5	22	9	2400M5,5	3,11	2400A7/32	3,30
6		9,2	11,2	5,5	22	9	2400M6	3,11		
	1/4	9,6	11,2	5,8	22	9			2400A1/4	3,30
7	9/32	10,3	11,2	6,0	22	9	2400M7	3,11	2400A9/32	3,30
8	5/16	11,2	11,7	6,9	22	11	2400M8	3,11	2400A5/16	3,30
9	11/32	13,0	12,0	7,3	22	12	2400M9	3,30	2400A11/32	3,42
10	3/8	14,3	12,9	7,7	22	15	2400M10	3,30	2400A3/8	3,42
11	7/16	15,5	14,3	9,3	22	18	2400M11	3,60	2400A7/16	3,74
12		16,8	15,5	9,3	22	23	2400M12	3,60		
13	1/2	18,0	16,4	9,8	22	23	2400M13	3,74	2400A1/2	3,91
14	9/16	19,3	17,9	11,0	24	30	2400M14	4,20	2400A9/16	4,21

» 2400M » 2400A

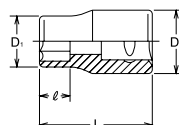

○ VASOS BIHEXAGONALES

mm	pulgadas	D1	D2	ℓ	L	⚖	Ref Métrica	€	Ref Pulgadas	€
3	1/8	5,5	11,2	2,6	22	7	2405M3	3,42	2405A1/8	3,61
3,5		6,1	11,2	3,0	22	7	2405M3,5	3,42		
4	5/32	6,7	11,2	3,5	22	8	2405M4	3,42	2405A 5/32	3,61
4,5		7,3	11,2	4,0	22	8	2405M4,5	3,11		
5	3/16	8,0	11,2	5,0	22	8	2405M5	3,11	2405A 3/16	3,3
5,5	7/32	8,5	11,2	5,5	22	9	2405M5,5	3,11	2405A 7/32	3,3
6		9,2	11,2	5,5	22	9	2450M6	3,11		
	1/4	9,6	11,2	5,8	22	9			2405A1/4	3,3
7	9/32	10,3	11,2	6,0	22	9	2405M7	3,11	2405A 9/32	3,3
8	5/16	11,2	11,7	6,9	22	11	2405M8	3,11	2405A 5/16	3,3
9	11/32	13,0	12,0	7,3	22	12	2405M9	3,30	2405A 11/32	3,42
10	3/8	14,3	12,9	7,7	22	15	2405M10	3,30	2405A3/8	3,42
11	7/16	15,5	14,3	9,3	22	18	2405M11	3,60	2405A7/16	3,74
12		16,8	15,5	9,3	22	23	2405M12	3,60		
13	1/2	18	16,4	9,8	22	23	2405M13	3,74	2405A1/2	3,91
14	9/16	19,3	17,9	11,0	24	30	2405M14	4,20	2405A9/16	4,21

» 2405M » 2405A

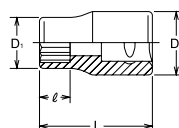

▤ ○ ○ JUEGO DE VASOS EN REGLETA

Ref	Tipo	▤	⚖	▤	▤	€
RS2400M/11	○ 2400M	200	222	11	4, 5, 6, 7, 8, 9, 10, 11, 12, 13, 14	30,50
RS2405M/11	○ 2405M	200	222	11	4, 5, 6, 7, 8, 9, 10, 11, 12, 13, 14	30,50

» RS2400M/11 » RS2405M/11



▤ ○ ○ JUEGO DE VASOS EN REGLETA

Ref	Tipo	▤	⚖	▤	▤	€
RS2400A/9	○ 2400A	150	152	9	3/16, 7/32, 1/4, 9/32, 5/16, 11/32, 3/8, 7/16, 1/2	26,21
RS2405A/9	○ 2405A	150	152	9	3/16, 7/32, 1/4, 9/32, 5/16, 11/32, 3/8, 7/16, 1/2	25,42

» RS2400A/9 » RS2405A/9



○ VASOS BIHEXAGONALES

pulgadas	D1	D2	ℓ	L	⚖	Ref	€
3/16	7,7	10,9	4,5	22	8	AS2405A3/16	3,96
7/32	8,5	10,9	4,9	22	8	AS2405A7/32	3,96
1/4	9,4	10,9	5,3	22	8	AS2405A1/4	3,87
9/32	10,2	10,9	5,5	22	8	AS2405A9/32	3,96
5/16	11,3	11,7	6,4	22	10	AS2405A5/16	3,96
11/32	12,5	12,0	6,8	22	10	AS2405A11/32	4,25
3/8	13,7	12,9	6,8	22	13	AS2405A3/8	4,25
7/16	15,6	14,3	8,8	22	17	AS2405A7/16	4,52
1/2	17,2	16,4	8,9	22	20	AS2405A1/2	5,29
9/16	18,8	17,9	9,1	24	27	AS2405A9/16	5,68

» AS2405A

[Norma Aeroespacial SAE AS954E]

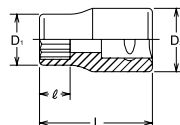

▤ ○ JUEGO DE VASOS EN REGLETA

Ref	Tipo	▤	⚖	▤	▤	€
RSAS2405A/10	○ AS2405A	150	160	10	3/16, 7/32, 1/4, 9/32, 5/16, 11/32, 3/8, 7/16, 1/2, 9/16	39,47

» RSAS2405A/10

[Norma Aeroespacial SAE AS954E]



○ VASOS SURFACE DRIVE (DE CONTACTO CURVO)

mm	D1	D2	ℓ	L	⚖	Ref	€
4	6,7	11,2	3,5	22	8	2410M4	3,61
4,5	7,3	11,2	4,0	22	8	2410M4,5	3,3
5	8,0	11,2	5,0	22	8	2410M5	3,3
5,5	8,5	11,2	5,5	22	9	2410M5,5	3,3
6	9,2	11,2	5,5	22	9	2410M6	3,3
7	10,3	11,2	6,0	22	9	2410M7	3,3
8	11,2	11,7	6,9	22	11	2410M8	3,3
9	13,0	12,0	7,3	22	12	2410M9	3,3
10	14,3	12,9	7,7	22	15	2410M10	3,3
11	15,5	14,3	9,3	22	18	2410M11	3,74
12	16,8	15,5	9,3	22	23	2410M12	3,74
13	18,0	16,4	9,8	22	23	2410M13	3,91
14	19,3	17,9	11,0	24	30	2410M14	4,21

» 2410M

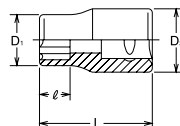

▤ ○ JUEGO DE VASOS EN REGLETA

Ref	Tipo	▤	⚖	▤	▤	€
RS2410M/11	○ 2410M	200	222	11	4, 5, 6, 7, 8, 9, 10, 11, 12, 13, 14	33,75

» RS2410M/11



○ VASOS OCTOGONALES

mm	pulgadas	D1	D2	ℓ	L	⚖	Ref Métrica	€	Ref Pulgadas	€
6		11,4	12,0	5,4	22	13	2415M6	3,20		
	1/4	11,7	12,0	5,4	22	14			2415A1/4	3,63
8	5/16	14,3	12,9	6,8	22	17	2415M8	4,16	2415A5/16	4,36
	3/8	17,4	16,0	8,2	22	26			2415A3/8	4,36
10		18,0	16,4	8,2	22	27	2415M10	4,16		

» 2415M » 2415A

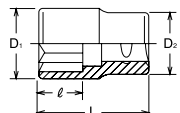

VASOS TORX®

TORX®	D1	D2	ℓ	L	⚖	Ref	€
E4	5,4	11,2	4,6	22	7	2425E-4	4,99
E5	6,7	11,2	5,2	22	8	2425E-5	4,99
E6	7,7	11,2	5,4	22	8	2425E-6	4,99
E7	8,3	11,2	6,6	22	9	2425E-7	4,99
E8	9,6	11,2	7	22	9	2425E-8	4,99
E10	11,3	12	8,2	22	10	2425E-10	4,99
E11	12,9	12	8,7	22	13	2425E-11	4,99
E12	14,3	12,9	9,3	23	17	2425E-12	4,99

» 2425

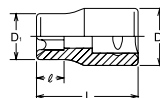

JUEGO DE VASOS EN REGLITA

Ref	Tipo	⚖	⚖	⚖	⚖	€
RS2425/6	○ 2425	150	90	6	E4, E5, E6, E7, E8, E10	23,92

» RS2425/6



VASOS HEXAGONALES LARGOS

mm	pulgadas	D1	D2	ℓ	L	⚖	Ref Métrica	€	Ref Pulgadas	€
3	1/8	5,5	11,2	3	50	15	2300M3	7,02	2300A1/8	7,34
4	5/32	6,7	11,2	4	50	15	2300M4	7,02	2300A5/32	6,71
4,5		7,3	11,2	4,5	50	15	2300M4,5	6,42		
5	3/16	8,0	11,2	5,5	50	17	2300M5	6,42	2300A3/16	6,71
5,5	7/32	8,5	11,2	6	50	17	2300M5,5	6,42	2300A7/32	6,71
6		9,2	11,2	7	50	20	2300M6	6,42		
	1/4	9,8	12,0	7	50	25			2300A1/4	6,71
7	9/32	10,5	11,2	8	50	25	2300M7	6,42	2300A9/32	6,71
8	5/16	11,8	11,2	9	50	25	2300M8	6,42	2300A5/16	6,71
9	11/32	13,0	12,0	10	50	30	2300M9	6,71	2300A11/32	6,71
10	3/8	14,3	12,9	11	50	34	2300M10	6,87	2300A3/8	7,18
11	7/16	15,5	14,3	12	50	43	2300M11	6,87	2300A7/16	7,18
12		16,8	15,5	13	50	50	2300M12	6,87		
13	1/2	18,0	16,4	14	50	52	2300M13	7,18	2300A1/2	7,64
14	9/16	19,3	17,9	16	50	57	2300M14	7,18	2300A9/16	7,64

» 2300M

» 2300A

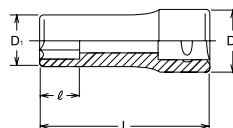
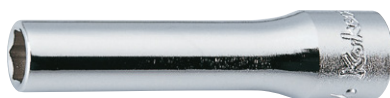

VASOS BIHEXAGONALES LARGOS

mm	pulgadas	D1	D2	ℓ	L	⚖	Ref Métrica	€	Ref Pulgadas	€
3	1/8	5,5	11,2	3	50	15	2305M3	7,02	2305A1/8	7,34
4	5/32	6,7	11,2	4	50	15	2305M4	7,02	2305A5/32	6,71
4,5		7,3	11,2	4,5	50	15	2305M4,5	7,02		
5	3/16	8,0	11,2	5,5	50	17	2305M5	6,42	2305A3/16	6,71
5,5	7/32	8,5	11,2	6	50	17	2305M5,5	6,42	2305A7/32	6,71
6		9,2	11,2	7	50	20	2305M6	6,42		
	1/4	9,8	12	7	50	25			2305A1/4	6,71
7	9/32	10,5	11,2	8	50	25	2305M7	6,42	2305A9/32	6,71
8	5/16	11,8	11,2	9	50	25	2305M8	6,42	2305A5/16	6,71
9	11/32	13,0	12,0	10	50	30	2305M9	6,42	2305A11/32	6,71
10	3/8	14,3	12,9	11	50	34	2305M10	6,87	2305A3/8	7,18
11	7/16	15,5	14,3	12	50	43	2305M11	6,87	2305A7/16	7,18
12		16,8	15,5	13	50	50	2305M12	6,87		
13	1/2	18,0	16,4	14	50	52	2305M13	7,18	2305A1/2	7,64
14	9/16	19,3	17,9	16	50	57	2305M14	7,18	2305A9/16	7,64

» 2305M » 2305A

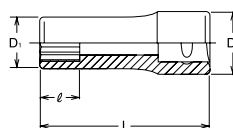

▄▄▄▄ ○ ○ JUEGO DE VASOS EN REGLETA

Ref	Tipo	▄▄▄▄	⚖	▣	▄▄▄▄	€
RS2300M/11	○ 2300M	200	437	11	4, 5, 6, 7, 8, 9, 10, 11, 12, 13, 14	66,01
RS2305M/11	○ 2305M	200	437	11	4, 5, 6, 7, 8, 9, 10, 11, 12, 13, 14	66,01

» RS2300M/11 » RS2305M/11



▄▄▄▄ ○ ○ JUEGO DE VASOS EN REGLETA

Ref	Tipo	▄▄▄▄	⚖	▣	▄▄▄▄	€
RS2300A/9	○ 2300A	150	269	9	3/16, 7/32, 1/4, 9/32, 5/16, 11/32, 3/8, 7/16, 1/2	55,53
RS2305A/9	○ 2305A	150	269	9	3/16, 7/32, 1/4, 9/32, 5/16, 11/32, 3/8, 7/16, 1/2	55,53

» RS2300A/9 » RS2305A/9



○ VASOS SURFACE DRIVE (DE CONTACTO CURVO) LARGOS

mm	D1	D2	ℓ	L	⚖	Ref	€
3	5,5	11,2	3	50	15	2310M3	6,52
4	6,7	11,2	4	50	15	2310M4	6,52
4,5	7,3	11,2	4,5	50	15	2310M4,5	6,52
5	8,0	11,2	5,5	50	17	2310M5	6,52
5,5	8,5	11,2	6	50	17	2310M5,5	6,52
6	9,2	11,2	7	50	20	2310M6	6,52
7	10,5	11,2	8	50	25	2310M7	6,52
8	11,8	11,2	9	50	25	2310M8	6,52
9	13,0	12,0	10	50	30	2310M9	6,52
10	14,3	12,9	11	50	34	2310M10	7,02
11	15,5	14,3	12	50	43	2310M11	7,02
12	16,8	15,5	13	50	50	2310M12	7,02
13	18,0	16,4	14	50	52	2310M13	7,48
14	19,3	17,9	16	50	57	2310M14	7,48

» 2310M

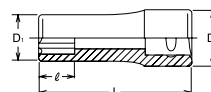

○ VASOS TORX® LARGOS

TORX®	D1	D2	ℓ	L	⚖	Ref Métrica	€
E4	5,4	12	4,6	50	17	2325E-4	11,64
E5	6,8	12	5,2	50	20	2325E-5	11,64
E6	8,0	12	5,4	50	20	2325E-6	11,64
E7	8,3	12	6,6	50	22	2325E-7	11,64
E8	9,8	12	7,0	50	25	2325E-8	11,64
E10	11,6	12	8,2	50	29	2325E-10	11,64

» 2325

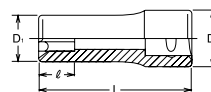

KOKEN IIIIII

○ VASOS HEXAGONALES CON ARTICULACIÓN UNIVERSAL

mm	pulgadas	D1	D2	ℓ	L	⚖	Ref Métrica	€	Ref Pulgadas	€
4		6,7	13	4,8	31,5	17	2440M4	21,70		
5		8,0	13	5,3	32	17	2440M5	21,70		
6		9,2	13	6,1	33	18	2440M6	21,70		
	1/4	9,8	13	6,5	33	18			2440A1/4	23,56
7		10,5	13	6,5	33	19	2440M7	21,70		
8	5/16	11,7	13	7,0	34	19	2440M8	21,70	2440A5/16	23,56
9		13,0	13	7,0	34	20	2440M9	21,70		
	3/8	13,7	13	8,3	35	20			2440A3/8	23,57
10		14,2	13	8,3	35	20	2440M10	21,70		
11	7/16	15,5	13	9,5	36	21	2440M11	21,70	2440A7/16	23,57
12		16,7	13	10	37	21	2440M12	21,35		
13	1/2	18,0	13	10,5	37	26	2440M13	21,46	2440A1/2	24,04
14	9/16	19,2	13	10,5	37	28	2440M14	21,46	2440A9/16	24,04

» 2440M » 2440A

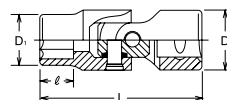
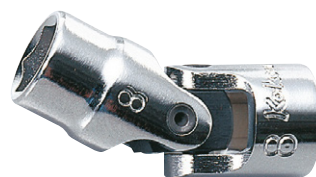

○ VASOS BIHEXAGONALES CON ARTICULACIÓN UNIVERSAL

mm	pulgadas	D1	D2	ℓ	L	⚖	Ref Métrica	€	Ref Pulgadas	€
4		6,7	13	4,8	31,5	17	2445M4	22,03		
5	3/16	8,0	13	5,3	32	17	2445M5	22,03	2445A3/16	23,54
6		9,2	13	6,1	33	18	2445M6	22,03		
	1/4	9,8	13	6,5	33	18			2445A1/4	23,56
7	9/32	10,5	13	6,5	33	19	2445M7	22,03	2445A9/32	23,54
8	5/16	11,7	13	7,0	34	19	2445M8	22,03	2445A5/16	23,55
9	11/32	13,0	13	7,0	34	20	2445M9	22,03	2445A11/32	
	3/8	13,7	13	8,3	35	20			2445A3/8	23,56
10		14,2	13	8,3	35	20	2445M10	22,03		
11	7/16	15,5	13	9,5	36	21	2445M11	22,03	2445A7/16	23,56
12		16,7	13	10,0	37	21	2445M12	26,01		
13	1/2	18,0	13	10,5	37	26	2445M13	26,01	2445A1/2	24,03
14	9/16	19,2	13	10,5	37	28	2445M14	26,01	2445A9/16	24,03

» 2445M » 2445A

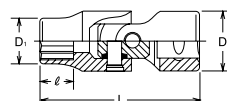
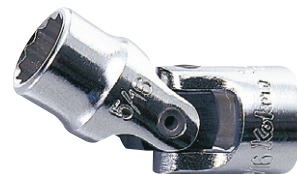

○ VASOS BIHEXAGONALES LARGOS CON ARTICULACIÓN UNIVERSAL, AS954E

pulgadas	D1	D2	ℓ	L	⚖	Ref	€
1/4	9,6	12,9	5,7	31,8	18	AS2445A1/4	25,09
5/16	11,7	12,9	7	34,6	21	AS2445A5/16	25,09
3/8	13,5	12,9	8,3	35,1	21	AS2445A3/8	25,46
7/16	15,5	12,9	9,5	39,1	25	AS2445A7/16	25,46
1/2	17,2	12,9	10,5	40,1	27	AS2445A1/2	26,04

» AS2445A

[Norma Aeroespacial SAE AS954E]

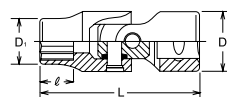

⊕ VASOS CON PUNTA PHILLIPS

PH	D	L	⚖	Ref	€
1	11,9	28	10	2000-28PH1	7,81
2	11,9	28	11	2000-28PH2	7,81
3	11,9	28	12	2000-28PH3	8,34
4	13,1	28	13	2000-28PH4	8,34

» 2000-28 (PH)

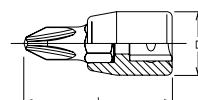

⊕ VASOS CON PUNTA PZ

PZ	D	L	⚖	Ref	€
PZ1	11,9	28	10	2000-28PZ1	8,74
PZ2	11,9	28	11	2000-28PZ2	8,74
PZ3	11,9	28	12	2000-28PZ3	8,74

» 2000-28 (PZ)

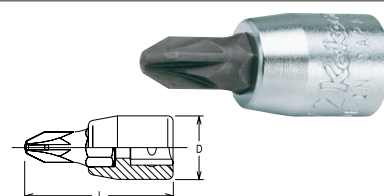

⊖ VASOS CON PUNTA RECTA PARA CABEZA RANURADA

nº	T x W	D	L	⚖	Ref	€
3	0,5 x 3	11,9	25	9	2005-253	6,67
4	0,8 x 4	11,9	25	10	2005-254	6,67
5	1,0 x 5,5	11,9	25	10	2005-255	6,67
6	1,2 x 6,5	13,1	25	11	2005-256	6,67
8	1,2 x 8	13,1	25	12	2005-258	6,67
9	1,6 x 8	13,1	25	12	2005-259	6,67
10	1,6 x 10	14,3	25	13	2005-2510	6,67

» 2005-25

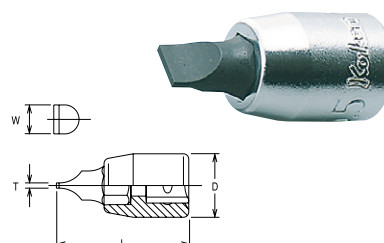

⊙ VASOS CON PUNTA HEXAGONAL

mm	pulgadas	D1	⚖		Ref	L25	€	L100	€	L25	€
			25	100							
1,5		11,9	9		2025	M25-1,5	5,71				
2		11,9	9	30	2025	M25-2	5,71	M100-2	8,87		
2,5		11,9	9	30	2025	M25-2,5	5,71	M100-2,5	8,87		
3	1/8	11,9	9	30	2025	M25-3	5,71	M100-3	8,87	A251/8	6,66
4	5/32	11,9	9	30	2025	M25-4	5,71	M100-4	8,87	A255/32	6,66
5	3/16	11,9	10	30	2025	M25-5	5,71	M100-5	8,87	A253/16	6,66
		11,9	11	35	2025					A257/32	6,66
6	1/4	11,9	12	35	2025	M25-6	5,71	M100-6	8,87	A251/4	6,66
7	9/32	13,1	12	35	2025	M25-7	6,08	M100-7	9,51	A259/32	6,66
8	5/16	13,1	14	38	2025	M25-8	6,08	M100-8	9,51	A255/16	6,66
10	3/8	14,3	17	45	2025	M25-10	6,08	M100-10	9,68	A253/8	6,66
12		16,4	36	107	2025	M25-12	7,77	M100-12	11,81		

» 2010M-25/-100 » 2010A-25

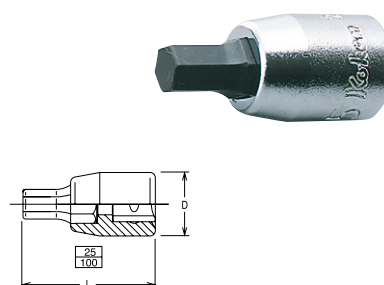

▤ ⊙ JUEGO DE VASOS EN REGLETA

Ref	Tipo	▤	⚖	▤	▤	€
RS2010M/7-L25	●2010M-25	150	115	7	3, 4, 5, 6, 7, 8, 10	36,27
RS2010A/8-L25	●2010A-25	150	130	8	1/8, 5/32, 3/16, 7/32, 1/4, 9/32, 5/16, 3/8	43,45

»RS2010M/7-L25 »RS2010A/8-L25



⊙ VASOS CON PUNTA TORX®

TORX®	D	⚖		Ref L28	€	Ref L80	€
		28	80				
T8	11,9	10		2025-28T8	9,77		
T9	11,9	10		2025-28T9	9,77		
T10	11,9	10	40	2025-28T10	9,77	2025-80T10	11,39
T15	11,9	10	40	2025-28T15	9,68	2025-80T15	11,39
T20	11,9	11	42	2025-28T20	9,68	2025-80T20	11,39
T25	11,9	11	42	2025-28T25	9,68	2025-80T25	11,39
T27	11,9	12	45	2025-28T27	9,68	2025-80T27	11,39
T30	11,9	12	45	2025-28T30	9,68	2025-80T30	11,39
T40	11,9	13	50	2025-28T40	12,28	2025-80T40	12,78

» 2025-28T/80T

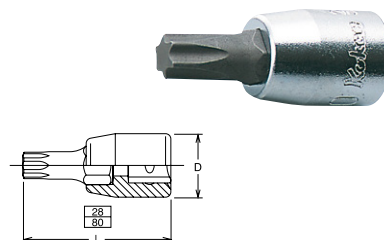

▤ ⊙ JUEGO DE VASOS EN REGLETA

Ref	Tipo	▤	⚖	▤	▤	€
RS2025/7-L28	●2025-28	150	119	7	T10, T15, T20, T25, T27, T30, T40	58,06

»RS2025/7-L28



⊗ VASOS CON PUNTA TORX® INVIOLEBLE

TH	D	L	⚖️	Ref	€
T10H	11,9	28	10	2025-28 TH10	10,98
T15H	11,9	28	10	2025-28 TH15	10,53
T20H	11,9	28	11	2025-28 TH20	10,53
T25H	11,9	28	11	2025-28 TH25	10,53
T27H	11,9	28	12	2025-28 TH27	10,53
T30H	11,9	28	12	2025-28 TH30	10,53
T40H	11,9	28	13	2025-28 TH40	13,29

» 2025-28 (TH)

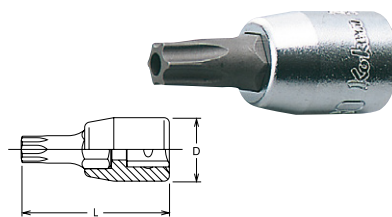

▤ ⊗ JUEGO DE VASOS EN REGLITA

Ref	Tipo	▤	⚖️	▤	▤	▤	€
RS2025/7-L28TH	⊗ 2025-28TH	150	119	7	T10H, T15H, T20H, T25H, T27H, T30H, T40H		64,67

» RS2025/7-L28TH



⊗ VASOS CON PUNTA TORX® PLUS INVIOLEBLE

IPR	D	L	⚖️	Ref	€
8IPR	11,9	28	10	2025-28 8IPR	7,98
9IPR	11,9	28	10	2025-28 9IPR	7,98
10IPR	11,9	28	10	2025-28 10IPR	7,98
15IPR	11,9	28	10	2025-28 15IPR	7,98
20IPR	11,9	28	11	2025-28 20IPR	7,98
25IPR	11,9	28	11	2025-28 25IPR	7,98
27IPR	11,9	28	12	2025-28 27IPR	7,98
30IPR	11,9	28	12	2025-28 30IPR	7,98
40IPR	13,1	28	13	2025-28 40IPR	7,98

» 2025-28 (IPR)

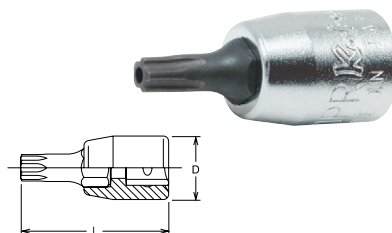

⊗ VASOS CON PUNTA XZN

M	D	⚖️		Ref L28	€	Ref L50	€
		28	50				
M4	11,9	12	20	2020-28 M4	9,96	2020-50 M4	11,06
M5	11,9	12	20	2020-28 M5	9,96	2020-50 M5	11,06
M6	11,9	13	22	2020-28 M6	9,79	2020-50 M6	11,06
M8	13,1	14	24	2020-28 M8	9,79	2020-50 M8	11,06

» 2020-28/-50

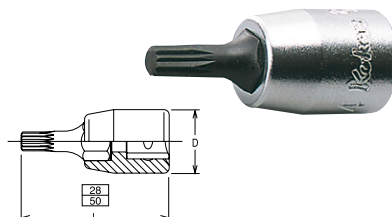

○ PORTA PUNTA

Ref	L	⚖️	€
2137	22,5	13	7,19

» 2137

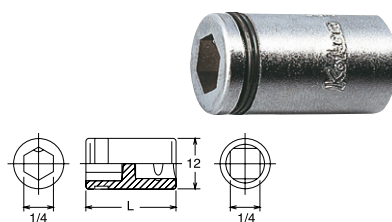

LLAVE DE CARRACA REVERSIBLE CORTA

Ref	Tipo	D	T	Dientes	L	⚖️	€
2753PS	2753	22	18,7	20	75	55	49,96

[Pack de repuestos 2753RK]



» 2753PS

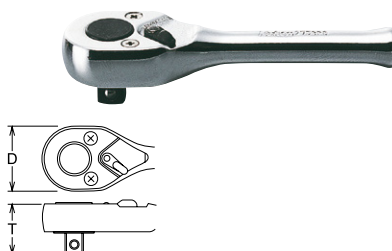

LLAVE DE CARRACA REVERSIBLE

Ref	Tipo	D	T	Dientes	L	⚖	€
2753J	2753	22	18,7	20	115	77	38,67

[Pack de repuestos 2753RK]



» 2753J

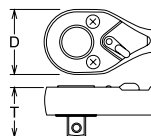

LLAVE DE CARRACA REVERSIBLE

Ref	Tipo	D	T	Dientes	L	⚖	€
2753P	2753	22	18,7	20	115	87	38,57

[Pack de repuestos 2753RK]



» 2753P

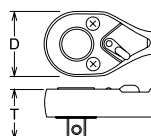

LLAVE DE CARRACA REVERSIBLE LARGA

Ref	Tipo	D	T	Dientes	L	⚖	€
2753P-160	2753	22	18,7	20	160	107	58,82

[Pack de repuestos 2753RK]



» 2753P-160

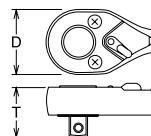

LLAVE DE CARRACA REVERSIBLE CON BOTÓN DE EXTRACCIÓN RÁPIDA*

Ref	Tipo	D	T	Dientes	L	⚖	€
2753JB	2753	22	18,7	20	115	77	50,15

*Los vasos y accesorios se bloquean en posición. Los vasos y alargaderas se extraen de la llave apretando el botón.

[Pack de repuestos 2753RK]



» 2753JB

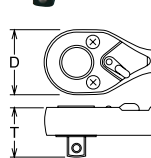

LLAVE DE CARRACA REVERSIBLE CON BOTÓN DE EXTRACCIÓN RÁPIDA*

Ref	Tipo	D	T	Dientes	L	⚖	€
2753PB	2753	22	18,7	20	115	87	52,55

*Los vasos y accesorios se bloquean en posición. Los vasos y alargaderas se extraen de la llave apretando el botón.

[Pack de repuestos 2753RK]



» 2753PB

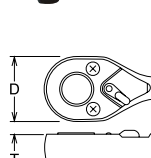

KOKEN IIIIII

LLAVE DE CARRACA ARTICULADA, REVERSIBLE

Ref	Tipo	D	T	Dientes	L	⚖	€
2774JS	2774	22	18,7	20	116	113	64,56

[Pack de repuestos 2753RK]



» 2774JS

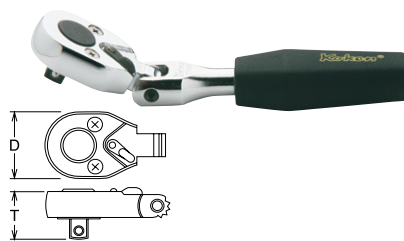

LLAVE DE CARRACA ARTICULADA, REVERSIBLE

Ref	Tipo	D	T	Dientes	L	⚖	€
2774P	2774	22	18,7	20	161	126	65,14

[Pack de repuestos 2753RK]



» 2774P

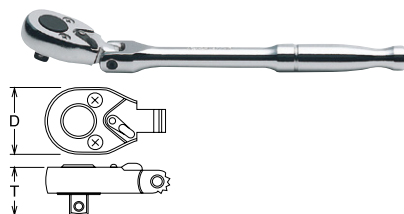

DISCO DE GIRO RÁPIDO

Ref	D	L	⚖	€
2756	22	20	19	14,21

» 2756

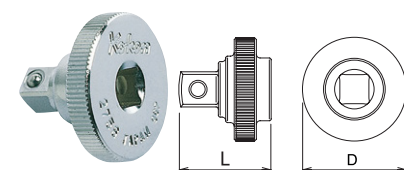

ALARGADERAS

Ref	D	L	⚖	€
2760-28	12,3	28	14	7,35
2760-50	12,3	50	23	7,35
2760-75	12,3	75	35	8,95
2760-100	12,3	100	44	8,98
2760-150	12,3	150	63	10,63
2760-200	12,3	200	83	14,04
2760-250	12,3	250	103	14,04
2760-300	12,3	300	122	17,99
2760-350	12,3	350	145	21,37
2760-400	12,3	400	160	21,37
2760-600	12,3	600	240	33,12

» 2760

-50/-75/-100/-150/-200/ -250/-300 /-350/-400/-600

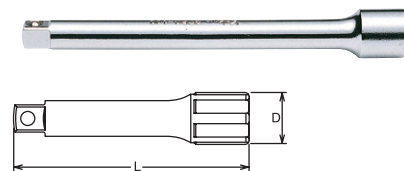

ALARGADERA FLEXIBLE

Ref	D	L	⚖	€
2762	13	300	90	25,46

» 2762

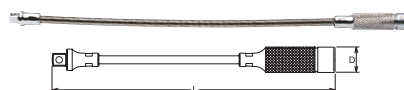

ALARGADERA ARTICULADA-FIJA*

Ref	D	L	⚖	€
2763-28	12,3	28	14	8,83
2763-50	12,3	50	23	11,36
2763-75	12,3	75	33	11,36
2763-100	12,3	100	43	13,16
2763-150	12,3	150	62	16,79
2763-200	12,3	200	80	17,17
2763-250	12,3	250	100	19,85

» 2763-28/-50/-75/-100

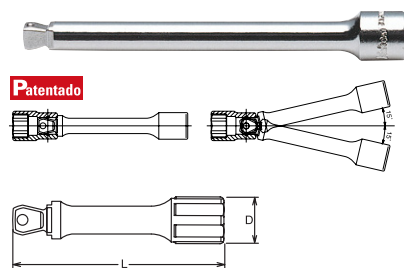

*Dos formas de utilización: Una como alargadera flexible para poder trabajar con un ángulo de 15° y otra para utilizarse como alargadera normal. Esta aplicación está patentada.



MANGO ARTICULADO

» 2768J

Ref	L	D	⚖	€
2768J	130	14	113	23,51

[Pack de repuestos 2768RK]



MANGO TIPO DESTORNILLADOR*

» 2769N-150/-220

Ref	L	ℓ	⚖	€
2769N-150	150	50	68	12,25
2769N-220	220	120	100	13,33

*Los mangos de plástico o de goma no están previstos para aislamiento.



Patentado

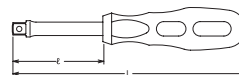

LLAVE DE VASO PLEGABLE

» 2769H

Ref	L	⚖	€
2769H	160	180	45,51

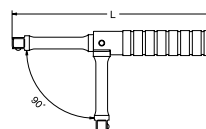

ARTICULACIÓN UNIVERSAL

» 2770

Ref	L	⚖	€
2770	33	20	17,33

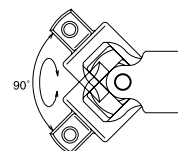

MANGO CORREDIZO

» 2785

Ref	L	⚖	€
2785	115	36	10,33



ADAPTADOR

» 2233A

Ref	L	⚖	€
2233A	22	16	7,65



□ 1/4" x □ 3/8"

JUEGO DE VASOS

Ref				€
ESH2001	160 x 100 x 28	16	630	124,56

Vasos

2410M	○ 4, 5, 5.5, 6, 7, 8, 9, 10, 11, 12, 13
-------	---

Accesorios

2753J	
2763-50	
2760-150	
2770	
2785	

» ESH2001



JUEGO DE VASOS

Ref				€
2251M	192 x 122 x 30	17	725	148,08

Vasos

2400M	○ 4, 5, 5.5, 6, 7, 8, 9, 10, 11, 12, 13
-------	---

Accesorios

2753J	
2760-50	
2760-150	
2768J	
2770	
2785	

» 2251M » 2251A



Ref				€
2251A	192 x 122 x 30	15	700	148,45

Vasos

2400A	○ 3/16, 7/32, 1/4, 9/32, 5/16, 11/32, 3/8, 7/16, 1/2
-------	--

Accesorios

2753J	
2760-50	
2760-150	
2768J	
2770	
2785	

JUEGO DE VASOS

Ref				€
2258M	240 x 100 x 32	31	965	241,21

Vasos

2400M	○ 4, 4.5, 5, 5.5, 6, 7, 8, 9, 10, 11, 12, 13
2000.28	⊕ 1, 2, 3
2005.25	⊖ 4, 6
2010M25	● 3, 4, 5, 6, 8
2025.28	● T10, T15, T20, T25, T30

Accesorios

2753J	
2760-100	
2769N-150	
2770	
2785	

» 2258M



JUEGO DE VASOS

Ref				€
2259M	240 x 100 x 32	31	991	270,98

Vasos

2400M	○ 4, 4.5, 5, 5.5, 6, 7, 8, 9, 10, 11, 12, 13
2000.28	⊕ 1, 2, 3
2005.25	⊖ 4, 6
2010M25	● 3, 4, 5, 6, 8
2025.28	● T10, T15, T20, T25, T30

Accesorios

2774JS	
2760-100	
2769N-150	
2770	
2785	

» 2259M



KOKEN IIIIII

JUEGO DE VASOS

Ref				€
P2201AM	245 x 120 x 45	25	790	143,94

Vasos

- 2410M ○ 4, 5, 5.5, 6, 7, 8, 9, 10, 11, 12, 13
- 2400A ○ 3/16, 7/32, 1/4, 9/32, 5/16, 11/32, 3/8, 7/16, 1/2

Accesorios

- 2753J
- 2760-100
- 2769N-150
- 2770
- 2785

» P2201AM



JUEGO DE VASOS

Ref				€
P2251M	245 x 120 x 45	17	725	138,47

Vasos

- 2400M ○ 4, 4.5, 5, 5.5, 6, 7, 8, 9, 10, 11, 12, 13

Accesorios

- 2753J
- 2760-50
- 2760-150
- 2768J
- 2770
- 2785

» P2251M



JUEGO DE VASOS

Ref				€
P2258M	245 x 120 x 45	31	850	209,93

Vasos

- 2400M ○ 4, 4.5, 5, 5.5, 6, 7, 8, 9, 10, 11, 12, 13
- 2000.28 ⊕ 1, 2, 3
- 2005.25 ⊖ 4, 6
- 2010M25 ● 3, 4, 5, 6, 8
- 2025.28 ⊛ T10, T15, T20, T25, T30

Accesorios

- 2753J
- 2760-100
- 2769N-150
- 2770
- 2785

» P2258M



○ VASOS HEXAGONALES

mm	pulgadas	D1	D2	ℓ	L	⚖	Ref Métrica	€	Ref Pulgadas	€
5		8,3	17,3	5	26	20	3400M5	4,05		
5,5		8,9	17,3	5,5	26	20	3400M5,5	4,05		
	3/16								3400A3/16	4,28
	9/32								3400A9/32	4,28
6		9,9	17,3	6	26	20	3400M6	4,05		
	1/4								3400A1/4	4,28
7		10,8	17,3	6,5	26	20	3400M7	4,05		
8	5/16	12,0	17,3	7	26	22	3400M8	4,05	3400A5/16	4,28
9	11/32	13,3	17,3	7,5	26	23	3400M9	4,05	3400A11/32	4,28
	3/8								3400A3/8	4,28
10		14,5	17,3	8	26	24	3400M10	4,05		
11	7/16	15,8	17,3	8,5	26	25	3400M11	4,05	3400A7/16	4,28
12		16,8	17,3	9	26	25	3400M12	4,05		
13	1/2	18,0	18,0	9,5	26	24	3400M13	4,75	3400A1/2	5,08
14	9/16	19,5	19,5	11	27	31	3400M14	4,75	3400A9/16	5,08
15	19/32	30,8	20,8	11,5	28	39	3400M15	4,75	3400A19/32	5,08
16	5/8	22,0	22,0	12	28	42	3400M16	4,75	3400A5/8	5,08
17		23,3	23,3	12,5	29	51	3400M17	4,75		
18	11/16	24,5	24,5	13	30	51	3400M18	4,75	3400A11/16	5,08
19	3/4	25,8	25,8	13,5	30	63	3400M19	4,92	3400A3/4	5,08
20	25/32	27,0	27,0	14	31	75	3400M20	6,13	3400A25/32	6,46
21	13/16	28,0	28,0	14,5	32	77	3400M21	6,13	3400A13/16	6,46
22	7/8	29,5	29,5	15	32	82	3400M22	6,13	3400A7/8	6,46
23		30,8	30,8	15,5	33	95	3400M23	6,61		
24	15/16	32,0	32,0	16	34	102	3400M24	6,74	3400A15/16	7,17
25	1	33,3	33,3	16,5	34	115	3400M25	10,44	3400A1	8,66
26		34,5	34,5	17	35	129	3400M26	10,44		

» 3400M » 3400A

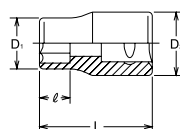

○ VASOS BIHEXAGONALES

mm	pulgadas	D1	D2	ℓ	L	⚖	Ref Métrica	€	Ref Pulgadas	€
5		8,3	17,3	5	26	20	3405M5	4,05		
5,5		8,9	17,3	5,5	26	20	3405M5,5	4,05		
	3/16								3405A3/16	4,28
	9/32								3405A9/32	4,28
6		9,9	17,3	6	26	20	3405M6	4,05		
	1/4								3405A1/4	4,28
7		10,8	17,3	6,5	26	20	3405M7	4,05		
8	5/16	12,0	17,3	7	26	22	3405M8	4,05	3405A5/16	4,28
9	11/32	13,3	17,3	7,5	26	23	3405M9	4,05	3405A11/32	4,28
	3/8								3405A3/8	4,28
10		14,5	17,3	8	26	24	3405M10	4,05		
11	7/16	15,8	17,3	8,5	26	25	3405M11	4,05	3405A7/16	4,28
12		16,8	17,3	9	26	25	3405M12	4,05		
13	1/2	18,0	18,0	9,5	26	24	3405M13	4,75	3405A1/2	5,08
14	9/16	19,5	19,5	11	27	31	3405M14	4,75	3405A9/16	5,08
15	19/32	30,8	20,8	11,5	28	39	3405M15	4,75	3405A19/32	5,08
16	5/8	22,0	22,0	12	28	42	3405M16	4,75	3405A5/8	5,08
17		23,3	23,3	12,5	29	51	3405M17	4,75		
18	11/16	24,5	24,5	13	30	51	3405M18	4,75	3405A11/16	5,08
19	3/4	25,8	25,8	13,5	30	63	3405M19	4,92	3405A3/4	5,08
20	25/32	27,0	27,0	14	31	75	3405M20	6,13	3405A25/32	6,46
21	13/16	28,0	28,0	14,5	32	77	3405M21	6,13	3405A13/16	6,46
22	7/8	29,5	29,5	15	32	82	3405M22	6,13	3405A7/8	6,46
23		30,8	30,8	15,5	33	95	3405M23	6,61		
24	15/16	32,0	32,0	16	34	102	3405M24	6,74	3405A15/16	7,35
25	1	33,3	33,3	16,5	34	115	3405M25	10,44	3405A1	8,66
26		34,5	34,5	17	35	129	3405M26	10,44		

» 3405M » 3405A

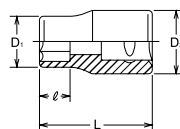

▤ ○ ○ JUEGO DE VASOS EN REGLETA

Ref	Tipo	▤	○	○	▤	€
RS3400M/12	○ 3400M	465	222	12	8, 9, 10, 11, 12, 13, 14, 15, 16, 17, 18, 19	49,10
RS3405M/12	○ 3405M	465	222	12	8, 9, 10, 11, 12, 13, 14, 15, 16, 17, 18, 19	49,10

» RS3400M/12 » RS3405M/12



||||| ○ ○ JUEGO DE VASOS EN REGLETA

» RS3400A/9 » RS3405A/9

Ref	Tipo		○	○		€
RS3400A/12	○ 3400A	250	333	9	1/4, 5/16, 3/8, 7/16, 1/2, 9/16, 5/8, 11/16, 3/4	39,19
RS3405A/12	○ 3405A	250	333	9	1/4, 5/16, 3/8, 7/16, 1/2, 9/16, 5/8, 11/16, 3/4	38,48



○ VASOS SURFACE DRIVE (DE CONTACTO CURVO)

» 3410M

mm	D1	D2	ℓ	L	⚖	Ref	€
5,5	8,9	17,3	5,5	26	20	3410M5,5	4,15
6	9,9	17,3	6	26	20	3410M6	4,15
7	10,8	17,3	6,5	26	20	3410M7	4,15
8	12,0	17,3	7	26	22	3410M8	4,15
9	13,3	17,3	7,5	26	23	3410M9	4,15
10	14,5	17,3	8	26	24	3410M10	4,15
11	15,8	17,3	8,5	26	25	3410M11	4,15
12	16,8	17,3	9	26	25	3410M12	4,15
13	18,0	17,0	9,5	26	24	3410M13	4,92
14	19,5	18,5	11	27	31	3410M14	4,92
15	20,8	19,5	11,5	28	39	3410M15	4,92
16	22,0	20,0	12	28	42	3410M16	4,92
17	23,3	21,5	12,5	29	51	3410M17	4,92
18	24,5	22,5	13	30	51	3410M18	4,92
19	25,8	23,5	13,5	30	63	3410M19	4,92
20	27,0	24,5	14	31	75	3410M20	6,31
21	28,0	26,0	14,5	32	77	3410M21	6,31
22	29,5	26,5	15	32	82	3410M22	6,31
23	30,8	27,5	15,5	33	95	3410M23	6,61
24	32,0	28,5	16	34	102	3410M24	6,74

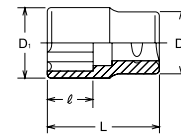

||||| ○ ○ JUEGO DE VASOS EN REGLETA

» RS3410M/12

Ref	Tipo		○	○		€
RS3410M/12	○ 3410M	300	468	12	8, 9, 10, 11, 12, 13, 14, 15, 16, 17, 18, 19	50,56



○ VASOS HEXAGONALES WHITWORTH

» 3400W

pulgadas	D1	D2	ℓ	L	⚖	Ref	€
1/8"	13,3	17,3	7,5	26	22	3400W1/8	5,08
3/16"	15,8	17,3	8,5	26	25	3400W3/16	5,08
1/4"	18	17	9,5	26	24	3400W1/4	5,67
5/16"	20,8	19,5	11,5	28	39	3400W5/16	5,7
3/8"	24,5	22,5	13	30	51	3400W3/8	5,67
7/16"	28	26	14,5	32	81	3400W7/16	7,38
1/2"	30,8	27,5	15,5	33	103	3400W1/2	7,82
9/16"	34,5	30,5	17	35	128	3400W9/16	9,05

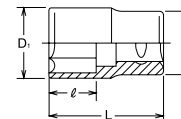

○ VASOS BIHEXAGONALES WHITWORTH

» 3405W

pulgadas	D1	D2	ℓ	L	⚖	Ref	€
1/8"	13,3	17,3	7,5	26	22	3405W1/8	5,08
3/16"	15,8	17,3	8,5	26	25	3405W3/16	5,08
1/4"	18	17	9,5	26	24	3405W1/4	5,67
5/16"	20,8	19,5	11,5	28	39	3405W5/16	5,7
3/8"	24,5	22,5	13	30	51	3405W3/8	5,67
7/16"	28	26	14,5	32	81	3405W7/16	7,38
1/2"	30,8	27,5	15,5	33	103	3405W1/2	7,82
9/16"	34,5	30,5	17	35	128	3405W9/16	9,05

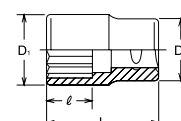
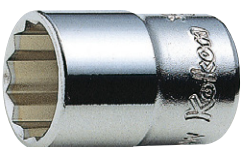

VASOS OCTOGONALES

mm	pulgadas	D1	D2	ℓ	L	⚖	Ref Métrica	€	Ref Pulgadas	€
5,5		10,8	17,4	5,5	26	21	3415M5,5	6,94		
6	1/4	12	17,3	6	26	26	3415M6	4,12	3415A1/4	5,20
7		13,3	17,4	6,5	26	26	3415M7	4,12		
8	5/16	14,5	17,3	7	26	26	3415M8	4,65	3415A5/16	5,20
	11/32	15,8	17,3	7,5	26	27			3415A11/32	5,67
10	3/8	16,8	17,3	8	26	27	3415M10	5,20	3415A3/8	5,20
	7/16	19,5	18,5	8,5	27	37			3415A7/16	5,20
12		20,8	19,5	9	27	43	3415M12	6,79		
13	1/2	21,9	20	9,5	27	46	3415M13	9,77	3415A1/2	6,00

» 3415M » 3415A

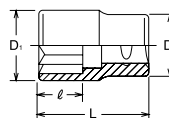

VASOS TORX®

TORX®	D1	D2	ℓ	L	⚖	Ref	€
E4	5,6	17,3	4,6	26	18	3425E-4	6,24
E5	7	17,3	5,2	26	20	3425E-5	6,24
E6	8,3	17,3	5,4	26	21	3425E-6	5,96
E7	8,9	17,3	6,6	26	22	3425E-7	5,96
E8	9,9	17,3	7	26	23	3425E-8	5,96
E10	12	17,3	8,2	26	24	3425E-10	5,96
E11	13,3	17,3	8,7	26	25	3425E-11	5,96
E12	14,5	17,3	9,3	26	26	3425E-12	5,96
E14	15,8	17,3	10,6	26	27	3425E-14	5,96
E16	18	17	11,8	26	27	3425E-16	6,35

» 3425

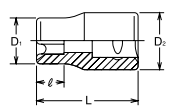

JUEGO DE VASOS EN REGLETA

Ref	Tipo	⚖	⚖	⚖	⚖	€
RS3425/9	3425	200	239	9	E4, E5, E6, E7, E8, E10, E12, E14, E16	42,08

» RS3425/9



JUEGO DE VASOS EN REGLETA

Ref	Tipo	⚖	⚖	⚖	⚖	Pulgadas	€
RSX425/14	2425	300	550	14		E4, E5, E6, E7, E8	1/4
	3425					E10, E11, E12, E14	3/8
	4425					E16, E18, E20, E22, E24	1/2

» RSX425/14



$\frac{1}{4} + \frac{3}{8} + \frac{1}{2}$

VASOS SUJETA-TUERCAS NUT GRIP®

mm	D1	D2	ℓ	L	⚖	Ref	€
8	12	17,3	5	26	21	3450M8	8,67
10	14,5	17,3	6	26	24	3450M10	8,67
11	15,8	17,3	6,5	26	26	3450M11	8,67
12	16,8	17,3	7	26	26	3450M12	8,67
13	18	17	8	26	28	3450M13	8,97
14	19,5	18,5	8,5	27	34	3450M14	8,97
15	20,8	19,5	9	27	42	3450M15	8,97
17	23,3	21,5	9,5	28	52	3450M17	8,97
19	25,8	23,3	11,5	29	66	3450M19	9,32
21	28	26	12	29	85	3450M21	9,97
22	29,5	27	12,5	29	90	3450M22	9,97
24	32	30	14,5	31	102	3450M24	11,27

» 3450M

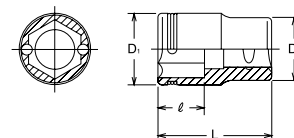

JUEGO DE VASOS EN REGLETA

Ref	Tipo	⚖	⚖	⚖	⚖	€
RS3450M/8	3450M	200	310	8	8, 10, 11, 12, 13, 14, 17, 19	48,59

» RS3450M/8



○ VASOS HEXAGONALES MEDIANOS

» 3300X

mm	D1	D2	ℓ	L	⚖	Ref	€
8	12	17,3	9	40	34	3300X8	7,52
9	13	17,3	10	40	36	3300X9	7,52
10	14,5	17,3	11	40	36	3300X10	7,52
11	16	17,3	12	40	36	3300X11	7,52
12	16,8	17,2	13	40	36	3300X12	7,52
13	18	17	14	40	37	3300X13	8,60
14	20	18	16	40	46	3300X14	8,38
15	21	20	16	40	49	3300X15	8,60
16	22	20	17	40	51	3300X16	8,60
17	23,5	22	18	40	61	3300X17	8,60
18	24,5	23	19	40	68	3300X18	9,35
19	25	24	20	40	75	3300X19	9,35

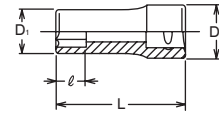

○ VASOS HEXAGONALES LARGOS

» 3300M » 3300A

mm	pulgadas	D1	D2	ℓ	L	⚖	Ref Métrica	€	Ref Pulgadas	€
5,5	7/32	8,9	17,3	6,5	55	37	3300M5,5	8,27	3300A7/32	8,76
6	1/4	9,9	17,3	7	55	37	3300M6	8,27	3300A1/4	8,76
7		10,6	17,3	8	55	37	3300M7	8,27		
8	5/16	12	17,3	9	55	40	3300M8	8,27	3300A5/16	8,76
	11/32	12,3	17,3	10	55	41			3300A11/32	8,76
9		13	17,3	10	55	42	3300M9	8,27		
	3/8	14	17,3	11	55	46			3300A3/8	8,76
10		14,5	17,3	11	55	46	3300M10	8,27		
11	7/16	16	17,2	12	55	51	3300M11	8,27	3300A7/16	8,76
12		16,8	17,2	13	55	52	3300M12	8,27		
13	1/2	18	17	14	55	53	3300M13	9,22	3300A1/2	9,70
14	9/16	20	18	16	55	60	3300M14	9,22	3300A9/16	9,70
15	19/32	21	20	16	55	74	3300M15	9,22	3300A19/32	9,70
16	5/8	22	20	17	55	76	3300M16	9,22	3300A5/8	9,70
17	11/16	23,5	22	18	55	93	3300M17	9,22	3300A11/16	10,11
18		24,5	23	19	55	98	3300M18	10,93		
19	3/4	25	24	20	55	98	3300M19	10,93	3300A3/4	11,53
20		26	25	21	65	126	3300M20	10,93		
21	13/16	27	26	22	65	126	3300M21	12,61	3300A13/16	13,21
22	7/8	29	28	23	65	163	3300M22	12,61	3300A7/8	13,21
23		30	29	24	65	168	3300M23	12,61		
24	15/16	31	30	25	65	191	3300M24	14,72	3300A15/16	15,36
25		33	30	26	65	199	3300M25	14,72		
26		34	31	27	65	209	3300M26	14,72		
27		35	32,5	28	65	218	3300M27	16,73		

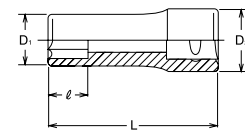

KOKEN IIIIII

○ VASOS BIHEXAGONALES LARGOS

mm	pulgadas	D1	D2	ℓ	L	⚖	Ref Métrica	€	Ref Pulgadas	€
5,5	7/32	8,9	17,3	6,5	55	37	3305M5,5	8,27	3305A7/32	8,76
6	1/4	9,9	17,3	7	55	37	3305M6	8,27	3305A1/4	8,76
7		10,6	17,3	8	55	37	3305M7	8,27		
8	5/16	12	17,3	9	55	40	3305M8	8,27	3305A5/16	8,76
	11/32	12,3	17,3	10	55	41			3305A11/32	8,76
9		13	17,3	10	55	42	3305M9	8,27		
	3/8	14	17,3	11	55	46			3305A3/8	8,76
10		14,5	17,3	11	55	46	3305M10	8,27		
11	7/16	16	17,2	12	55	51	3305M11	8,27	3305A7/16	8,76
12		16,8	17,2	13	55	52	3305M12	8,27		
13	1/2	18	17	14	55	53	3305M13	9,22	3305A1/2	9,70
14	9/16	20	18	16	55	60	3305M14	9,22	3305A9/16	9,70
15	19/32	21	20	16	55	74	3305M15	9,22	3305A19/32	9,70
16	5/8	22	20	17	55	76	3305M16	9,22	3305A5/8	9,70
17	11/16	23,5	22	18	55	93	3305M17	9,22	3305A11/16	10,13
18		24,5	23	19	55	98	3305M18	10,93		
19	3/4	25	24	20	55	98	3305M19	10,93	3305A3/4	11,53
20		26	25	21	65	126	3305M20	10,93		
21	13/16	27	26	22	65	126	3305M21	12,61	3305A13/16	13,21
22	7/8	29	28	23	65	163	3305M22	12,61	3305A7/8	13,21
23		30	29	24	65	168	3305M23	12,61		
24	15/16	31	30	25	65	191	3305M24	14,72	3305A15/16	15,36
25		33	30	26	65	199	3305M25	15,90		
26		34	31	27	65	209	3305M26	15,90		
27		35	32,5	28	65	218	3305M27	16,74		

» 3305M » 3305A

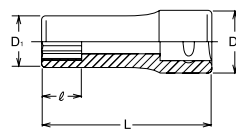

▤ ○ ○ JUEGO DE VASOS EN REGLETA

Ref	Tipo	▤	⚖	▤	▤	€
RS3400M/12	○ 3400M	465	222	12	8, 9, 10, 11, 12, 13, 14, 15, 16, 17, 18, 19	99,38
RS3405M/12	○ 3405M	465	222	12	8, 9, 10, 11, 12, 13, 14, 15, 16, 17, 18, 19	99,38

» RS3300M/12 » RS3305M/12



▤ ○ ○ JUEGO DE VASOS EN REGLETA

Ref	Tipo	▤	⚖	▤	▤	€
RS3400A/12	○ 3400A	250	333	9	1/4, 5/16, 3/8, 7/16, 1/2, 9/16, 5/8, 11/16, 3/4	77,90
RS3405A/12	○ 3405A	250	333	9	1/4, 5/16, 3/8, 7/16, 1/2, 9/16, 5/8, 11/16, 3/4	77,90

» RS3300A/9 » RS3305A/9



○ VASOS SURFACE DRIVE (DE CONTACTO CURVO) LARGOS

mm	D1	D2	ℓ	L	⚖	Ref	€
6	9,9	17,3	7	55	37	3310M6	8,62
7	10,6	17,3	8	55	37	3310M7	8,62
8	12	17,3	9	55	40	3310M8	8,62
9	13	17,3	10	55	42	3310M9	8,62
10	14,5	17,3	11	55	46	3310M10	8,62
11	16	17,3	12	55	51	3310M11	8,62
12	16,98	17,2	13	55	52	3310M12	8,62
13	18	17	14	55	53	3310M13	9,70
14	20	18	16	55	60	3310M14	9,70
15	21	20	16	55	74	3310M15	9,70
16	22	20	17	55	76	3310M16	9,70
17	23,5	22	18	55	93	3310M17	9,70
18	24,5	23	19	55	98	3310M18	11,19
19	25	24	20	55	98	3310M19	11,19
20	26	25	21	65	126	3310M20	11,19
21	27	26	22	65	126	3310M21	12,77
22	29	28	23	65	163	3310M22	12,77
23	30	29	24	65	168	3310M23	12,77
24	31	30	25	65	191	3310M24	15,24

» 3310M

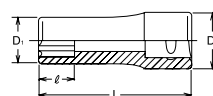

○ VASOS HEXAGONALES WHITWORTH

pulgadas	D1	D2	ℓ	L	⚖	Ref	€
1/8"	12,3	17,3	10	55	46	3300W1/8	9,98
3/16"	16	17,3	12	55	55	3300W3/16	9,98
1/4"	18	17	14	55	57	3300W1/4	11,21
5/16"	21	20	16	55	79	3300W5/16	11,21
3/8"	24,5	23	19	55	96	3300W3/8	13,21
7/16"	27	26	22	65	140	3300W7/16	15,05
1/2"	30	29	24	65	193	3300W1/2	15,05
9/16"	34	31	27	65	250	3300W9/16	20,12

» 3300W

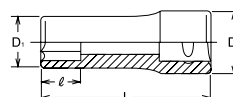

⊕ VASOS TORX®

TORX®	D1	D2	ℓ	L	⚖	Ref	€
E4	5,6	17,3	4,6	26	29	3325E-4	11,85
E5	6,9	17,3	5,2	26	31	3325E-5	11,85
E6	7,9	17,3	5,4	26	33	3325E-6	11,36
E7	8,9	17,3	6,6	26	36	3325E-7	11,36
E8	9,9	17,3	7	26	39	3325E-8	11,36
E10	11,8	17,3	8,2	26	43	3325E-10	11,36
E12	14,5	17,2	9,3	26	53	3325E-12	11,36
E14	15,7	17,2	10,6	26	57	3325E-14	11,36
E16	18	17	11,8	26	69	3325E-16	12,00

» 3325

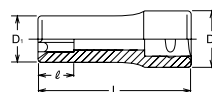

▄ ○ JUEGO DE VASOS EN REGLETA

Ref	Tipo	▄	⚖	▄	▄	€
RS3325/9	⊕ 3325	200	420	9	E4, E5, E6, E7, E8, E10, E12, E14, E16	87,36

» RS3325/9



○ LLAVES DE VASO PARA ENTUBAR

mm	D1	D2	ℓ	L	⚖	Ref	€
8	14,5	17,3	6	53	38	3300FN8	45,40
9	16	17,3	7	53	41	3300FN9	45,40
10	16,8	17,2	7,5	53	42	3300FN10	45,40
11	18	17	8,5	53	42	3300FN11	45,40
12	20	18	9	53	50	3300FN12	45,40
13	21,1	20	9,5	62	66	3300FN13	46,14
14	22	20	10,5	62	66	3300FN14	47,07
15	23	22	11	70	82	3300FN15	47,62
16	24	23	11,5	70	90	3300FN16	47,62
17	25	24	12,5	80	110	3300FN17	48,46
18	27	25	13	80	120	3300FN18	49,36
19	28	26	14	80	130	3300FN19	49,83
22	32	29,5	16	80	180	3300FN22	49,83
24	34,5	31,5	17	80	200	3300FN24	49,83

» 3300FN

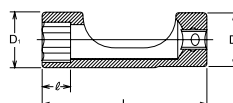

▄ ○ JUEGO DE VASOS EN REGLETA

Ref	Tipo	▄	⚖	▄	▄	€
RS3300FN/8	⊕ 3300FN	200	600	8	9, 10, 11, 13, 14, 16, 17, 19	299,04

» RS3300FN/8



○ LLAVES DE BUJÍA CON GOMA

» 3300S

mm	D	ℓ	L	⚖	Ref	€
16	20,9	19	70	101	3300S16	13,66
18	23,9	21	70	105	3300S18	15,24
20,8	26,9	27	70	130	3300S20,8	15,24

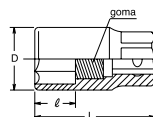

○ LLAVES DE BUJÍA CON IMÁN. BOCA BIHEXAGONAL

» 3305P

mm	D	ℓ	L	⚖	Ref	€
14	19	8	70	87	3305P14	23,61
16	20,5	8	70	100	3305P16	30,71

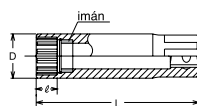
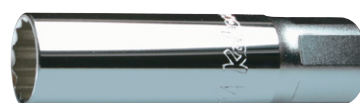

○ LLAVE DE BUJÍA CON PRESILLAS

» 3300C

mm	D	ℓ	L	⚖	Ref	€
13	17,5	11	70	66	3300C13	21,35
14	19	11	70	82	3300C14	22,86
16	20,5	13	70	91	3300C16	22,86
18	23,9	12	70	140	3300C18	23,05
20,8	26,9	13,5	70	132	3300C20,8	26,95

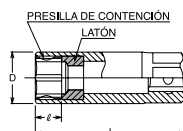

Patentado

3300C-13 para Citroen C2 y C3
3300C-14 para Peugeot 406 / Citroen C5 / Renault Twingo, Clio II

○ VASOS HEXAGONALES CON ARTICULACIÓN UNIVERSAL

» 3440M » 3440A

mm	pulgadas	D1	D2	ℓ	L	⚖	Ref Métrica	€	Ref Pulgadas	€
8	5/16	12	19	7,3	47	50	3440M8	22,41	3440A5/16	23,54
9		13,3	19	7,8	47,5	50	3440M9	22,41		
	3/8	14	19	8,3	48	64			3440A3/8	23,54
10		14,5	19	8,8	48,5	64	3440M10	22,41		
11	7/16	15,8	19	9,8	49,5	66	3440M11	22,41	3440A7/16	23,54
12		17	19	10,3	50	67	3440M12	22,73		
13	1/2	18,3	19	11,3	51	68	3440M13	22,73	3440A1/2	23,89
14	9/16	19,5	19	11,3	51	69	3440M14	23,70	3440A9/16	24,83
15		20,8	19	12,8	53,5	70	3440M15	28,90		
16	5/8	22	19	12,8	53,5	77	3440M16	23,70	3440A5/8	24,84
17		23,3	19	13,8	54,5	80	3440M17	24,18		
18	11/16	24,5	19	13,8	54,5	80	3440M18	25,02	3440A11/16	26,32
19	3/4	25,8	19	15,8	56,5	84	3440M19	25,03	3440A3/4	26,32
21		28,3	19	16,8	56,5	96	3440M21	32,21		

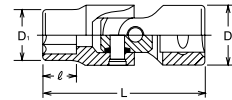
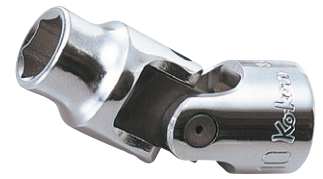

○ VASOS BIHEXAGONALES CON ARTICULACIÓN UNIVERSAL

» 3445M » 3445A

mm	pulgadas	D1	D2	ℓ	L	⚖	Ref Métrica	€	Ref Pulgadas	€
8	5/16	12	19	7,3	47	50	3445M8	22,41	3445A5/16	23,54
9		13,3	19	7,8	47,5	50	3445M9	22,41		
	3/8	14	19	8,3	48	64			3445A3/8	23,54
10		14,5	19	8,8	48,5	64	3445M10	22,41		
11	7/16	15,8	19	9,8	49,5	66	3445M11		3445A7/16	23,54
12		17	19	10,3	50	67	3445M12	22,73		
13	1/2	18,3	19	11,3	51	68	3445M13	22,73	3445A1/2	23,88
14	9/16	19,5	19	11,3	51	69	3445M14	23,70	3445A9/16	24,83
15		20,8	19	12,8	53,5	70	3445M15			
16	5/8	22	19	12,8	53,5	77	3445M16	23,70	3445A5/8	24,83
17		23,3	19	13,8	54,5	80	3445M17	23,70		
18	11/16	24,5	19	13,8	54,5	80	3445M18	25,02	3445A11/16	26,33
19	3/4	25,8	19	15,8	56,5	84	3445M19	25,02	3445A3/4	26,33
21		28,3	19	16,8	56,5	96	3445M21	32,21		

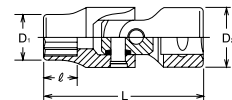

○ LLAVES DE BUJÍA CON PRESILLAS CON ARTICULACIÓN UNIVERSAL

» 3340C

mm	D1	D2	ℓ	L	⚖	Ref	€
14	19	19	11	88	109	3340C14	51,92
16	21	19	13	88	122	3310C16	51,92
18	23,9	19	12	88	145	3340C18	51,92
20,8	26,8	19	14	88	174	3340C20,8	63,83



● VASOS INHEx CON ARTICULACIÓN UNIVERSAL

» 3430M

mm	D	ℓ	L	⚖	Ref	€
5	19	15,5	62	66	3430M5	23,88
6	19	15,5	62	70	3430M6	23,88
7	19	15,5	62	72	3430M7	23,88
8	19	15,5	62	74	3430M8	23,88
10	19	15,5	62	78	3430M10	23,88
12	19	15,5	62	85	3430M12	23,88

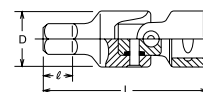

○ VASOS CON ALARGADERA

mm	D1	D2	ℓ	⚖		Ref L125	€	Ref L250	€
				125	250				
10	14,5	18	10	121	233	3117M-12510	20,69	3117M-25010	24,07
11	16	18	11	133	241	3117M-12511	20,69	3117M-25011	24,07
12	17	18	12	133	246	3117M-12512	20,69	3117M-25012	24,07
13	18	18	13	134	249	3117M-12513	21,61	3117M-25013	25,00
14	19,5	18	14	145	262	3117M-12514	21,61	3117M-25014	25,00
17	23,5	18	17	178	289	3117M-12517	21,61	3117M-25017	25,00
19	25	18	19	187	298	3117M-12519	22,49	3117M-25019	25,92
21	27	18	21	195	302	3117M-12521	24,55	3117M-25021	27,60
22	29	18	22	214	325	3117M-12522	24,55	3117M-25022	27,60

» 3117M-125/-250

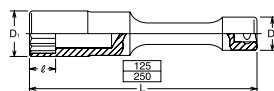

○ LLAVES DE BUJÍA CON PRESILLAS

mm	D1	D2	ℓ	⚖		Ref L125	€	Ref L250	€
				125	250				
14	19	18	11	205	271	3300C-18014	39,71	3300C-25014	39,13
16	20,5	18	13	220	290	3300C-18016	43,46	3300C-25016	39,13
20,8	26,9	18	13,5	260	340	3300C-18020,8	54,12	3300C-25020,8	54,12

» 3300C-180/-250



Patentado

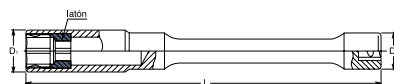

⊕ VASOS CON PUNTA PHILLIPS

PH	D	L	⚖	Ref	€
1	18	60	49	3000-60PH1	9,15
2	18	60	49	3000-60PH2	9,15
3	18	60	49	3000-60PH3	9,15
4	18	60	50	3000-60PH4	9,15

» 3000-60 (PH)

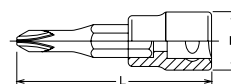

⊕ VASOS CON PUNTA PZ

PZ	D	L	⚖	Ref	€
PZ1	18	50	50	3000-50PZ1	10,20
PZ2	18	50	50	3000-50PZ2	10,20
PZ3	18	50	50	3000-50PZ3	10,20

» 3000-50 (PZ)

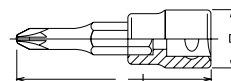

⊖ VASOS CON PUNTA RECTA PARA CABEZA RANURADA

nº	T x W	D	L	⚖	Ref	€
5	1,0 x 5,5	18	60	47	3005-605	12,17
8	1,2 x 8	18	60	49	3005-608	12,17
10	1,6 x 10	18	60	85	3005-6010	12,81

» 3005-60

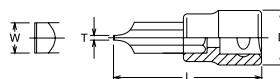

● VASOS CON PUNTA HEXAGONAL

mm	D	⚖				Ref	L38	€	L62	€	L100	€	L160	€
		38	62	100	160									
3	18	27	43	58	84	3010	M38-3	8,14	M62-3	8,27	M100-3	8,76	M160-3	10,60
4	18	28	45	60	86	3010	M38-4	8,14	M62-4	8,27	M100-4	8,76	M160-4	10,60
5	18	30	48	63	89	3010	M38-5	8,14	M62-5	8,27	M100-5	8,76	M160-5	10,62
6	18	31	49	64	90	3010	M38-6	8,14	M62-6	8,27	M100-6	8,76	M160-6	10,62
7	18	32	50	66	92	3010	M38-7	8,14	M62-7	8,76	M100-7	9,37	M160-7	11,37
8	18	33	52	69	95	3010	M38-8	8,14	M62-8	8,76	M100-8	9,37	M160-8	11,37
9	20	47	75	100	125	3010	M38-9	8,60	M62-9	8,76	M100-9	9,52	M160-9	11,37
10	20	48	76	102	128	3010	M38-10	8,60	M62-10	9,09	M100-10	9,52	M160-10	11,84
12	20	60	94	131	157	3010	M38-12	8,90	M62-12	9,37	M100-12	10,13	M160-12	12,61
13	22	76	107	158	237	3010	M38-13	8,90	M62-13	9,37	M100-13	10,13	M160-13	12,61
14	22	78	109	160	239	3010	M38-14	8,90	M62-14	9,37	M100-14	10,13	M160-14	12,61

» 3010M-38/-62/-100/-160

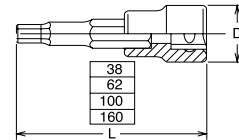
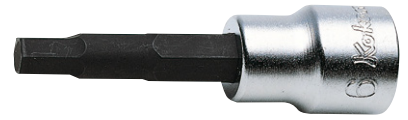

● VASOS CON PUNTA HEXAGONAL

mm	D	ℓ	⚖			Ref	L52	€	L62	€	L75	€
			52	62	75							
3	18	10	35	38	41	3012M	52-3	10,53	62-3	11,17	75-3	11,64
4	18	15,5	38	40	43	3012M	52-4	10,27	62-4	11,17	75-4	11,64
5	18	15,5	40	43	48	3012M	52-5	10,53	62-5	11,17	75-5	11,64
6	18	15,5	42	46	53	3012M	52-6	10,53	62-6	11,53	75-6	11,64
7	18	15,5	46	53	67	3012M	52-7	10,75	62-7	11,53	75-7	11,64
8	18,5	15,5	50	58	72	3012M	52-8	10,75	62-8	11,53	75-8	11,64
9	18,5	15,5	55	63	92	3012M	52-9	10,75	62-9	11,84	75-9	12,28
10	20	15,5	66	77	114	3012M	52-10	10,75	62-10	11,84	75-10	12,28
11	20	15,5	72	83	120	3012M	52-11	11,53	62-11	11,97	75-11	12,95
12	20	15,5	77	90	127	3012M	52-12	11,53	62-12	11,97	75-12	12,95
13	20	15,5	82	95	132	3012M	52-13	11,53	62-13	11,97	75-13	13,63
14	20	15,5	89	109	146	3012M	52-14	11,64	62-14	12,49	75-14	13,63

» 3012M-52/-62/-75

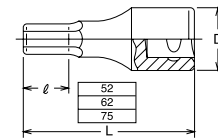

● VASOS CON PUNTA HEXAGONAL

pulg	D	ℓ	⚖			Ref	L52	€	L62	€	L75	€
			52	62	75							
1/8	18	10	35	38	41	3012A	52-1/8	11,04	62-1/8	11,64	75-1/8	12,30
5/32	18	15,5	38	40	43	3012A	52-5/32	11,04	62-5/32	11,64	75-5/32	12,30
3/16	18	15,5	40	43	48	3012A	52-3/16	11,04	62-3/16	11,64	75-3/16	12,30
7/32	18	15,5	42	46	53	3012A	52-7/32	11,04	62-7/32	11,97	75-7/32	12,30
1/4	18	15,5	46	53	67	3012A	52-1/4	10,75	62-1/4	11,97	75-1/4	12,30
9/32	18,5	15,5	50	58	72	3012A	52-9/32	11,64	62-9/32	11,97	75-9/32	12,30
5/16	18,5	15,5	55	63	92	3012A	52-5/16	11,64	62-5/16	11,97	75-5/16	12,30
11/32	20	15,5	66	77	114	3012A	52-11/32	11,64	62-11/32	12,28	75-11/32	12,98
3/8	20	15,5	72	83	120	3012A	52-3/8	11,64	62-3/8	12,28	75-3/8	12,98
7/16	20	15,5	77	90	127	3012A	52-7/16	11,97	62-7/16	12,62	75-7/16	13,62
1/2	20	15,5	82	95	132	3012A	52-1/2	11,97	62-1/2	12,62	75-1/2	14,25
9/16	20	15,5	89	109	146	3012A	52-9/16	12,28	62-9/16	13,16	75-9/16	14,25

» 3012A-52/-62/-75

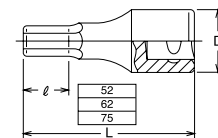

● VASOS CON PUNTA HEXAGONAL

mm	D	⚖				Ref	L62	€	L100	€	L120	€	L160	€
		62	100	120	160									
3	18	45	61	77	87	3011M	62-3	9,79	100-3	10,94	120-3	16,02	160-3	16,35
4	18	46	62	78	88	3011M	62-4	9,79	100-4	10,94	120-4	16,02	160-4	16,35
5	18	48	64	80	89	3011M	62-5	9,79	100-5	10,94	120-5	16,02	160-5	16,37
6	18	49	65	81	91	3011M	62-6	9,79	100-6	10,94	120-6	16,02	160-6	16,37
7	18	50	67	83	93	3011M	62-7	9,79	100-7	10,94	120-7	16,02	160-7	16,52
8	18	51	68	84	95	3011M	62-8	10,29	100-8	11,80	120-8	16,23	160-8	16,52
10	20	66				3011M	62-10	11,03						
12	20	79				3011M	62-12	12,02						

» 3011M-62/-100/-120/-160

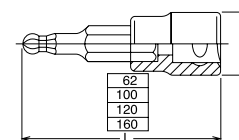
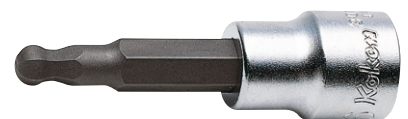

KOKEN IIIIII

● VASOS CON PUNTA XZN

XZN	D	⚖			Ref	L50	€	L100	€	L120	€
		50	100	120							
M4	18	35	57	77	3020	50-4	11,93	100-4	13,22	1204	14,44
M5	18	37	59	79	3020	50-5	11,93	100-5	13,57	1205	14,44
M6	18	39	61	81	3020	50-6	11,93	100-6	13,57	1206	14,44
M8	18	40	62	82	3020	50-8	11,93	100-8	13,57	1208	14,44
M10	20	65	99	119	3020	50-10	12,67	100-10	14,10	12010	14,59
M12	20	69	103	123	3020	50-12	13,21	100-12	15,56	12012	16,21
M14	22	75	145	165	3020	50-14	13,21	100-14	17,93	12014	21,89

» 3020-50/-100/-120

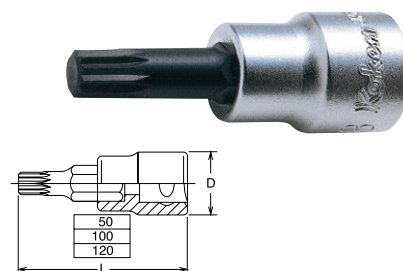

● VASOS CON PUNTA TORX®

TORX®	D	⚖			Ref	L38	€	L50	€	L140	€
		38	50	140							
T8	18	32	36		3025	38-T8	10,69	50-T8	10,53		
T9	18	32	36	75	3025	38-T9	10,69	50-T9	10,53	140-T9	13,22
T10	18	32	36	75	3025	38-T10	10,69	50-T10	10,69	140-T10	13,22
T15	18	33	36	75	3025	38-T15	10,69	50-T15	10,69	140-T15	13,22
T20	18	33	36	75	3025	38-T20	10,69	50-T20	10,69	140-T20	13,22
T25	18	33	37	76	3025	38-T25	10,69	50-T25	10,69	140-T25	13,22
T27	18	33	37	76	3025	38-T27	10,69	50-T27	10,69	140T27	13,22
T30	18	33	38	77	3025	38-T30	10,69	50-T30	10,69	140T30	13,22
T40	18	34	39	78	3025	38-T40	11,89	50-T40	11,21	140T40	14,85
T45	18	37	41	80	3025	38-T45	11,89	50-T45	11,21	140T45	14,85
T50	20	49	55	94	3025	38-T50	11,89	50-T50	11,21	140T50	14,86
T55	20	57	67	106	3025	38-T55	13,20	50-T55	13,21	140T55	16,31

» 3025-38/-50/-140 (T)

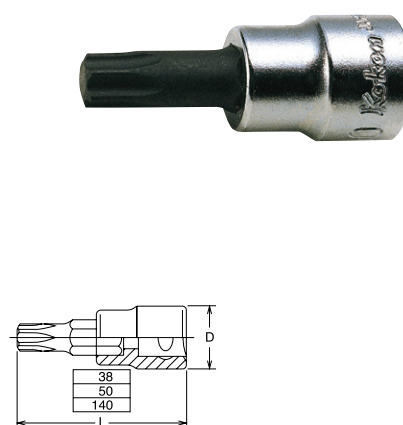

▮▮▮▮▮ ● JUEGO DE VASOS EN REGLETA

Ref	Tipo	▮▮▮▮▮	⚖	▮▮▮▮▮	▮▮▮▮▮	€
RS3025/8-L38	●3025-38 (T)	200	300	8	T10, T15, T20, T25, T27, T30, T40, T45	73,90
RS3025/8-L50	●3025-50 (T)	200	300	8	T10, T15, T20, T25, T27, T30, T40, T45	73,90

»RS3025/8-L38 »RS3025/8-L50



● VASOS CON PUNTA TORX® INVIOLEABLE

TH	D	⚖		Ref L50	€	Ref L160	€
		50	160				
T10H	18	37		3025-50TH10	10,90		
T15H	18	38		3025-50TH15	10,90		
T20H	18	38		3025-50TH20	10,90		
T25H	18	38	83	3025-50TH25	10,90	3025-160TH25	15,86
T27H	18	38	83	3025-50TH27	10,90	3025-160TH27	15,86
T30H	18	39	84	3025-50TH30	10,90	3025-160TH30	15,86
T40H	18	40	85	3025-50TH40	12,16	3025-160TH40	18,79
T45H	18	41	86	3025-50TH45	12,16	3025-160TH45	18,81
T50H	20	61	128	3025-50TH50	12,16	3025-160TH50	18,81
T55H	20	61	128	3025-50TH55	13,79	3025-160TH55	21,06

» 3025-50/-160 (TH)

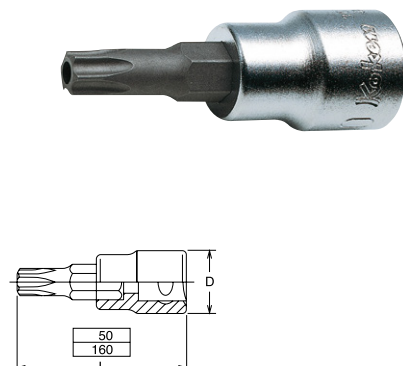

▮▮▮▮▮ ● JUEGO DE VASOS EN REGLETA

Ref	Tipo	▮▮▮▮▮	⚖	▮▮▮▮▮	▮▮▮▮▮	€
RS3025/9-L50TH	● 3025-50TH	200	405	9	T10H, T15H, T20H, T25H, T27H, T30H, T40H, T45H, T50H	92,76

» RS3025/9-L50 (TH)



🌀 JUEGO DE VASOS

» 3247

Ref	Tipo	📏	📏	📏	€
3247	🌀 3025-160TH	405	4	T27H, T30H, T40H, T50H	79,50

Bolsa de plástico.
Para servicio Airbag.



🌀 VASOS CON PUNTA TORX PLUS®

» 3025-50 (IP)

IP	D	L	📏	Ref	€
10IP	18	50	38	3025-5010IP	14,04
15IP	18	50	38	3025-5015IP	14,04
20IP	18	50	38	3025-5020IP	14,04
25IP	18	50	38	3025-5025IP	14,04
27IP	18	50	40	3025-5027IP	14,04
30IP	18	50	40	3025-5030IP	14,04
40IP	18	50	41	3025-5040IP	15,66
45IP	18	50	41	3025-5045IP	15,66
50IP	20	50	61	3025-5050IP	15,66
55IP	20	50	61	3025-5055IP	18,17

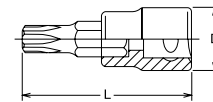

📏 🌀 JUEGO DE VASOS EN REGLETA

» RS3025/8 (IP)

Ref	Tipo	📏	📏	📏	€
RS3025/8IP	🌀 3025-50IP	200	354	8 20IP, 25IP, 27IP, 30IP, 40IP, 45IP, 50IP, 55IP	94,16



📏 🌀 JUEGO DE VASOS EN REGLETA

» RSX025/11 (IP)

Ref	Tipo	📏	📏	📏	pulgadas	€
RSX025/11IP	🌀 2025-28IP	200	354	8	10IP, 15IP, 20IP, 25IP, 27IP,	1/4
	🌀 3025-50IP				30IP, 40IP, 45IP, 50IP,	3/8
	🌀 4025-60IP				55IP, 60IP	1/2
						134,97



$$\frac{1}{4} + \frac{3}{8} + \frac{1}{2}$$

📏 VASOS BIHEXAGONALES LARGOS

» 3110M » 3110A

mm	pulgadas	D	ℓ	L	📏	Ref Métrica	€	Ref Pulgadas	€
6		18	10	28	30	3110M6	9,88		
8	5/16	18	10	28	30	3110M8	9,88	3110A5/16	10,37
10	3/8	18	10	28	33	3110M10	9,88	3110A3/8	10,37
12	1/2	18	10	28	37	3110M12	9,88	3110A1/2	10,37

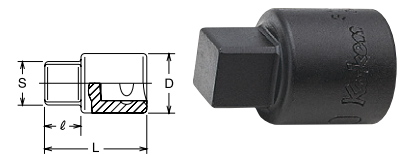

📏 PORTA PUNTA

» 3137

Ref	L	📏	€
3137	30	30	8,53

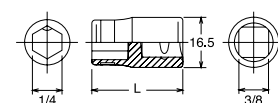

KOKEN IIIIII

○ PORTA PUNTA

» 3138

Ref	L		€
3138	38	55	8,54

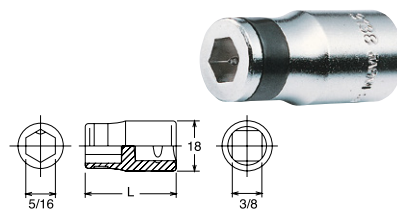

○ PORTA PUNTA EXTRA LARGA PARA 131P-80 Y 131T-80

» 3141

Ref	L		€
3141	48	60	17,67

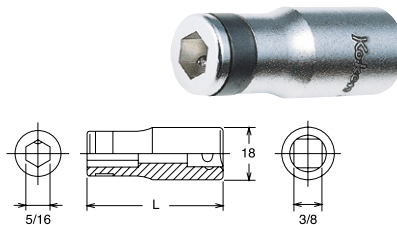

LLAVE DE CARRACA REVERSIBLE CORTA

» 3749S

Ref	Tipo	D	T	Dientes	L		€
3749S	3749	34	24,8	24	110	183	4158

[Pack de repuestos 3749RK]

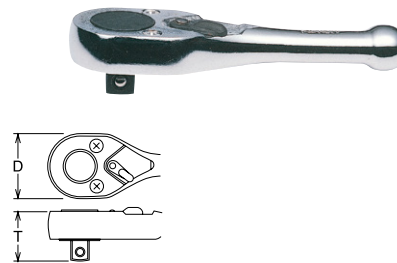

LLAVE DE CARRACA REVERSIBLE CON BOTÓN DE EXTRACCIÓN RÁPIDA*

» 3749SB

Ref	Tipo	D	T	Dientes	L		€
3749SB	3749	34	24,8	24	110	183	53,40

*Los vasos y accesorios se bloquean en posición. Los vasos y alargaderas se extraen de la llave apretando el botón.

[Pack de repuestos 3749RK]

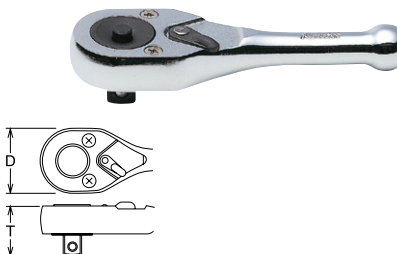

LLAVE DE CARRACA REVERSIBLE

» **3752J**

Ref	Tipo	D	T	Dientes	L	⚖	€
3752J	3752	33	34,3	45	200	310	61,07

[Pack de repuestos **3752RK**]

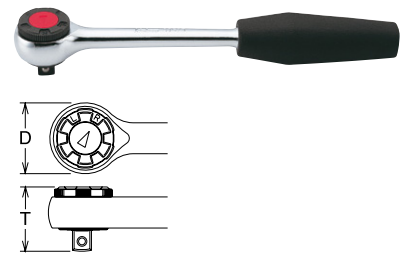

LLAVE DE CARRACA REVERSIBLE

» **3753J**

Ref	Tipo	D	T	Dientes	L	⚖	€
3753J	3753	30,5	26,4	24	200	260	45,59

[Pack de repuestos **3753RK**]

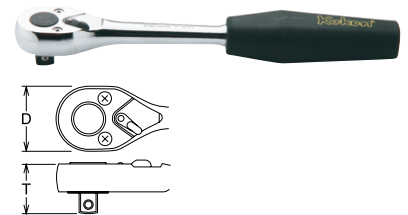

LLAVE DE CARRACA REVERSIBLE

» **3753P**

Ref	Tipo	D	T	Dientes	L	⚖	€
3753P	3753	30,5	26,4	24	200	286	46,90

[Pack de repuestos **3753RK**]

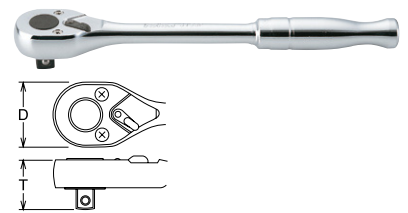

LLAVE DE CARRACA REVERSIBLE CON BOTÓN DE EXTRACCIÓN RÁPIDA*

» **3753JB**

Ref	Tipo	D	T	Dientes	L	⚖	€
3753JB	3753	30,5	26,4	24	200	260	55,27

*Los vasos y accesorios se bloquean en posición. Los vasos y alargaderas se extraen de la llave apretando el botón.

[Pack de repuestos **3753BRK**]

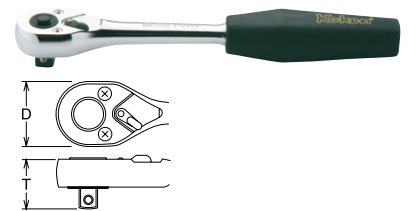

LLAVE DE CARRACA REVERSIBLE CON BOTÓN DE EXTRACCIÓN RÁPIDA*

» **3753PB**

Ref	Tipo	D	T	Dientes	L	⚖	€
3753PB	3753	30,5	26,4	24	200	286	57,29

*Los vasos y accesorios se bloquean en posición. Los vasos y alargaderas se extraen de la llave apretando el botón.

[Pack de repuestos **3753BRK**]

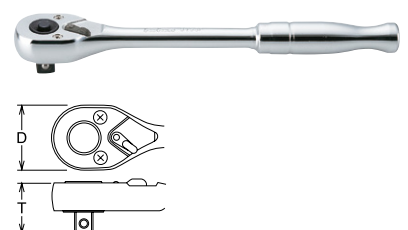

KOKEN IIIIII

LLAVE DE CARRACA REVERSIBLE

Ref	Tipo	D	T	Dientes	L	⚖	€
2774JS-3/8	2774	25	21,9	24	120	113	67,27

[Pack de repuestos 2749RK-3/8]



» 2774JS-3/8

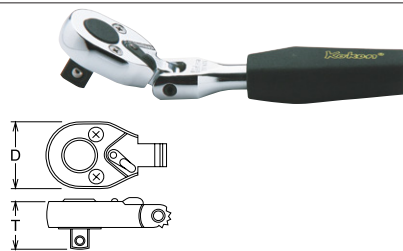

LLAVE DE CARRACA ARTICULADA REVERSIBLE

Ref	Tipo	D	T	Dientes	L	⚖	€
3774P	3774	30,5	26,4	24	265	378	65,15

[Pack de repuestos 3753RK]



» 3774P

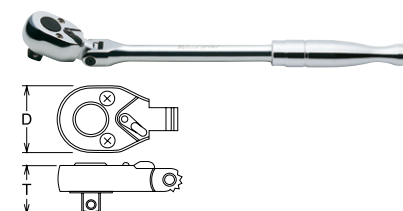

ADAPTADOR DE CARRACA

Ref	L	⚖	€
3755	55	146	45,85

[Pack de repuestos 3755RK]



» 3755



DISCO DE GIRO RÁPIDO

Ref	L	⚖	€
3756	25,5	47	15,91

» 3756

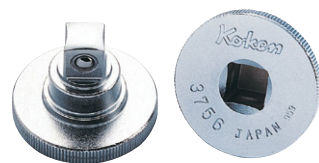

ALARGADERAS

Ref	L	⚖	€
3760-32	32	27	8,27
3760-50	50	47	8,27
3760-75	75	68	8,27
3760-125	125	106	9,14
3760-150	150	125	11,94
3760-250	250	196	13,73
3760-300	300	291	15,90
3760-400	400	365	21,68
3760-500	500	490	34,81
3760-600	600	538	34,81
3760-900	900	805	60,34
3760-1000	1000	968	80,94

» 3760

-32/-50/-75/-125/-150/-250/
-300/-400/-600/-900/-1000



Patentado

LLAVES DE ALARGADERAS EN CAJA DE PLÁSTICO

Ref	Tipo	⚖	📏	📏	€
PK3760/6	3760	670	6	32, 50, 75, 125, 150, 250	89,04

»PK3760/6



ALARGADERA FLEXIBLE

» **3762-300**

Ref	L		€
3762-300	300	178	33,17



ALARGADERAS ARTICULADAS-FIJAS*

» **3763-32/-50/-75/-125/-150/-250**

Ref	L		€
3763-32	32	26	9,14
3763-50	50	42	10,83
3763-75	75	57	11,93
3763-125	125	80	13,26
3763-150	150	98	16,50
3763-250	250	144	20,19
3763-300	300	170	22,60



Patentado

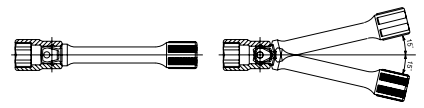

*Dos formas de utilización: Una como alargadera flexible para poder trabajar con un ángulo de 15° y otra para utilizarse como alargadera normal. Esta aplicación está patentada.



ALARGADERAS ARTICULADAS-FIJAS EN CAJA DE PLÁSTICO

» **PK3763/6**

Ref	Tipo				€
PK3763/6	 3763	560	6	32, 50, 75, 125, 150, 250	82,32



MANGO ARTICULADO

» **3768J-250**

Ref	L		€
3768J-250	250	248	33,59



Patentado

[Pack de repuestos 3768RK]

MANGO TIPO DESTORNILLADOR

» **3769N-160/-230**

Ref	L		€
3769N-160	160	96	15,31
3769N-230	230	126	16,74



Patentado

MANGO TIPO DESTORNILLADOR

» **3769H**

Ref	L		€
3769H	170	210	42,01

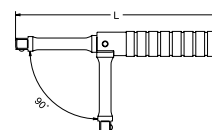

ARTICULACIÓN UNIVERSAL

» 3770

Ref	L	⚖	€
3770	50	66	18,75

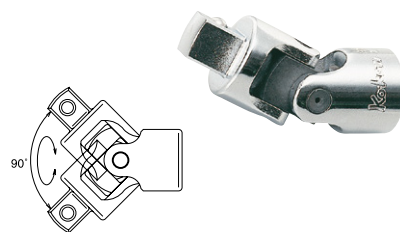

MANIVELA RÁPIDA

» 3780

Ref	L	⚖	€
3780	400	432	24,02



MANGO CORREDIZO

» 3785

Ref	L	⚖	€
3785	200	157	13,44



ADAPTADOR*

» 3322A

Ref	L	⚖	€
3322A	24	18	8,26

*La adaptación de mayor a menor de un cuadro conductor puede conducir a un par excesivo que puede causar rotura.

[Garantizado 86 Nm]

□3/8" x ▽1/4"



ADAPTADOR

» 3344A

Ref	L	⚖	€
3344A	30	35	8,43

[Garantizado 86 Nm]

□3/8" x ▽1/2"



JUEGO DE VASOS

» ESH3001

Ref				€
ESH3001	415 x 120 x 50	17	2.200	168,37

Vasos

3410M ○ 8, 9, 10, 11, 12, 13, 14, 15, 16, 17, 18, 19

Accesorios

- 3753J
- 3763-125
- 3760-250
- 3770
- 3785



JUEGO DE VASOS

» ETH3001

Ref				€
ETH3001	392 x 90 x 50	22	1.820	182,98

Vasos

3425 ○ E4, E5, E6, E7, E8
 4425 ○ E10, E11, E12, E14, E16, E18
 3025.50 ● T10, T15, T20, T25, T27
 4025.60 ● T30, T40, T45, T50, T55

Accesorios

4433A-35



JUEGO DE VASOS

» 3206AM

Ref				€
3206AM	445 X 190 X 50	27	3.500	266,28

Vasos

3405M ○ 7, 8, 10, 11, 12, 13, 14, 15, 16, 17, 19, 22
 3405A ○ 3/8, 7/16, 1/2, 9/16, 5/8, 11/16, 3/4, 13/16, 7/8
 3300C ○ 20,8

Accesorios

- 3753J
- 3760-125
- 3760-250
- 3768J-250
- 3770



JUEGO DE VASOS

» 3210M » 3210A

Ref				€
○ 3210M-00	360 x 145 x 50	22	2.900	225,03
○ 3210M-05	360 x 145 x 50	22	2.900	225,03
○ 3210M-10	360 x 145 x 50	22	2.900	227,48
○ 3210A-00	360 x 145 x 50	18	2.760	202,85

Vasos 3210M-00

3400M ○ 6, 7, 8, 9, 10, 11, 12, 13, 14, 15, 16, 17, 18, 19, 21, 22

Vasos 3210M-05

3405M ○ 6, 7, 8, 9, 10, 11, 12, 13, 14, 15, 16, 17, 18, 19, 21, 22

Vasos 3210M-10

3410M ○ 6, 7, 8, 9, 10, 11, 12, 13, 14, 15, 16, 17, 18, 19, 21, 22

Vasos 3210A-00

3400A ○ 1/4, 5/16, 11/32, 3/8, 7/16, 1/2, 9/16, 5/8, 11/16, 3/4, 13/16, 7/8

Accesorios

- 3753J
- 3760-125
- 3760-250
- 3768J-250
- 3770
- 3785



KOKEN IIIIII

□ 3/8" LLAVES DE VASO

🏠 ○ ○ ○ JUEGO DE VASOS

Ref	🏠	🏠	⚖️	€
○ 3217M-00	163 x 52 x 33	14	850	74,58
○ 3217M-05	163 x 52 x 33	14	850	74,58
○ 3217M-10	163 x 52 x 33	14	850	77,80

Vasos 3217M-00

3400M ○ 9, 10, 11, 12, 13, 14, 15., 16, 17, 18, 19, 20, 21, 22

Vasos 3217M-05

3405M ○ 9, 10, 11, 12, 13, 14, 15., 16, 17, 18, 19, 20, 21, 22

Vasos 3217M-10

3410M ○ 9, 10, 11, 12, 13, 14, 15., 16, 17, 18, 19, 20, 21, 22

» 3217M



🏠 ○ ○ JUEGO DE VASOS

Ref	🏠	🏠	⚖️	€
○ 3250M-00	415 x 120 x 50	17	2.200	166,77
○ 3250M-05	415 x 120 x 50	17	2.200	166,77

Vasos 3250M-00

3400M ○ 7, 8, 9, 10, 11, 12, 13, 14, 15, 16, 17, 18, 19

Vasos 3250M-05

3405M ○ 7, 8, 9, 10, 11, 12, 13, 14, 15, 16, 17, 18, 19

Accesorios

3753J	
3760-125	
3760-250	
3770	
3785	

» 3250M



🏠 JUEGO DE VASOS

Ref	🏠	🏠	⚖️	€
3277	370 x 150 x 50	29	3.240	313,02

Vasos

3400M ○ 8, 9, 10, 11, 12
 3405M ○ 13, 14, 15, 16, 17, 18, 19, 21
 3300M ○ 8, 9, 10, 11, 12
 3305M ○ 13, 14, 15, 16, 17, 18, 19, 21

Accesorios

3753J	
3760-125	
3768J-250	

» 3277



🏠 JUEGO DE VASOS CON PUNTA

Ref	🏠	🏠	⚖️	€
3278	310 x 150 x 50	20	3.370	238,51

Vasos

3000 ⊕ 2, 3
 3010M.62 ● 5, 6, 7, 8, 10
 3020.50 ● M4, M5, M6, M8
 3025.50 ● T10, T15, T20, T25, T27, T30, T40

Accesorios

3753J	
3760-125	
3768J-250	

» 3278





○ VASOS HEXAGONALES HANDY-ENDY®

mm	D1	D2	ℓ	L	⚖	Ref	€
8	13,2	22	8	36	44	4401M8	5,21
9	13,8	22	8,5	37	44	4401M9	5,21
10	15,3	22	9	37	45	4401M10	5,21
11	16,5	22	9,5	37	46	4401M11	5,21
12	17,8	22	10	37	47	4401M12	5,21
13	19	22	10,5	37	63	4401M13	5,21
14	20,3	22	11	37	56	4401M14	5,56
15	21,5	22	11,5	37	52	4401M15	5,56
16	22,8	22	12	37	62	4401M16	5,56
17	24	22	12,5	37	69	4401M17	5,56
18	25	23	13	37	74	4401M18	5,56
19	26,5	24,5	14	38	89	4401M19	5,56
20	27,8	26	15	38	92	4401M20	6,44
21	29	27	15,5	38	102	4401M21	6,44
22	30	28	16	40	113	4401M22	6,44
23	31,5	29	16,5	40	128	4401M23	6,92
24	32,8	30	17	42	140	4401M24	6,92
25	34	31	18	42	164	4401M25	8,62
26	35	32	19	42	165	4401M26	8,62
27	36,5	33	19,5	43	196	4401M27	8,62
28	37,8	34	20	43	198	4401M28	10,13
29	39	35	20,5	43	190	4401M29	10,13
30	40	36	22	46	222	4401M30	11,04
31	41,5	37	22,5	46	257	4401M31	11,21
32	42,8	38	23	46	250	4401M32	11,21
33	44,2	39	24	47	275	4400M33	16,43
34	45,2	40	24	47	315	4400M34	16,74
35	46,2	40	24	47	317	4400M35	17,85
36	47,2	41	24	47	336	4400M36	18,12
37	48,3	42	24	47	360	4400M37	22,64
38	49,2	43	24	47	380	4400M38	23,66
41	53,1	45	29	57	471	4400M41	41,43
46	59,1	48	32	60	567	4400M46	46,79

» 4401M / 4400M

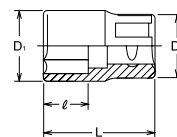

○ VASOS BIHEXAGONALES HANDY-ENDY®

mm	D1	D2	ℓ	L	⚖	Ref	€
8	13,2	22	8	36	44	4406M8	5,21
9	13,8	22	8,5	37	44	4406M9	5,21
10	15,3	22	9	37	45	4406M10	5,21
11	16,5	22	9,5	37	46	4406M11	5,21
12	17,8	22	10	37	47	4406M12	5,21
13	19	22	10,5	37	63	4406M13	5,21
14	20,3	22	11	37	56	4406M14	5,56
15	21,5	22	11,5	37	52	4406M15	5,56
16	22,8	22	12	37	62	4406M16	5,56
17	24	22	12,5	37	69	4406M17	5,56
18	25	23	13	37	74	4406M18	5,56
19	26,5	24,5	14	38	89	4406M19	5,56
20	27,8	26	15	38	92	4406M20	6,44
21	29	27	15,5	38	102	4406M21	6,44
22	30	28	16	40	113	4406M22	6,44
23	31,5	29	16,5	40	128	4406M23	6,92
24	32,8	30	17	42	140	4406M24	6,92
25	34	31	18	42	164	4406M25	8,62
26	35	32	19	42	165	4406M26	8,62
27	36,5	33	19,5	43	196	4406M27	8,62
28	37,8	34	20	43	198	4406M28	10,13
29	39	35	20,5	43	190	4406M29	10,13
30	40	36	22	46	222	4406M30	11,04
31	41,5	37	22,5	46	257	4406M31	11,21
32	42,8	38	23	46	250	4406M32	11,21
33	44,2	39	24	47	275	4405M33	16,43
34	45,2	40	24	47	315	4405M34	16,74
35	46,2	40	24	47	317	4405M35	17,35
36	47,2	41	24	47	336	4405M36	18,12
37	48,3	42	24	47	360	4405M37	23,66
38	49,2	43	24	47	380	4405M38	23,66
41	53,1	45	29	57	471	4405M41	41,43
46	59,1	48	32	60	567	4405M46	41,43

» 4406M / 4405M

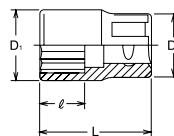

JUEGO DE VASOS EN REGLETA

Ref	Tipo					€
RS4401M/10	○ 4401M	300	720	10	10, 11, 12, 13, 14, 15, 16, 17, 18, 19	50,15

» RS4401M/10



JUEGO DE VASOS EN REGLETA

Ref	Tipo					€
RS4406M/10	○ 4406M	300	720	10	10, 11, 12, 13, 14, 15, 16, 17, 18, 19	50,15

» RS4406M/10



VASOS HEXAGONALES

pulgadas	D1	D2	ℓ	L		Ref	€
1/4	10,7	21	6	36	41	4400A1/4	5,38
5/16	13,2	21	8	36	44	4400A5/16	5,38
3/8	14,6	21	9	37	45	4400A3/8	5,38
7/16	16,5	21	9,5	37	46	4400A7/16	5,38
1/2	19	22	10,5	37	53	4400A1/2	5,38
9/16	20,3	22	11	37	56	4400A9/16	5,84
19/32	21,5	22	11,5	37	52	4400A19/32	5,84
5/8	22,8	22	12	37	62	4400A5/8	5,84
21/32	24	23	12,5	37	69	4400A21/32	5,84
11/16	25	24	13	37	74	4400A11/16	6,00
3/4	26,5	25	14	38	89	4400A3/4	6,00
25/32	27,8	26	15	38	92	4400A25/32	6,74
13/16	29	27	15,5	38	102	4400A13/16	6,74
7/8	30	28	16	40	113	4400A7/8	6,74
15/16	32,8	30	17	42	140	4400A15/16	6,92
31/32	34	31	18	42	165	4400A31/32	9,09
1	35	32	19	42	165	4400A1	9,09
1-1/16	36,5	33	19,5	43	180	4400A 1-1/16	9,09
1-1/8	39	35	20,5	43	210	4400A 1-1/8	10,62
1-3/16	40	36	22	46	222	4400A 1-3/16	11,65
1-1/4	42,8	38	23	46	250	4400A 1-1/4	12,48
1-5/16	44,2	39	24	47	275	4400A 1-5/16	16,74
1-3/8	46,2	40	24	47	317	4400A 1-3/8	18,12
1-7/16	47,2	41	24	47	336	4400A 1-7/16	24,83
1-1/2	49,2	43	24	47	380	4400A 1-1/2	24,85

» 4400A

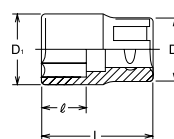

JUEGO DE VASOS EN REGLETA

Ref	Tipo					€
RS4400A/10	○ 4400A	300	809	10	3/8, 7/16, 1/2, 9/16, 5/8, 11/16, 3/4, 13/16, 7/8, 15/16	55,95
RS4405A/10	○ 4405A	300	809	10	3/8, 7/16, 1/2, 9/16, 5/8, 11/16, 3/4, 13/16, 7/8, 15/16	55,95

» RS4400A/10 » RS4405A/10



○ VASOS HEXAGONALES

pulgadas	D1	D2	ℓ	L	⚖	Ref	€
1/4	10,7	21	6	36	41	4405A1/4	5,40
5/16	13,2	21	8	36	44	4405A5/16	5,40
3/8	14,6	21	9	37	45	4405A3/8	5,40
7/16	16,5	21	9,5	37	46	4405A7/16	5,40
1/2	19	22	10,5	37	53	4405A1/2	5,40
9/16	20,3	22	11	37	56	4405A9/16	5,84
19/32	21,5	22	11,5	37	52	4405A19/32	5,84
5/8	22,8	22	12	37	62	4405A5/8	5,84
21/32	24	23	12,5	37	69	4405A21/32	5,84
11/16	25	24	13	37	74	4405A11/16	6,00
3/4	26,5	25	14	38	89	4405A3/4	6,00
25/32	27,8	26	15	38	92	4405A25/32	6,74
13/16	29	27	15,5	38	102	4405A13/16	6,74
7/8	30	28	16	40	113	4405A7/8	6,74
15/16	32,8	30	17	42	140	4405A15/16	6,93
31/32	34	31	18	42	165	4405A31/32	9,09
1	35	32	19	42	165	4405A1	9,09
1-1/16	36,5	33	19,5	43	180	4405A 1-1/16	9,09
1-1/8	39	35	20,5	43	210	4405A 1-1/8	10,60
1-3/16	40	36	22	46	222	4405A 1-3/16	11,65
1-1/4	42,8	38	23	46	250	4405A 1-1/4	11,65
1-5/16	44,2	39	24	47	275	4405A 1-5/16	16,74
1-3/8	46,2	40	24	47	317	4405A 1-3/8	18,12
1-7/16	47,2	41	24	47	336	4405A 1-7/16	24,85
1-1/2	49,2	43	24	47	380	4405A 1-1/2	24,85

» 4405A

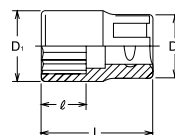

○ VASOS SURFACE DRIVE (DE CONTACTO CURVO)

mm	D1	D2	ℓ	L	⚖	Ref	€
8	13,2	21	8	36	44	4410M8	5,38
9	13,8	21	8,5	37	44	4410M9	5,38
10	15,3	21	9	37	45	4410M10	5,38
11	16,5	21	9,5	37	46	4410M11	5,38
12	17,8	21	10	37	47	4410M12	5,38
13	19	22	10,5	37	53	4410M13	5,38
14	20,3	22	11	37	56	4410M14	5,84
15	21,5	22	11,5	37	52	4410M15	5,84
16	22,8	22	12	37	62	4410M16	5,84
17	24	23	12,5	37	69	4410M17	5,84
18	25	24	13	37	74	4410M18	5,84
19	26,5	25	14	38	89	4410M19	5,84
20	27,8	26	15	38	92	4410M20	6,61
21	29	27	15,5	38	102	4410M21	6,61
22	30	28	16	40	113	4410M22	6,61
23	31,5	29	16,5	40	128	4410M23	6,74
24	32,8	30	17	42	140	4410M24	6,74
25	34	31	18	42	164	4410M25	9,09
26	35	32	19	42	165	4410M26	9,09
27	36,5	33	19,5	43	196	4410M27	9,09
28	37,8	34	20	43	198	4410M28	10,43
29	39	35	20,5	43	190	4410M29	10,43
30	40	36	22	46	222	4410M30	11,37
31	41,5	37	22,5	46	257	4410M31	11,53
32	42,8	38	23	46	250	4410M32	11,53
34	45,2	40	24	47	314	4410M34	19,28

» 4410M

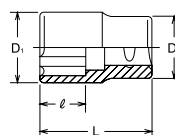

○ VASOS WITWORTH BIHEXAGONALES

» 4405W

pulgadas	D1	D2	ℓ	L	⚖	Ref	€
3/16	16,5	21	9,5	37	46	4405W3/16	6,70
1/4	19	22	10,5	37	54	4405W1/4	6,70
5/16	21,5	22	11,5	37	54	4405W5/16	7,20
3/8	25	24	13	37	73	4405W3/8	7,20
7/16	29	27	15,5	38	87	4405W7/16	8,19
1/2	31,5	29	16,5	40	133	4405W1/2	8,53
9/16	35	32	19	42	165	4405W9/16	9,74
5/8	37,8	34	20	43	191	4405W5/8	12,89
11/16	40	36	22	46	222	4405W11/16	14,85
3/4	44,2	39	24	47	280	4405W3/4	18,24

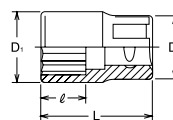

⊕ VASOS TORX®

» 4425

TORX®	D1	D2	ℓ	L	⚖	Ref	€
E8	10,7	21	7	36	41	4425E8	6,73
E10	13,2	21	8,2	36	44	4425E10	6,73
E11	13,8	21	8,7	37	45	4425E11	6,73
E12	14,6	21	9,3	37	47	4425E12	6,73
E14	16,5	21	10,6	37	48	4425E14	6,73
E16	19	22	11,8	37	57	4425E16	6,73
E18	20,3	22	13	37	57	4425E18	6,73
E20	22,8	22	14,4	37	63	4425E20	7,60
E22	25	24	15,5	37	78	4425E22	13,98
E24	26,5	25	17	40	95	4425E24	10,98

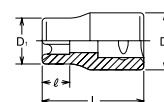

▮ JUEGO DE VASOS EN REGLETA

» RS4425/7

Ref	Tipo	▮	⚖	▮	▮	€
RS4425/7	⊕ 4425	200	428	7	E10, E12, E14, E16, E18, E20, E24	58,67



⊕ VASOS LHS

» 4400LH

LHS	D1	D2	ℓ	L	⚖	Ref	€
6S	13,2	21	5,6	36	44	4400LH6S	9,79
8S	16,5	21	6,8	37	46	4400LH8S	9,79
10S	19	22	8	37	53	4400LH10S	9,79
12S	22,8	22	9,2	37	62	4400LH12S	10,00
14S	25	24	10,4	37	74	4400LH14S	10,83
16S	29	27	11,6	38	102	4400LH16S	12,32

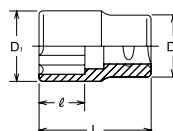

○ VASOS SUJETA-TUERCAS NUT GRIP®

» 4450M

mm	D1	D2	ℓ	L	⚖	Ref	€
10	15,3	21	6	36	44	4450M10	9,07
11	16,5	21	6,5	36	46	4450M11	9,07
12	17,8	21	7	36	46	4450M12	9,07
13	19	22	8	36	52	4450M13	9,36
14	20,3	22	8,5	36	54	4450M14	9,36
15	21,5	22	9	36	52	4450M15	9,36
16	22,8	22	9	36	60	4450M16	9,36
17	24	23	9,5	36	68	4450M17	9,36
18	25	24	10,5	36	77	4450M18	9,52
19	26,5	25	11,5	36	85	4450M19	9,52
21	29	27	12	37	110	4450M21	9,83
22	30	28	12,5	37	105	4450M22	10,18
24	32,8	30	14,5	39	130	4450M24	11,12
27	36,5	33	16,5	40	139	4450M27	12,85

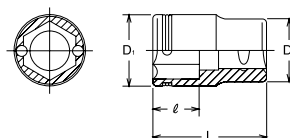

○ VASOS OCTOGONALES

» 4109M

mm	D1	D2	ℓ	L	⚖	Ref	€
14	26,8	26	11	38	110	4109M14	9,73
17	30	28	12,5	40	140	4109M17	9,73
19	31,5	29	14	40	150	4109M19	11,41
21,5	35	32	16	40	170	4109M21,5	11,41
23	37	34	16,5	43	180	4109M23	14,32

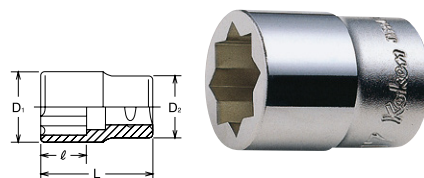

○ VASOS HEXAGONALES LARGOS

» 4300M » 4300A

mm	pulgadas	D1	D2	ℓ	L	⚖	Ref Métrica	€	Ref Pulgadas	€
8	5/16	13,2	21	9	77	76	4300M8	12,43		
9		13,8	21	10	77	82	4300M9	12,43		
10	3/8	14,6	21	10	77	82			4300A3/8	13,20
11	7/16	16,5	21	11	77	86	4300M11	12,43	4300A7/16	13,20
12		17,8	21	13	77	92	4300M12	12,43		
13	1/2	19	21,8	14	77	106	4300M13	12,43	4300A1/2	13,20
14	9/16	20,3	21,8	15	77	115	4300M14	12,43	4300A9/16	13,20
15	19/32	21,5	21,8	16	77	123	4300M15	12,43	4300A19/32	13,20
16	5/8	22,8	22	17	77	141	4300M16	12,43	4300A5/8	13,20
17	21/32	24	23	18	77	139	4300M17	12,43	4300A21/32	13,20
18	11/16	25	24	19	77	149	4300M18	13,66	4300A11/16	14,42
19	3/4	26,5	25	20	77	165	4300M19	13,66	4300A3/4	14,42
20	25/32	27,8	26	21	77	183	4300M20	13,66	4300A25/32	14,42
21	13/16	29	27	23	77	190	4300M21	16,12	4300A13/16	16,87
22	7/8	30	28	27	77	200	4300M22	16,12	4300A7/8	16,87
23		31,5	29	27	77	233	4300M23	16,12		
24	15/16	32,8	30	27	77	249	4300M24	18,12	4300A15/16	19,20
25	31/32	34	31	27	77	270	4300M25	18,12	4300A31/32	19,20
26	1	35	32	27	77	279	4300M26	18,12	4300A1	19,20
27	1-1/16	36,5	33	28	77	303	4300M27	18,12	4300A1-1/16	19,20
28	1-1/8	37,8	34	28	77	331	4300M28	20,87	4300A 1-1/8	23,66
29		39	35	34	77	357	4300M29	22,58		
30	1-3/16	40	36	34	77	342	4300M30	22,58	4300A 1-3/16	23,80
31		41,5	37	34	77	384	4300M31	22,58		
32	1-1/4	42,8	38	34	77	405	4300M32	22,58	4300A 1-1/4	23,80
33	1-5/16	44,2	39	35	77	420	4300M33	40,58	4300A 1-5/16	
34		45,2	40	35	77	442	4300M34	40,58		
35		46,2	40	35	77	458	4300M35	40,58		
36	1-3/8	46,2	40	35	77	422			4300A 1-3/8	37,41
37	1-7/16	47,2	41	35	77	484	4300M36	45,47	4300A 1-7/16	45,88
38		48,2	42	38	77	475	4300M37	45,47		
39		49	44	38	77	490	4300M38	45,47		
40	1-1/2	49	44	38	77	523			4300A 1-1/2	47,29
41	1-13/16	59	48	38	77	791			4300A 1-13/16	60,41

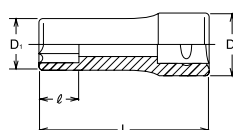

○ VASOS HEXAGONALES LARGOS

» 4305M » 4305A

mm	pulgadas	D1	D2	ℓ	L	⚖	Ref Métrica	€	Ref Pulgadas	€
8	5/16	13,2	21	9	77	76	4305M8	12,44		
9		13,8	21	10	77	82	4305M9	12,44		
	3/8	14,6	21	10	77	82			4305A3/8	13,21
10		15,3	21	11	77	82	4305M10	12,44		
11	7/16	16,5	21	12	77	86	4305M11	12,44	4305A7/16	13,21
12		17,8	21	13	77	92	4305M12	12,44		
13	1/2	19	21,8	14	77	106	4305M13	12,44	4305A1/2	13,21
14	9/16	20,3	21,8	15	77	115	4305M14	12,44	4305A9/16	13,21
15	19/32	21,5	21,8	16	77	123	4305M15	12,44	4305A19/32	
16	5/8	22,8	22	17	77	141	4305M16	12,44	4305A5/8	13,21
17	21/32	24	23	18	77	139	4305M17	12,44	4305A21/32	
18	11/16	25	24	19	77	149	4305M18	13,68	4305A11/16	14,41
19	3/4	26,5	25	20	77	165	4305M19	13,68	4305A3/4	14,41
20	25/32	27,8	26	21	77	183	4305M20	13,68	4305A25/32	
21	13/16	29	27	23	77	190	4305M21	16,14	4305A13/16	14,87
22	7/8	30	28	27	77	200	4305M22	16,14	4305A7/8	16,87
23		31,5	29	27	77	233	4305M23	16,14		
24	15/16	32,8	30	27	77	249	4305M24	18,12	4305A15/16	19,20
25	31/32	34	31	27	77	270	4305M25	18,12	4305A31/32	19,20
26	1	35	32	27	77	279	4305M26	18,12	4305A1	19,20
27	1-1/16	36,5	33	28	77	303	4305M27	18,12	4305A1-1/16	19,21
28	1-1/8	37,8	34	28	77	331	4305M28	20,87	4305A 1-1/8	23,66
29		39	35	34	77	357	4305M29	22,58		
30	1-3/16	40	36	34	77	342	4305M30	22,58	4305A 1-3/16	23,80
31		41,5	37	34	77	384	4305M31	22,58		
32	1-1/4	42,8	38	34	77	405	4300M32	22,58	4305A 1-1/4	23,80
33	1-5/16	44,2	39	35	77	420	4305M33	39,87	4305A 1-5/16	
34		45,2	40	35	77	442	4305M34	42,58		
35		46,2	40	35	77	458	4305M35	42,58		
	1-3/8	46,2	40	35	77	422			4305A 1-3/8	37,41
36	1-7/16	47,2	41	35	77	484	4305M36	45,47	4305A 1-7/16	45,88
37		48,2	42	38	77	475	4305M37	45,47		
38		49	44	38	77	490	4305M38	45,47		
	1-1/2	49	44	38	77	523			4305A 1-1/2	47,29
	1-13/16	59	48	38	77	791			4305A 1-13/16	60,40

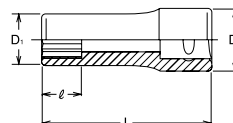

KOKEN IIIIII

▤ ○ ○ JUEGO DE VASOS EN REGLETA

» RS4300M/10 » RS4305M/10

Ref	Tipo	▤	⚖	▤	▤	€
RS4300M/10	○ 4300M	300	1.415	10	10, 11, 12, 13, 14, 15, 16, 17, 18, 19, 21, 22	116,74
RS4305M/10	○ 4300M	300	1.415	10	10, 11, 12, 13, 14, 15, 16, 17, 18, 19, 21, 22	116,74



▤ ○ ○ JUEGO DE VASOS EN REGLETA

» RS4300M/12

Ref	Tipo	▤	⚖	▤	▤	€
RS4300M/12	○ 4300M	300	1.825	12	10, 12, 13, 14, 15, 16, 17, 18, 19, 20, 21, 22	141,59



▤ ○ ○ JUEGO DE VASOS EN REGLETA

» RS4300A/10 » RS4305A/10

Ref	Tipo	▤	⚖	▤	▤	€
RS4300A/10	○ 4400A	300	1.600	10	3/8, 7/16, 1/2, 9/16, 5/8, 11/16, 3/4, 13/16, 7/8, 15/16	129,26
RS4305A/10	○ 4405A	300	1.600	10	3/8, 7/16, 1/2, 9/16, 5/8, 11/16, 3/4, 13/16, 7/8, 15/16	129,26



○ VASOS SURFACE DRIVE (DE CONTACTO CURVO)

mm	D1	D2	ℓ	L	⚖	Ref	€
8	13,2	21	9	77	79	4310M8	13,60
9	13,8	21	10	77	82	4310M9	13,60
10	15,3	21	11	77	82	4310M10	13,60
11	16,5	21	12	77	86	4310M11	13,60
12	17,8	21	13	77	92	4310M12	13,60
13	19	21,8	14	77	106	4310M13	13,60
14	20,3	21,8	15	77	115	4310M14	13,60
15	21,5	21,8	16	77	123	4310M15	13,60
16	22,8	22	17	77	141	4310M16	13,60
17	24	23	18	77	139	4310M17	13,60
18	25	24	19	77	149	4310M18	15,05
19	26,5	25	20	77	165	4310M19	15,05
20	27,8	26	21	77	183	4310M20	15,05
21	29	27	23	77	190	4310M21	16,74
22	30	28	27	77	200	4310M22	16,74
23	31,5	29	27	77	233	4310M23	17,50
24	32,8	30	27	77	249	4310M24	19,98
25	34	31	27	77	270	4310M25	19,98
26	35	32	27	77	279	4310M26	19,98
27	36,5	33	28	77	303	4310M27	19,98
28	37,8	34	28	77	334	4310M28	22,90
29	39	35	28	77	357	4310M29	24,70
30	40	36	34	77	342	4310M30	24,70
31	41,5	37	34	77	384	4310M31	24,70
32	42,8	38	34	77	405	4310M32	24,70
34	45,2	40	35	77	442	4310M34	42,31

» 4310M

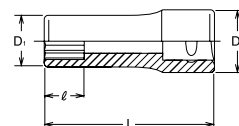

○ VASOS TORX® LARGOS

TORX®	D1	D2	ℓ	L	⚖	Ref	€
E8	10,7	21	7	77	68	4325E8	16,19
E10	13,2	21	8,2	77	99	4325E10	16,19
E11	13,8	21	8,7	77	84	4325E11	16,19
E12	14,6	21	9,3	77	99	4325E12	16,19
E14	16,5	21	10,6	77	103	4325E14	16,19
E16	19	21,8	11,8	77	107	4325E16	16,19
E18	20,3	21,8	13	77	118	4325E18	16,19
E20	22,8	22	14,4	77	141	4325E20	18,66
E22	25	24	15,5	77	188	4325E22	20,46
E24	26,5	25	17	77	215	4325E24	20,46

» 4325

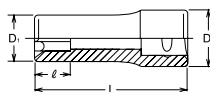

○ VASOS PARA RUEDAS LARGOS

mm	D1	D2	ℓ	L	⚖	Ref	€
17	23	22	32	110	155	4300M-11017	42,66
19	25,8	22	32	110	170	4300M-11019	42,66
21	26,8	22	32	110	165	4300M-11021	42,66

» 4300M (L110)

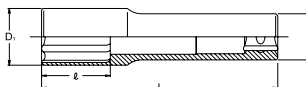

○ VASOS HEXAGONALES EXTRA LARGOS

mm	D1	D2	ℓ	L	⚖	Ref	€
8	13,2	21	9	120	120	4300M-1208	42,75
10	15,3	21	11	120	138	4300M-12010	42,75
12	17,8	21	13	120	157	4300M-12012	42,75
14	20,3	21,8	15	120	193	4300M-12014	42,75
16	22,8	22	17	120	210	4300M-12016	42,75

» 4300M (L120)

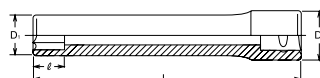

VASOS TORX® EXTRA LARGOS

TORX®	D1	D2	ℓ	L	⚖️	Ref	€
E8	10,7	21	7	140	110	4325-140E8	55,19
E10	13,2	21	8,2	140	140	4325-140E10	55,19
E12	14,6	21	9,3	140	160	4325-140E12	55,19
E14	16,5	21	10,6	140	180	4325-140E124	55,19

» 4325 (L140)

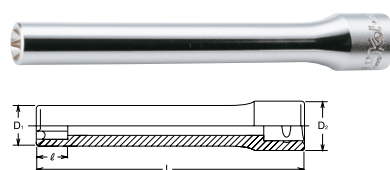

VASOS CON ALARGADERA

mm	D1	D2	ℓ	⚖️		Ref L125	€	Ref L250	€
				125	250				
13	18,7	24	13	213	412	4117M-12513	25,15	4117M-25013	29,14
14	20,2	24	14	227	423	4117M-12514	25,15	4117M-25014	29,14
17	24	24	17	274	469	4117M-12517	25,15	4117M-25017	29,14
19	26,9	24	19	279	484	4117M-12519	27,75	4117M-25019	31,94
21	28,5	24	21	291	496	4117M-12521	29,94	4117M-25021	33,79
22	30	24	22	323	516	4117M-12522	29,94	4117M-25022	33,79
24	32	24	24	361	560	4117M-12524	31,01	4117M-25024	35,41
27	36,5	24	27	439	641	4117M-12527	33,95	4117M-25027	37,96
30	40	24	30	461	663	4117M-12530	37,02	4117M-25030	40,98
32	42	24	32	498	698	4117M-12532	39,59	4117M-25032	44,75

» 4117M-125/-250

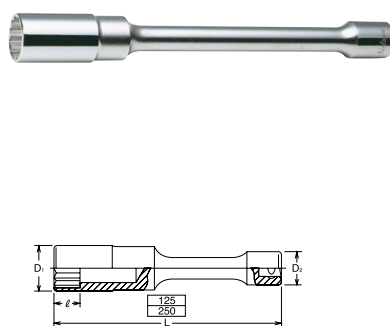

LLAVES DE BUJÍA CON GOMA

mm	D	ℓ	L	⚖️	Ref	€
16	21	19	70	100	4300S16	14,28
18	23,9	21	70	130	4300S18	15,24
20,8	26,9	27	70	135	4300S20,8	15,35

» 4300S

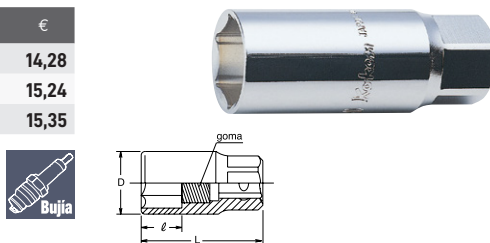

LLAVES DE BUJÍA CON GOMA

mm	D	ℓ	L	⚖️	Ref	€
16	21	13	70	101	4300C16	23,24
18	23,9	12	70	132	4300C18	23,56
20,8	26,9	13,5	70	130	4300C20,8	27,65

» 4300C

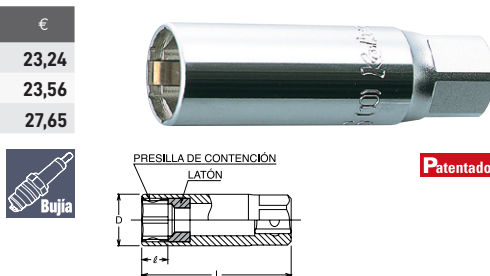

Patentado

VASO PORTA-TUERCA DE INYECCIÓN DIESEL

mm	D1	D2	D3	L	⚖️	Ref	€
22	28,5	27	22	72	150	4122-72	24,76

Para camiones M.B., porta tuerca de inyección post.

» 4122-72

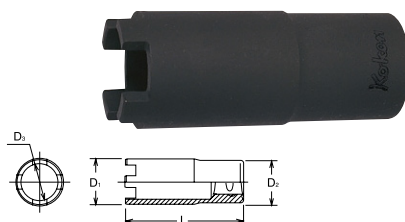

⊙ **VASO PARA INYECTORES DE MOTOR DIESEL**

mm	D1	D2	ℓ	⚖️	Ref	€
27	36,5	33	28	212	SP4305M-77	31,12

» SP4305M-77

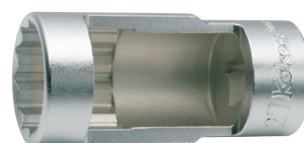

⊙ **VASO ESPECIAL PARA SENSORES LAMBDA**

mm	D1	D2	ℓ	L	↻	⚖️	Ref	€
22	33	30	29	85	8	228	SP4300M-85	44,10
22	33	30	34	110	8	279	SP4300M-110	51,28

» SP4300M-85/-110

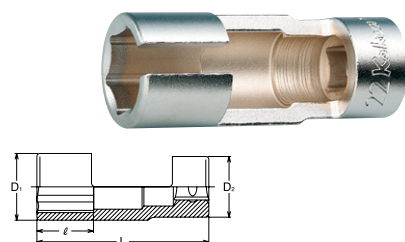

⊙ **VASOS HEXAGONALES CON ARTICULACIÓN UNIVERSAL**

mm	pulgadas	D1	D2	ℓ	L	⚖️	Ref Métrica	€	Ref Pulgadas	€
9		14	25	8,3	63	150	4440M9	25,65		
	3/8	14,8	25	8,8	63	155			4440A3/8	26,73
10		15,3	25	8,8	63	155	4440M10	25,65		
11	7/16	16,5	25	10	65	158	4440M11	25,65	4440A7/16	27,01
12		17,8	25	10,5	65	151	4440M12	25,65		
13	1/2	19	25	11,4	66	152	4440M13	26,29	4440A1/2	27,63
14	9/16	20,3	25	11,4	66	151	4440M14	26,29	4440A9/16	27,63
15		21,5	25	13	68	149	4440M15	26,29		
16	5/8	22,8	25	13	68	150	4440M16	26,29	4440A5/8	27,63
17		24	25	14	69	150	4440M17	26,29		
	11/16	24,6	25	14	69	153			4440A11/16	28,25
18		25,3	25	14	69	150	4440M18	26,89		
19	3/4	26,5	25	15	71	170	4440M19	26,89	4440A3/4	28,25
20		27,8	25	15	71	173	4440M20	27,48		
21		29	25	16	72	176	4440M21	27,48		
22	7/8	30,3	25	16	72	185	4440M22	27,48	4440A7/8	28,88

» 4440M » 4440A

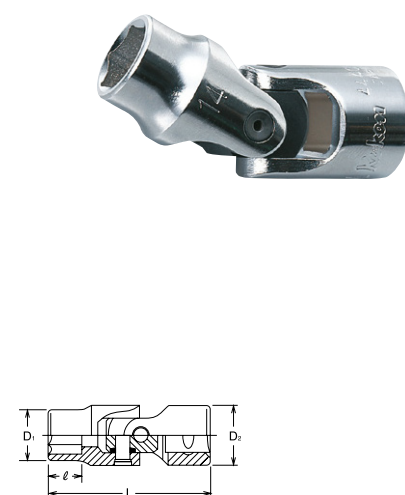

⊕ **VASOS CON PUNTA PHILLIPS**

PH	D	L	⚖️	Ref	€
2	22	60	65	4000-60PH2	10,49
3	22	60	65	4000-60PH3	10,49
4	22	60	67	4000-60PH4	10,49

» 4000-60 (PH)

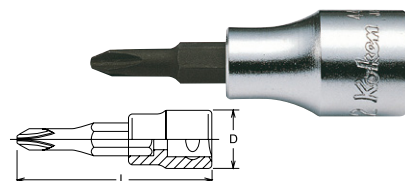

KOKEN IIIIII

⊕ VASOS CON PUNTA PZ

PZ	D	L	⚖	Ref	€
PZ2	22	60	65	4000-60PZ2	11,42
PZ3	22	60	65	4000-60PZ3	11,42

» 4000-60 (PZ)

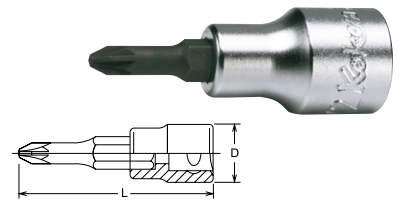

⊖ VASOS CON PUNTA RECTA PARA CABEZA RANURADA

nº	T x W	D	L	⚖	Ref	€
8	1,2 X 8	22	60	65	4005-608	12,10
10	1,6 X 10	22	60	75	4005-6010	13,24
12	2,0 X 12	23	60	111	4005-6012	13,24
14	2,5 X 14	24	60	133	4005-6014	13,24
16	2,5 X 16	24	60	133	4005-6016	13,24

» 4005-60

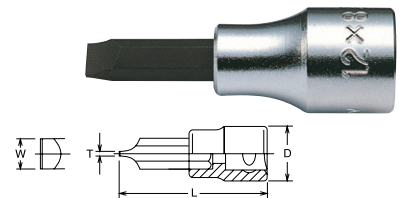

⊙ VASOS CON PUNTA HEXAGONAL

mm	D	⚖				Ref	L50	€	L75	€	L100	€	L160	€
		50	75	100	160									
4	22	61	69	77	103	4010M	50-4	8,14	75-4	8,48	100-4	8,76	160-4	10,60
5	22	62	70	78	104	4010M	50-5	8,14	75-5	8,48	100-5	8,76	160-5	10,60
6	22	64	72	80	106	4010M	50-6	8,14	75-6	8,48	100-6	8,76	160-6	10,60
7	22	65	73	82	108	4010M	50-7	8,83	75-7	9,09	100-7	9,52	160-7	11,37
8	22	66	74	84	110	4010M	50-8	8,83	75-8	9,09	100-8	9,52	160-8	11,37
9	22	73	90	105		4010M	50-9	8,83	75-9	9,09	100-9	9,52		
10	22	75	92	109	126	4010M	50-10	8,83	75-10	9,09	100-10	10,13	160-10	11,84
12	23	105	130	155	180	4010M	50-12	9,52	75-12	9,83	100-12	10,60	160-12	12,61
13	24	120	150	180		4010M	50-13	10,23	75-13	10,43	100-13	11,37		
14	24	120	150	180	260	4010M	50-14	10,23	75-14	10,43	100-14	11,37	160-14	13,54
16	25	150	180	250		4010M	50-16	10,62	75-16	11,05	100-16	11,99		
17	25	150	180	250	360	4010M	50-17	10,62	75-17	11,05	100-17	12,88	160-17	14,44
18	27	200	230	300		4010M	50-18	11,68	75-18	11,84	100-18	12,88		
19	27	200	230	300	415	4010M	50-19	11,68	75-19	11,84	100-19	12,88	160-19	16,42

» 4010M-50/-75/-100/-160

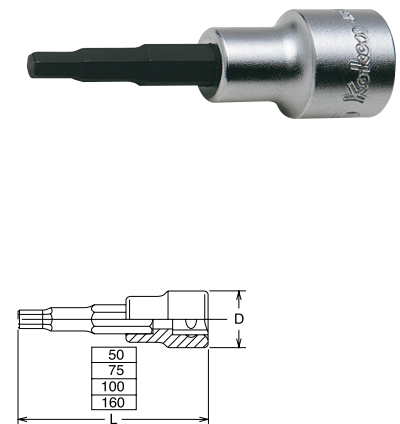

▮ JUEGO DE VASOS EN REGLETA

Ref	Tipo	▮	⚖	▮	▮	€
RS4010/10-L50	⊙ 4010M-50	300	968	10	4, 5, 6, 7, 8, 10, 12, 14, 17, 19	92,96
RS4010/10-L75	⊙ 4010M-75	300	1.207	10	4, 5, 6, 7, 8, 10, 12, 14, 17, 19	95,79

» RS4010/10-L50/-L75



⊙ VASOS CON PUNTA HEXAGONAL

pulg	D	⚖				Ref	L43	€	L60	€	L75	€	L100	€
		43	60	75	100									
5/32	21,1	40	49	52	75	4012A	43-5/32	10,13	60-5/32	12,00	75-5/32	13,20	100-5/32	16,50
3/16	21,1	46	55	58	81	4012A	43-3/16	10,13	60-3/16	12,00	75-3/16	13,20	100-3/16	16,50
7/32	21,1	42	56	62	85	4012A	43-7/32	10,13	60-7/32	12,00	75-7/32	13,20	100-7/32	16,50
1/4	21,1	43	57	65	88	4012A	43-1/4	10,13	60-1/4	12,00	75-1/4	13,20	100-1/4	16,50
9/32	21,1	46	60	70	93	4012A	43-9/32	10,13	60-9/32	12,00	75-9/32	13,20	100-9/32	16,50
5/16	21,1	49	64	74	97	4012A	43-5/16	10,13	60-5/16	12,00	75-5/16	13,20	100-5/16	16,50
11/32	21,1	63	78	88	111	4012A	43-11/32	10,84	60-11/32	12,71	75-11/32	13,91	100-11/32	17,02
3/8	21,5	59	74	86	109	4012A	43-3/8	10,84	60-3/8	12,71	75-3/8	13,91	100-3/8	17,02
7/16	24	74	100	119	142	4012A	43-7/16	10,84	60-7/16	12,71	75-7/16	13,91	100-7/16	17,02
1/2	24	85	111	137	158	4012A	43-1/2	11,21	60-1/2	13,63	75-1/2	14,99	100-1/2	18,03
9/16	24	88	122	148	169	4012A	43-9/16	11,21	60-9/16	13,63	75-9/16	14,99	100-9/16	18,03
5/8	24	100	134	171	192	4012A	43-5/8	11,52	60-5/8	14,10	75-5/8	15,90	100-5/8	20,23
3/4	24	110	159	212	243	4012A	43-3/4	11,65	60-3/4	14,66	75-3/4	17,03	100-3/4	20,23
7/8	26	141	202	262		4012A	43-7/8	12,89	60-7/8	15,76	75-7/8	25,27		

» 4012A-43/-60/-75/-100

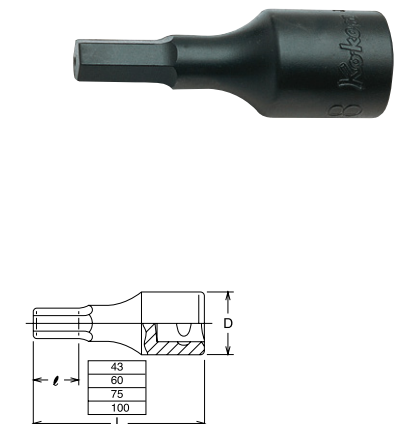

KOKEN IIIIII

□ 1/2" LLAVES DE VASO

● VASOS INHEX

mm	D	⚖				Ref	L43	€	L60	€	L75	€	L100	€
		43	60	75	100									
4	21,1	40	49	52	75	4012M	43-4	9,70	60-4	10,67	75-4	12,50	100-4	15,75
5	21,1	46	55	58	81	4012M	43-5	9,70	60-5	10,67	75-5	12,50	100-5	15,75
6	21,1	42	56	62	85	4012M	43-6	9,70	60-6	10,67	75-6	12,50	100-6	15,75
7	21,1	46	57	65	88	4012M	43-7	9,70	60-7	10,67	75-7	12,50	100-7	15,75
8	21,1	49	60	70	93	4012M	43-8	9,70	60-8	10,67	75-8	12,50	100-8	15,75
9	21,1	63	64	74	97	4012M	43-9	9,70	60-9	10,81	75-9	12,77	100-9	16,31
10	23	63	78	88	111	4012M	43-10	9,81	60-10	10,81	75-10	12,77	100-10	16,31
11	24	74	74	86	109	4012M	43-11	10,46	60-11	11,52	75-11	13,26	100-11	16,65
12	24	81	100	119	142	4012M	43-12	10,46	60-12	11,52	75-12	13,26	100-12	17,06
13	24	85	111	137	158	4012M	43-13	10,60	60-13	11,65	75-13	14,28	100-13	17,26
14	24	88	122	148	169	4012M	43-14	10,60	60-14	11,65	75-14	14,28	100-14	27,26
15	24	91	134	171	192	4012M	43-15	10,90	60-15	11,96	75-15	15,13	100-15	19,30
16	24	100	159	212	243	4012M	43-16	10,90	60-16	11,99	75-16	15,13	100-16	19,30
17	24	101	202	262	215	4012M	43-17	10,90	60-17	11,99	75-17	15,13	100-17	19,29
18	24	106	153	196	227	4012M	43-18	11,05	60-18	12,16	75-18	16,22	100-18	21,85
19	24	110	159	212	243	4012M	43-19	11,05	60-19	12,16	75-19	16,22	100-19	21,85
20	26	130				4012M	43-20	18,93						
21	26	140				4012M	43-21	18,93						
22	26	145				4012M	43-22	18,93						
23	28	169				4012M	43-23	19,23						
24	28	170				4012M	43-24	19,67						
27	32	226				4012M	43-27	23,90						

» 4012M-43/-60/-75/-100

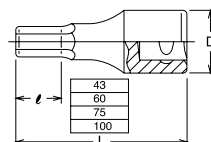

▤ ● JUEGO DE VASOS EN REGLETA

Ref	Tipo	▤	⚖	▤	▤	€
RS4012M/10-L60	● 4012M-60	300	910	10	4, 5, 6, 7, 8, 10, 12, 14, 17, 19	107,71

» RS4012M/10-L60



▤ ● JUEGO DE VASOS EN REGLETA

Ref	Tipo	▤	⚖	▤	▤	€
RS4012A/10-L60	● 4012A-60	300	950	10	3/16, 7/32, 1/4, 5/16, 3/8, 7/16, 1/2, 9/16, 5/8, 3/4	114,83

» RS4012A/10-L60



● VASOS CON PUNTA XZN

M	D	⚖				Ref	L60	€	L100	€	L120	€	L140	€
		60	100	120	140									
M5	22	60	77	86	95	4020	60 M5	11,75	100 M5	12,76	120 M5	13,22	140 M5	15,48
M6	22	61	78	87	96	4020	60 M6	11,75	100 M6	12,76	120 M6	13,22	140 M6	15,48
M8	22	63	80	89	98	4020	60 M8	11,75	100 M8	13,21	120 M8	13,62	140 M8	15,48
M10	23	93	132	152	172	4020	60 M10	12,07	100 M10	13,71	120 M10	14,14	140 M10	16,19
M12	23	97	136	156	176	4020	60 M12	12,76	100 M12	14,67	120 M12	15,13	140 M12	17,31
M14	23	105	144	164	184	4020	60 M14	13,22	100 M14	14,67	120 M14	15,13	140 M14	17,99

» 4020-60/-100/-120/-140

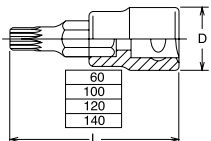

● VASO CON PUNTA PARA TORNILLOS XZN INVOLABLE

MH	D	L	⚖	Ref	€
MH16	24	60	135	4020-60MH	34,23

» 4020-60 (MH)

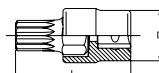

Para tapón de vaciado de caja de cambios AUDI, VW, PORCHE.

VASOS CON PUNTA TORX®

» 4025-60/-140 (T)

TH	D	⚖		Ref L60	€	Ref L140	€
		60	140				
T15	22	58		4025-60T15	9,97		
T20	22	59	94	4025-60T20	9,97	4025-140T20	15,50
T25	22	60	95	4025-60T25	9,97	4025-140T25	15,50
T27	22	60	95	4025-60T27	9,97	4025-140T27	15,50
T30	22	60	95	4025-60T30	9,97	4025-140T30	15,50
T40	22	62	97	4025-60T40	11,37	4025-140T40	17,19
T45	22	64	99	4025-60T45	11,37	4025-140T45	17,19
T50	22	74	129	4025-60T50	11,37	4025-140T50	17,19
T55	22	96	175	4025-60T55	13,34	4025-140T55	17,19
T60	24	122	229	4025-60T60	13,99	4025-140T60	17,19
T70	24	135	245	4025-60T70	36,37	4025-140T70	41,75
T80	24	168	320	4025-60T80	36,37	4025-140T80	41,75

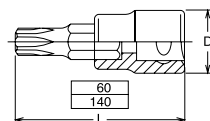

JUEGO DE VASOS EN REGLETA

» RS4025/9-L60

Ref	Tipo	⚖	⚖	⚖	⚖	€
RS4025/9-L60	4025-60	250	700	9	T20, T25, T27, T30, T40, T45, T50, T55, T60	91,35



VASOS CON PUNTA TORX PLUS®

» 4025-60 (IP)

IP	D	L	⚖	Ref	€
20IP	22	60	60	4025-6020IP	14,04
25IP	22	60	60	4025-6025IP	14,04
27IP	22	60	60	4025-6027IP	14,04
30IP	22	60	60	4025-6030IP	14,04
40IP	22	60	60	4025-6040IP	16,01
45IP	22	60	64	4025-6045IP	16,01
50IP	22	60	74	4025-6050IP	16,01
55IP	23	60	96	4025-6055IP	18,55
60IP	24	60	122	4025-6060IP	19,24
70IP	24	60	170	4025-6070IP	23,21

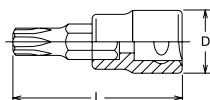

VASOS CON PUNTA PARA TORNILLOS RIBE

» 4027-60/-100

M	D	⚖		Ref L60	€	Ref L100	€
		60	100				
M5	22	60	67	4027-60M5	16,44	4027-100M5	18,24
M6	22	62	68	4027-60M6	16,77	4027-100M6	18,49
M7	22	63	75	4027-60M7	16,98	4027-100M7	19,48
M8	22	64	81	4027-60M8	17,29	4027-100M8	19,48
M9	22	70	90	4027-60M9	18,77	4027-100M9	21,18
M10	22	74	101	4027-60M10	18,77	4027-100M10	21,66
M12	22	96	134	4027-60M12	21,48	4027-100M12	24,52
M13	22	116	155	4027-60M13	24,12	4027-100M13	27,33
M14	24	122	173	4027-60M14	24,12	4027-100M14	27,33
M16	24	135	241	4027-60M16	26,61	4027-100M16	29,13

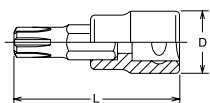

VASO CON PUNTA PARA TORNILLOS XZN INVIOLEABLE

» ST4027-140

Ref	D	L	⚖	€
ST4027-140	23	140	135	25,61

Vasos con punta para perno con cabeza VW / AUDI A6.

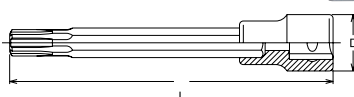

VASOS CON PUNTA RECTA PARA CABEZA RANURADA

» 4101

nº	T x W	D	L	⚖	Ref	€
1	2,7 x 18,6	22	40	59	4101-1	15,72
2	3,7 x 24	24	40	79	4101-2	15,88
3	3,7 x 30	30	40	128	4101-3	26,42

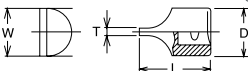

■ VASOS CON MACHO CUADRADO

mm	pulgadas	D	ℓ	L	⚖️	Ref Métrica	€	Ref Pulgadas	€
8		24	10	32	57	4110M8	10,29		
10	3/8	24	10	32	62	4110M10	10,29	4110A3/8	10,29
10,5		24	10	32	64	4110M10,5	10,29		
12		24	10	32	64	4110M12	10,29		
13	1/2	24	10	32	66	4110M13	10,29	4110A1/2	10,04
13,5		24	10	32	67	4110M13,5	10,29		
19		24	15	37	101	4110M19	11,57		
20		24	15	37	114	4110M20	11,77		

» 4110M » 4110A

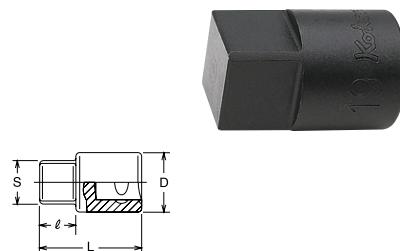

○ ADAPTADOR PARA LLAVE DE TAPÓN VACIADO 106

mm	D1	D2	ℓ	L	⚖️	Ref	€
17	25	24	16	40	82	4102	6,61

» 4102

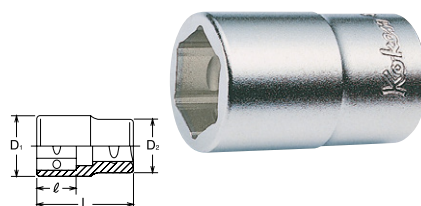

⬡ PUNTA MACHO CUADRADO / HEXAGONAL

nº	H	ℓ1	ℓ2	L	⚖️	Ref	€
8S X 10S	17	8	8	32	40	1068SX10S	8,76
8H X 3/8H	17	8	8	32	38	1068HX3/8H	8,76
10H X 11H	17	8	8	32	42	10610HX11H	8,76
12H X 13H	17	8	8	32	47	10612HX13H	8,76
14H X 17H	17	8	8	32	55	10614HX17H	8,76
19H	17	-	8	24	49	10619H	8,76

» 106

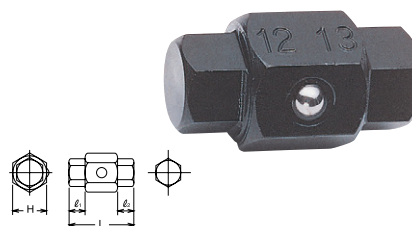

🗑️ ○ ● PUNTO DE PUNTA Y ADAPTADOR

Ref	🗑️	○ ●	⚖️	€
4202	190 x 59 x 45	7	426	65,05

Adaptador

4102 ○ 17

Puntas

106 ● 8Sx10S, 8Hx3/8H, 10Hx11H, 12Hx13H, 14Hx17H, 19H

» 4202



○ PORTA PUNTA

Ref	L	⚖️	€
4137	38	53	9,26

» 4137

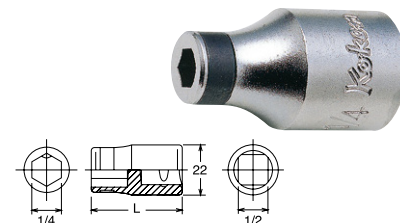

○ PORTA PUNTA

Ref	L	⚖️	€
4138	38	62	8,54

» 4138

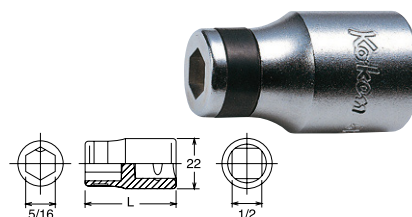

LLAVE DE CARRACA REVERSIBLE CORTA

» **3749S-1/2**

Ref	Tipo	D	T	Dientes	L	⚖	€
3749S-1/2	3749	34	29	24	110	200	43,94

[Pack de repuestos **3749SRK-1/2**]

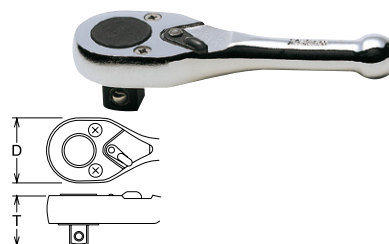

LLAVE DE CARRACA REVERSIBLE CORTA CON BOTÓN DE EXTRACCIÓN RÁPIDA*

» **3749SB-1/2**

Ref	Tipo	D	T	Dientes	L	⚖	€
3749SB-1/2	3749	34	29	24	110	200	56,25

*Los vasos y accesorios se bloquean en posición. Los vasos y alargaderas se extraen de la llave apretando el botón.

[Pack de repuestos **3749SRK-1/2**]

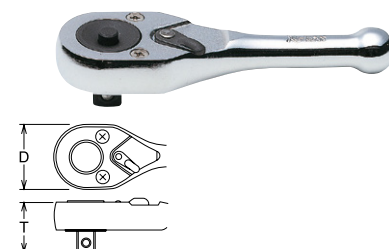

LLAVE DE CARRACA REVERSIBLE

» **4750J**

Ref	Tipo	D	T	Dientes	L	⚖	€
4750J	4750	38	35,9	30	250	508	60,34

[Pack de repuestos **4750RK**]

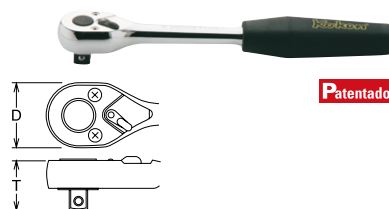

LLAVE DE CARRACA REVERSIBLE

» **4750P**

Ref	Tipo	D	T	Dientes	L	⚖	€
4750P	4750	38	35,9	30	250	553	68,73

[Pack de repuestos **4750RK**]

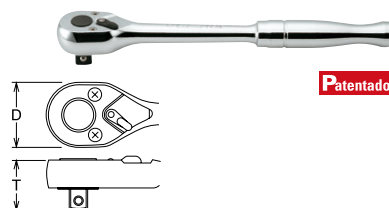

LLAVE DE CARRACA REVERSIBLE CON BOTÓN DE EXTRACCIÓN RÁPIDA*

» **4750JB**

Ref	Tipo	D	T	Dientes	L	⚖	€
4750JB	4750	38	35,9	30	250	508	87,71

*Los vasos y accesorios se bloquean en posición. Los vasos y alargaderas se extraen de la llave apretando el botón.

[Pack de repuestos **4750BRK**]

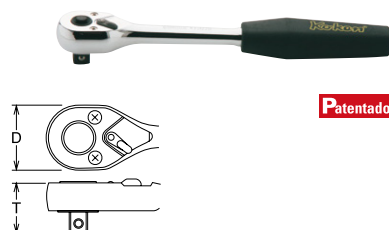

KOKEN IIIIII

LLAVE DE CARRACA REVERSIBLE

Ref	Tipo	D	T	Dientes	L	⚖	€
4752J	4752	35	38,8	45	250	470	76,00

[Pack de repuestos 4752RK]



» 4752J



Patentado

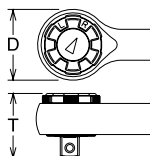

LLAVE DE CARRACA REVERSIBLE LARGA

Ref	Tipo	D	T	Dientes	L	⚖	€
4749J-380	4749	44,6	33	24	380	743	75,68

[Pack de repuestos 4749RK]



» 4749J-380

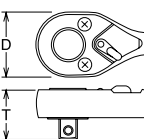

LLAVE DE CARRACA REVERSIBLE LARGA

Ref	Tipo	D	T	Dientes	L	⚖	€
4753P-410	4753	38	36,2	24	410	790	112,79

[Pack de repuestos 4753RK]



» 4753P-410

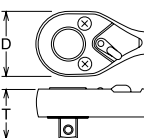

LLAVE DE CARRACA ARTICULADA, REVERSIBLE

Ref	Tipo	D	T	Dientes	L	⚖	€
4774J	4774	38	36,2	24	330	685	78,54

[Pack de repuestos 4753RK]



» 4774J

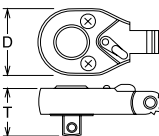

LLAVE DE CARRACA ARTICULADA, REVERSIBLE

Ref	Tipo	D	T	Dientes	L	⚖	€
4774P	4774	38	36,2	24	330	700	75,72

[Pack de repuestos 4753RK]



» 4774P

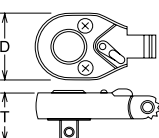

KOKEN IIIIII

LLAVE DE CARRACA ARTICULADA, REVERSIBLE

» **4774P-450**

Ref	Tipo	D	T	Dientes	L	⚖	€
4774P-450	4774	38	36,2	24	450	790	100,04

[Pack de repuestos **4753RK**]

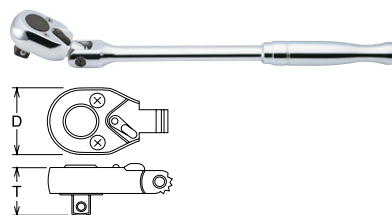

LLAVE DE CARRACA ARTICULADA, REVERSIBLE CON BOTÓN DE EXTRACCIÓN RÁPIDA

» **4774JB**

Ref	Tipo	D	T	Dientes	L	⚖	€
4774JB	4774	38	36,2	24	330	685	88,40

[Pack de repuestos **4753RK**]

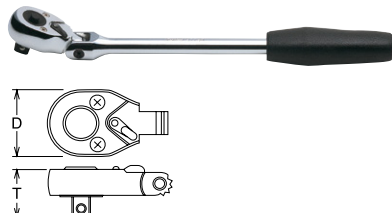

ADAPTADOR DE CARRACA

» **4755**

Ref	L	⚖	€
4755	65	270	51,75

[Pack de repuestos **4755RK**]



MANGOS ARTICULADOS

» **4768J-380/-450**

Ref	L	⚖	€
4768J-380	380	600	44,38
4768J-450	450	690	47,47

[Pack de repuestos **4768RK**]



MANGOS ARTICULADOS

» **4768P-380/-450**

Ref	L	⚖	€
4768P-380	380	665	49,87
4768P-450	450	748	54,87

[Pack de repuestos **4768RK**]



MANGO ACODADO

» **4747**

Ref	L	⚖	€
4747	260 X 50	470	18,47



KOKEN IIIIII

ALARGADERAS

Ref	L	⚖️	€
4760-50	50	92	10,86
4760-75	75	138	11,00
4760-100	100	158	12,65
4760-125	125	194	12,65
4760-150	150	266	16,26
4760-200	200	295	16,37
4760-250	250	358	16,37
4760-300	300	492	23,67
4760-400	400	650	31,20
4760-500	500	808	39,60
4760-600	600	968	39,60
4760-900	900	1430	70,10
4760-1000	1000	1593	98,30

ALARGADERAS EN CAJA DE PLÁSTICO

Ref	Tipo	⚖️	📦	📏	€
PK4760/5	🔑 4760	1.050	5	50, 75, 125, 150, 250	92,10

ALARGADERAS ARTICULADAS-FIJAS*

Ref	L	⚖️	€
4763-50	50	95	11,55
4763-75	75	111	15,35
4763-125	125	157	16,80
4763-150	150	181	21,55
4763-250	250	357	21,55
4763-400	400	650	47,18

*Dos formas de utilización: Una como alargadera flexible para poder trabajar con un ángulo de 15° y otra para utilizarse como alargadera normal. Esta aplicación está patentada.



ALARGADERAS ARTICULADAS-FIJAS EN CAJA DE PLÁSTICO

Ref	Tipo	⚖️	📦	📏	€
PK4763/5	🔑 4763	950	5	50, 75, 125, 150, 250	86,02

ARTICULACIÓN UNIVERSAL

Ref	L	⚖️	€
4770	62,4	150	21,10

ARTICULACIÓN UNIVERSAL

Ref	L	⚖️	€
4771	57,7	113	35,01

» 4760

-50/-75/-100/-125/-150/-200/
-250/-300/-400/-500/-600/-900/
-1000



Patentado

» PK4760/5



» 4763-50/-75/-125/-150/-250



Patentado

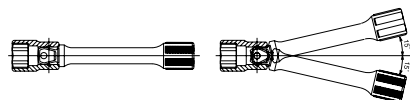

» PK4763/5



» 4770

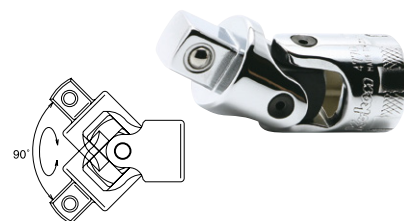

» 4771

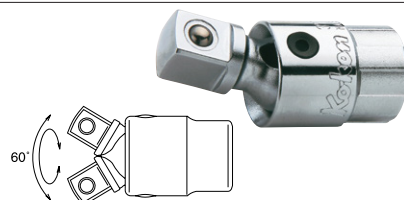

MANIVELA RÁPIDA

» 4780-400

Ref	L		€
4780-400	400	644	26,11



MANGO CORREDIZO

» 4785

Ref	L		€
4785	300	410	17,40



Patentado



MANGOS ACODADOS

» 4788-250/-300/-450

Ref	L		€
4788-250	250	417	20,41
4788-300	300	503	22,08
4788-450	450	743	29,49



MANGOS ACODADOS

» 4433A-35/-75/-125-250/-600

Ref	L		€
4433A-35	35	50	10,18
4433A-75	75	120	11,80
4433A-125	125	164	11,80
4433A-250	250	275	15,90
4433A-600	600	530	33,30

[Garantizado 290 Nm]



□ 1/2" x ▽ 3/8"

ADAPTADOR

» 4466A

Ref	L		€
4466A	42	108	12,81

□ 1/2" x ▽ 3/4"



JUEGO DE VASOS

» 4223M-01 » 4223M-06

Ref				€
○ 4223M-01	415 x 120 x 50	15	2.600	173,38
○ 4223M-06	415 x 120 x 50	15	2.600	173,38



Vasos 4223M-01

4401M ○ 10, 11, 12, 13, 14, 15, 16, 17, 18
19, 21, 22

Vasos 4223M-06

4406M ○ 10, 11, 12, 13, 14, 15, 16, 17, 18
19, 21, 22

Accesorios

4753J
4760-125
4770

□ 1/2" LLAVES DE VASO

○○ EXPOSITORES

Ref				€
S4240M-01	510 x 150 x 230	○ 117 x 4401M	13.000	442,35
S4240M-06	510 x 150 x 230	○ 117 x 4406M	13.000	442,35

Vasos 3217M-00

9 x 10 mm	9 x 13 mm	9 x 16 mm	7 x 21 mm	6 x 24 mm	4 x 32 mm
9 x 11 mm	9 x 14 mm	8 x 17 mm	6 x 22 mm	5 x 27 mm	
9 x 12 mm	9 x 15 mm	7 x 19 mm	6 x 23 mm	5 x 30 mm	

Ref				€
S4240A-00	510 x 150 x 230	○ 117 x 4400A	13.000	772,71
S4240A-05	510 x 150 x 230	○ 117 x 4405A	13.000	772,71

Vasos 3217M-00

9 x 3/8 pulg.	9 x 9/16 pulg.	7 x 3/4 pulg.	6 x 15/16 pulg.	5 x 1-1/8 pulg.
9 x 7/6 pulg.	9 x 5/8 pulg.	7 x 13/16 pulg.	5 x 1 pulg.	5 x 1-3/16 pulg.
9 x 1/2 pulg.	8 x 11/16 pulg.	6 x 7/8 pulg.	5 x 1-1/16 pulg.	5 x 1-1/4 pulg.

» S4240M-01/-06 » S4240M-00/-05



Patentado

○ ○ ○ ○ JUEGO DE VASOS

Ref				€
○ 4241M-01	446 x 266 x 50	28	6.500	338,87
○ 4241M-06	446 x 266 x 50	28	6.500	338,87
○ 4241M-10	446 x 266 x 50	28	6.500	342,72

Vasos 4241M-01

4401M ○ 10, 11, 12, 13, 14, 15, 16, 17, 18, 19, 20, 21, 22, 23, 24, 25, 26, 27, 28, 29, 30, 32

Vasos 4241M-06

4406M ○ 10, 11, 12, 13, 14, 15, 16, 17, 18, 19, 20, 21, 22, 23, 24, 25, 26, 27, 28, 29, 30, 32

Vasos 4241M-10

4410M ○ 10, 11, 12, 13, 14, 15, 16, 17, 18, 19, 20, 21, 22, 23, 24, 25, 26, 27, 28, 29, 30, 32

Accesorios

4753J	
4760-125	
4760-250	
4768J-380	
4770	
4785	

» 4241M-01/-06/-10



○ ○ ○ ○ JUEGO DE VASOS

Ref				€
○ 4241A-00	445 x 190 x 50	19	4.900	276,88
○ 4241A-05	445 x 190 x 50	19	4.900	276,88

Vasos 4241A-00

4400A ○ 3/8, 7/16, 1/2, 9/16, 5/8, 11/16, 3/4, 13/16, 7/8, 15/16, 1-1/16, 1-1/8, 1-1/4

Vasos 4241A-05

4405A ○ 3/8, 7/16, 1/2, 9/16, 5/8, 11/16, 3/4, 13/16, 7/8, 15/16, 1-1/16, 1-1/8, 1-1/4

Accesorios

4753J	
4760-125	
4760-250	
4768J-380	
4770	
4785	

» 4241A-00/-05



JUEGO DE VASOS

Ref				€
○ 4249M-01	445 x 190 x 50	20	4.800	225,40
○ 4249M-06	445 x 190 x 50	20	4.800	225,40

Vasos 4249M-01

4401M ○ 10, 11, 12, 13, 14, 15, 16, 17, 18, 19, 21, 22, 24, 27, 30

Vasos 4249M-06

4406M ○ 10, 11, 12, 13, 14, 15, 16, 17, 18, 19, 21, 22, 24, 27, 30

Accesorios

4753J	
4760-125	
4760-250	
4770	
4785	

» 4249M-01/-06



JUEGO DE VASOS

Ref				€
○ 4250M-01	445 x 190 x 50	18	4.700	225,54
○ 4250M-06	445 x 190 x 50	18	4.700	225,54
○ 4250M-10	445 x 190 x 50	18	4.700	225,54

Vasos 4250M-01

4401M ○ 10, 11, 12, 13, 14, 15, 17, 19, 22, 24, 27, 30, 32

Vasos 4250M-06

4406M ○ 10, 11, 12, 13, 14, 15, 17, 19, 22, 24,, 27, 30, 32

Vasos 4250M-10

4410M ○ 10, 11, 12, 13, 14, 15, 17, 19, 22, 24, 27, 30, 32

Accesorios

4753J	
4760-125	
4760-250	
4770	
4785	

» 4250M-01/-06/-10



JUEGO DE VASOS

Ref				€
○ 4250M-01	330 x 68 x 48	22	3.200	159,35
○ 4250M-06	330 x 68 x 48	22	3.200	184,24
○ 4250M-10	330 x 68 x 48	22	3.200	192,60

Vasos 4250M-01

4401M ○ 10, 11, 12, 13, 14, 15, 16, 17, 18, 19, 20, 21, 22, 23, 24, 25, 26, 27, 28, 29, 30, 32

Vasos 4250M-06

4406M ○ 10, 11, 12, 13, 14, 15, 16, 17, 18, 19, 20, 21, 22, 23, 24, 25, 26, 27, 28, 29, 30, 32

Vasos 4250M-10

4410M ○ 10, 11, 12, 13, 14, 15, 16, 17, 18, 19, 20, 21, 22, 23, 24, 25, 26, 27, 28, 29, 30, 32

» 4251M-01/-06/-10



JUEGO DE VASOS

Ref				€
○ 4252M-01	168 x 60 x 42	13	1.200	99,34
○ 4252M-06	168 x 60 x 42	13	1.200	99,34
○ 4252M-10	168 x 60 x 42	13	1.200	103,50

Vasos 4252M-01

4401M ○ 10, 11, 12, 13, 14, 15, 16, 17, 18, 19, 20, 21, 22

Vasos 4252M-06

4406M ○ 10, 11, 12, 13, 14, 15, 16, 17, 18, 19, 20, 21, 22

Vasos 4252M-10

4410M ○ 10, 11, 12, 13, 14, 15, 16, 17, 18, 19, 20, 21, 22

» 4252M-01/-06/-10



□ 1/2" LLAVES DE VASO

🏠 🔄 JUEGO DE VASOS

Ref	🏠	🔲	⚖️	€
○ 4254	215 x 80 x 47	12	1.070	135,21

Vasos 4241M-01

3425	🔄 E6, E8
4425	🔄 E10, E12, E14
3325	🔄 E6, E8
4325	🔄 E10, E12, E14

Accesorios

4433A-35	🔑
4763-50	🔑

» 4254



🏠 ○ ○ ○ JUEGO DE VASOS

Ref	🏠	🔲	⚖️	€
○ 4262M-01	445 x 190 x 50	20	4.400	233,36
○ 4262M-06	445 x 190 x 50	20	4.400	233,36
○ 4262M-10	445 x 190 x 50	20	4.400	233,36

Vasos 4256M-01

4401M	○ 8, 9, 10, 11, 12, 13, 14, 15, 16, 17, 18, 19, 21, 22, 24, 27
-------	--

Vasos 4256M-06

4406M	○ 8, 9, 10, 11, 12, 13, 14, 15, 16, 17, 18, 19, 21, 22, 24, 27
-------	--

Vasos 4256M-10

4410M	○ 8, 9, 10, 11, 12, 13, 14, 15, 16, 17, 18, 19, 21, 22, 24, 27
-------	--

Accesorios

4753J	🔑
4760-125	🔑
4760-250	🔑
4770	🔑
4785	🔑

» 4262M-01/-06/-10



🏠 ○ ○ JUEGO DE VASOS

Ref	🏠	🔲	⚖️	€
○ 4272AM-01	445 x 190 x 50	29	5.000	278,36
○ 4272AM-06	445 x 190 x 50	29	5.000	278,36

Vasos 4272AM-01

4401M	○ 10, 11, 12, 13, 14, 15, 16, 17, 18, 19, 21, 22, 24
-------	--

4400A	○ 3/8, 7/16, 1/2, 9/16, 5/8, 11/16, 3/4, 13/16, 7/8, 15/16, 1
-------	---

Vasos 4272AM-06

4401M	○ 10, 11, 12, 13, 14, 15, 16, 17, 18, 19, 21, 22, 24
-------	--

4400A	○ 3/8, 7/16, 1/2, 9/16, 5/8, 11/16, 3/4, 13/16, 7/8, 15/16, 1
-------	---

Accesorios

4753J	🔑
4760-125	🔑
4760-250	🔑
4770	🔑
4785	🔑

» 4272AM-01/-06



🏠 ○ JUEGO DE VASOS

Ref	🏠	🔲	⚖️	€
4277	445 x 190 x 50	27	5.660	433,86

Vasos

4406M	○ 10, 11, 12, 13, 14, 15, 16, 17, 18, 19, 21, 22, 24
-------	--

4305M	○ 10, 11, 12, 13, 14, 15, 16, 17, 18, 19, 21, 22, 24
-------	--

Accesorios

4750J	🔑
4760-125	🔑
4768J-380	🔑

» 4277





○ VASOS HEXAGONALES

» 6400M » 6400A

mm	pulgadas	D1	D2	ℓ	L	⚖	Ref Métrica	€	Ref Pulgadas	€
14		22,1	34	11	50	160	6400M14	12,61		
16	5/8	24,6	34	12	50	167	6400M16	12,61	6400A5/8	13,21
17		26	34	12,5	50	175	6400M17	12,61		
18	11/16	27	34	13	50	178	6400M18	12,61	6400A11/16	13,21
19	3/4	28,5	34	13,5	50	179	6400M19	12,61	6400A3/4	13,21
20	25/32	29,5	34	14	50	185	6400M20	12,61	6400A5/32	13,21
21	13/16	31	34	14,5	50	185	6400M21	12,61	6400A13/16	13,21
22	7/8	32	34	15	50	187	6400M22	12,61	6400A7/8	13,21
23		33,5	34	16	50	187	6400M23	12,61		
24	15/16	34,5	34	17	50	200	6400M24	13,34	6400A15/16	14,14
25	31/32	36	34	17,5	50	217	6400M25	13,34	6400A31/32	14,14
26	1	37	34	18	50	222	6400M26	13,34	6400A1	14,14
27	1-1/16	38,5	37	19	53	254	6400M27	14,14	6400A1-1/16	14,72
28		39,5	38	19,5	53	298	6400M28	14,28		
29	1-1/8	41	38	20	53	292	6400M29	16,29	6400A1-1/8	17,19
30	1-3/16	42	38	21	55	301	6400M30	16,29	6400A1-3/16	17,19
31		43,5	38	22	55	294	6400M31	16,29		
32	1-1/4	44,5	40	23	57	351	6400M32	16,29	6400A1-1/4	17,19
33	1-5/16	46	40	23,5	57	384	6400M33	19,55	6400A1-5/16	20,58
34		47	40	24	57	397	6400M34	19,55		
35	1-3/8	48,5	42	24,5	57	422	6400M35	19,55	6400A1-3/8	20,58
36		49,5	42	25	59	438	6400M36	21,82		
37	1-7/16	51	42	25,5	59	484	6400M37	21,82	6400A1-7/16	22,89
38	1-1/2	52	45	26	59	523	6400M38	22,73	6400A1-1/2	23,94
39		53,5	45	26,5	59	538	6400M39	25,95		
40	1-9/16	54,5	45	27	59	550	6400M40	25,95	6400A1-9/16	27,22
41	1-5/8	56	47	28	62	633	6400M41	25,95	6400A1-5/8	27,22
42		57	47	28,5	62	652	6400M42	27,78		
43	1-11/16	58,5	47	29	62	659	6400M43	29,35	6400A1-11/16	30,90
44	1-3/4	59,5	47	29,5	62	657	6400M44	32,14	6400A1-3/4	33,34
45		61	47	30	62	734	6400M45	32,14		
46	1-13/16	62	47	31	68	791	6400M46	32,14	6400A1-13/16	33,34
47		63,5	48	31,5	68	816	6400M47	34,86		
48	1-7/8	64,5	50	32	68	800	6400M48	34,86	6400A1-7/8	36,55
	1-15/16	66	48	32,5	68	928			6400A 1-15/16	40,86
50		67	48	34	68	880	6400M50	38,85		
	2	68,5	52	34,5	68	949			6400A2	44,82
52		69,5	53	33	72	925	6400M52	44,56		
	2-1/16	71	54	33	72	983			6400A2-1/16	46,98
54	2-1/8	72	55	33	72	1.040	6400M54	47,15	6400A2-1/8	49,42
55		73,5	53	36	72	1.006	6400M55	47,15		
56	2-3/16	74,5	53	36	72	1.092	6400M56	47,15	6400A2-3/16	49,42
57	2-1/4	76	53	36	72	1.169	6400M57	47,15	6400A2-1/4	49,42
58		77	53	36	72	1.149	6400M58	49,42		
	2-5/16	78,5	53	36	72	1.344			6400A2-5/16	65,59
60	2-3/8	79,5	58	39	76	1.402	6400M60	62,32	6400A2-3/8	65,59
	2-7/16	82	58	39	76	1.420			6400A2-7/16	65,59
63		83,5	58	39	76	1.494	6400M63	62,32		
	2-1/2	84,5	58	39	76	1.497			6400A2-1/2	65,59
65	2-9/16	86	63	42	80	1.608	6400M65	73,37	6400A2-9/16	77,40
	2-5/8	88,5	63	42	80	1.709			6400A2-5/8	83,82
	2-11/16	89,5	63	42	80	1.634			6400A2-11/16	83,82
70	2-3/4	92	68	45	84	1.785	6400M70	81,38	6400A2-3/4	85,84
	2-13/16	94,5	68	45	84	2.018			6400A2-13/16	85,84
	2-7/8	96	68	45	84	2.062			6400A2-7/8	85,84
75	2-15/16	98,5	73	48	86	2.186	6400M75	104,56	6400A2-15/16	109,78
	3	101	73	48	86	2.309			6400A3	109,78
78		102,1	73	55	86	2.425	6400M78			
80	3-1/8	104,5	78	52	90	2.475	6400M80	112,25	6400A3-1/8	117,90
85		111	78	52	90	2.620	6400M85	119,91		

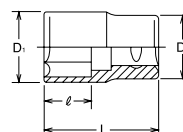

» 6405M » 6405A

○ VASOS BIHEXAGONALES

mm	pulgadas	D1	D2	ℓ	L	⚖	Ref Métrica	€	Ref Pulgadas	€
14		22,1	34	11	50	160	6405M14	12,61		
16	5/8	24,6	34	12	50	167	6405M16	12,61	6405A5/8	13,21
17		26	34	12,5	50	175	6405M17	12,61		
18	11/16	27	34	13	50	178	6405M18	12,61	6405A11/16	13,21
19	3/4	28,5	34	13,5	50	179	6405M19	12,61	6405A3/4	13,21
20	25/32	29,5	34	14	50	185	6405M20	12,61	6405A25/32	13,21
21	13/16	31	34	14,5	50	185	6405M21	12,61	6405A13/16	13,21
22	7/8	32	34	15	50	187	6405M22	12,61	6405A7/8	13,21
23		33,5	34	16	50	187	6405M23	12,61		
24	15/16	34,5	34	17	50	200	6405M24	13,34	6405A15/16	14,14
25	31/32	36	34	17,5	50	217	6405M25	13,34	6405A31/32	14,14
26	1	37	34	18	50	222	6405M26	13,34	6405A1	14,14
27	1-1/16	38,5	37	19	53	254	6405M27	14,14	6405A1-1/16	14,72
28		39,5	38	19,5	53	298	6405M28	14,28		
29	1-1/8	41	38	20	53	292	6405M29	16,29	6405A1-1/8	17,19
30	1-3/16	42	38	21	55	301	6405M30	16,29	6405A1-3/16	17,19
31		43,5	38	22	55	294	6405M31	16,29		
32	1-1/4	44,5	40	23	57	351	6405M32	16,29	6405A1-1/4	17,19
33	1-5/16	46	40	23,5	57	384	6405M33	19,55	6405A1-5/16	20,58
34		47	40	24	57	397	6405M34	19,55		
35	1-3/8	48,5	42	24,5	57	422	6405M35	19,55	6405A1-3/8	20,58
36		49,5	42	25	59	438	6405M36	21,82		
37	1-7/16	51	42	25,5	59	484	6405M37	21,82	6405A1-7/16	22,89
38	1-1/2	52	45	26	59	523	6405M38	22,73	6405A1-1/2	23,94
39		53,5	45	26,5	59	538	6405M39	25,95		
40	1-9/16	54,5	45	27	59	550	6405M40	25,95	6405A1-9/16	27,22
41	1-5/8	56	47	28	62	633	6405M41	25,95	6405A1-5/8	27,22
42		57	47	28,5	62	652	6405M42	27,78		
43	1-11/16	58,5	47	29	62	659	6405M43	29,35	6405A1-11/16	30,90
44	1-3/4	59,5	47	29,5	62	657	6405M44	32,14	6405A1-3/4	33,34
45		61	47	30	62	734	6405M45	32,14		
46	1-13/16	62	47	31	68	791	6405M46	32,14	6405A1-13/16	33,34
47		63,5	48	31,5	68	816	6405M47	34,86		
48	1-7/8	64,5	50	32	68	800	6405M48	34,86	6405A1-7/8	36,55
	1-15/16	66	48	32,5	68	928			6405A 1-15/16	40,86
50		67	48	34	68	880	6405M50	38,85		
	2	68,5	52	34,5	68	949			6405A2	44,82
52		69,5	53	33	72	925	6405M52	44,56		
	2-1/16	71	54	33	72	983			6405A2-1/16	46,98
54	2-1/8	72	55	33	72	1.040	6405M54	47,15	6405A2-1/8	49,42
55		73,5	53	36	72	1.006	6405M55	47,15		
56	2-3/16	74,5	53	36	72	1.092	6405M56	47,15	6405A2-3/16	49,42
57	2-1/4	76	53	36	72	1.169	6405M57	47,15	6405A2-1/4	49,42
58		77	53	36	72	1.149	6405M58	49,42		
	2-5/16	78,5	53	36	72	1.344			6405A2-5/16	65,59
60	2-3/8	79,5	58	39	76	1.402	6405M60	62,32	6405A2-3/8	65,59
	2-7/16	82	58	39	76	1.420			6405A2-7/16	65,59
63		83,5	58	39	76	1.494	6405M63	62,32		
	2-1/2	84,5	58	39	76	1.497			6405A2-1/2	65,59
65	2-9/16	86	63	42	80	1.608	6405M65	73,37	6405A2-9/16	77,40
	2-5/8	88,5	63	42	80	1.709			6405A2-5/8	83,82
	2-11/16	89,5	63	42	80	1.634			6405A2-11/16	83,82
70	2-3/4	92	68	45	84	1.785	6405M70	81,38	6405A2-3/4	85,84
	2-13/16	94,5	68	45	84	2.018			6405A2-13/16	85,84
	2-7/8	96	68	45	84	2.062			6405A2-7/8	85,84
75	2-15/16	98,5	73	48	86	2.186	6405M75	104,56	6405A2-15/16	109,78
	3	101	73	48	86	2.309			6405A3	109,78
78		102,1	73	55	86	2.425	6405M78			
80	3-1/8	104,5	78	52	90	2.475	6405M80	112,25	6405A3-1/8	117,91
85		111	78	52	90	2.620	6405M85	119,91		

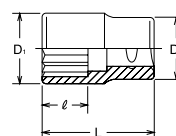

○ VASOS HEXAGONALES LARGOS

» 6300M » 6300A

mm	pulgadas	D1	D2	ℓ	L	⚖	Ref Métrica	€	Ref Pulgadas	€
17		26	34	18	90	278	6300M17	26,54		
18		27	34	19	90	281	6300M18	26,54		
19	3/4	28,5	34	20	90	292	6300M19	26,54	6300A3/4	27,94
20	25/32	29,5	34	21	90	334	6300M20	26,54	6300A35/32	27,94
21	13/16	31	34	22	90	343	6300M21	26,54	6300A13/16	27,94
22	7/8	32	34	23	90	347	6300M22	26,54	6300A7/8	27,94
23		33,5	34	24	90	361	6300M23	26,54		
24	15/16	34,5	34	25	90	352	6300M24	27,78	6300A15/16	29,15
25		36	34	26	90	369	6300M25	27,78		
26	1	37	34	27	90	384	6300M26	27,78	6300A1	29,15
27	1-1/16	38,5	37	28	90	425	6300M27	28,11	6300A1-1/16	29,50
28		39,5	38	29	90	470	6300M28	28,72		
29	1-1/8	41	38	30	90	503	6300M29	32,11	6300A1-1/8	31,48
30	1-3/16	42	38	31	90	503	6300M30	32,11	6300A1-3/16	33,62
31		43,5	38	32	90	517	6300M31	32,11		
32	1-1/4	44,5	40	34	90	544	6300M32	32,11	6300A1-1/4	33,62
33	1-5/16	46	40	34	90	557	6300M33	32,11	6300A1-5/16	39,48
34		47	40	35	90	570	6300M34	37,45		
35	1-3/8	48,5	42	36	90	622	6300M35	37,45	6300A1-3/8	38,53
36		49,5	42	37	90	631	6300M36	41,75		
	1-7/16	51	42	38	90	656			6300A1-7/16	44,21
38	1-1/2	52	45	39	90	710	6300M38	41,75	6300A1-1/2	44,21
40	1-9/16	54,5	45	41	90	742	6300M40	47,47	6300A1-9/16	
41	1-5/8	56	47	42	90	802	6300M41	47,47	6300A1-5/8	49,78
42		57	47	43	90	829	6300M42	57,57		
	1-11/16	58,5	47	44	90	831	6300M43		6300A1-11/16	60,79
44	1-3/4	59,5	47	45	90	838	6300M44	57,57	6300A1-3/4	60,79
46	1-13/16	62	47	47	90	906	6300M46	57,57	6300A1-13/16	60,79
48		64,5	50	49	90	998	6300M48	57,57		
50		67	48	51	90	1.005	6300M50	59,57		
	2	68,5	52	52	90	1.061			6300A2	62,81
52		69,5	53	49	100	1.270	6300M52	59,57		
53	2-1/16	71	54	49	100	1.338			6300A2-1/16	62,81
54	2-1/8	72	55	49	100	1.351	6300M54	85,84	6300A2-1/8	90,28
55		73,5	53	52	100	1.388	6300M55	85,84		
56	2-3/16	74,5	53	52	100	1.389	6300M56	85,84	6300A2-3/16	90,28
57	2-1/4	76	53	52	100	1.467	6300M57	87,22	6300A2-1/4	90,28
58		77	53	52	100	1.480	6300M58	90,28		
	2-5/16	78,5	53	52	100	1.787			6300A2-5/16	99,17
60	2-3/8	79,5	58	55	100	1.626	6300M60	110,56	6300A2-3/8	116,23
	2-7/16	82	58	55	100	1.715			6300A2-7/16	119,93
63		83,5	58	55	100	1.740	6300M63	113,76		
65		86	63	65	100	1.939	6300M65	113,76		

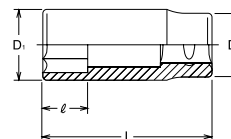

KOKEN IIIIII

» 6305M » 6305A



KOKEN IIIIII

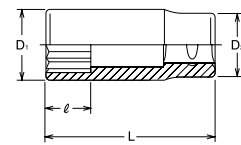

» 6012M-75

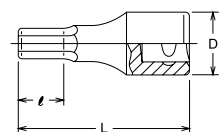

○ VASOS BIHEXAGONALES LARGOS

mm	pulgadas	D1	D2	ℓ	L	⚖	Ref Métrica	€	Ref Pulgadas	€
17		26	34	18	90	278	6305M17	26,54		
18		27	34	19	90	281	6305M18	26,54		
19	3/4	28,5	34	20	90	292	6305M19	26,54	6305A3/4	27,94
20	25/32	29,5	34	21	90	334	6305M20	26,54	6305A35/32	27,94
21	13/16	31	34	22	90	343	6305M21	26,54	6305A13/16	27,94
22	7/8	32	34	23	90	347	6305M22	26,54	6305A7/8	27,94
23		33,5	34	24	90	361	6305M23	26,54		
24	15/16	34,5	34	25	90	352	6305M24	27,78	6305A15/16	29,15
25		36	34	26	90	369	6305M25	27,78		
26	1	37	34	27	90	384	6305M26	27,78	6305A1	29,15
27	1-1/16	38,5	37	28	90	425	6305M27	28,11	6305A1-1/16	29,50
28		39,5	38	29	90	470	6305M28	28,72		
29	1-1/8	41	38	30	90	503	6305M29	32,11	6305A1-1/8	31,48
30	1-3/16	42	38	31	90	503	6305M30	32,11	6305A1-3/16	33,62
31		43,5	38	32	90	517	6305M31	32,11		
32	1-1/4	44,5	40	34	90	544	6305M32	32,11	6305A1-1/4	33,62
33	1-5/16	46	40	34	90	557	6305M33	32,11	6305A1-5/16	39,48
34		47	40	35	90	570	6305M34	37,45		
35	1-3/8	48,5	42	36	90	622	6305M35	37,45	6305A1-3/8	38,53
36		49,5	42	37	90	631	6305M36	41,75		
	1-7/16	51	42	38	90	656			6305A1-7/16	44,21
38	1-1/2	52	45	39	90	710	6305M38	41,75	6305A1-1/2	44,21
40	1-9/16	54,5	45	41	90	742	6305M40	47,47	6305A1-9/16	
41	1-5/8	56	47	42	90	802	6305M41	47,47	6305A1-5/8	49,78
42		57	47	43	90	829	6305M42	57,57		
	1-11/16	58,5	47	44	90	831	6305M43		6305A1-11/16	60,79
44	1-3/4	59,5	47	45	90	838	6305M44	57,57	6305A1-3/4	60,79
46	1-13/16	62	47	47	90	906	6305M46	57,57	6305A1-13/16	60,79
48		64,5	50	49	90	998	6305M48	57,57		
50		67	48	51	90	1.005	6305M50	59,57		
	2	68,5	52	52	90	1.061			6305A2	62,81
52		69,5	53	49	100	1.270	6305M52	59,57		
53	2-1/16	71	54	49	100	1.338			6305A2-1/16	62,81
54	2-1/8	72	55	49	100	1.351	6305M54	85,84	6305A2-1/8	90,28
55		73,5	53	52	100	1.388	6305M55	85,84		
56	2-3/16	74,5	53	52	100	1.389	6305M56	85,84	6305A2-3/16	90,28
57	2-1/4	76	53	52	100	1.467	6305M57	87,22	6305A2-1/4	90,28
58		77	53	52	100	1.480	6305M58	90,28		
	2-5/16	78,5	53	52	100	1.787			6305A2-5/16	99,17
60	2-3/8	79,5	58	55	100	1.626	6305M60	110,56	6305A2-3/8	116,23
	2-7/16	82	58	55	100	1.715			6305A2-7/16	119,93
63		83,5	58	55	100	1.740	6305M63	113,76		
65		86	63	65	100	1.939	6305M65	113,76		

● VASOS INHEX

mm	D	ℓ	L	⚖	Ref	€
12	35	15,5	75	253	6012M12	21,48
14	35	15,5	75	265	6012M14	21,48
15	35	15,5	75	271	6012M15	21,48
16	35	15,5	75	285	6012M16	21,48
17	35	15,5	75	292	6012M17	21,48
18	35	15,5	75	302	6012M18	21,48
19	35	15,5	75	312	6012M19	21,48
20	35	15,5	75	323	6012M20	23,51
21	38	15,5	75	330	6012M21	23,51
22	38	22,5	75	340	6012M22	23,51
24	38	22,5	75	362	6012M24	23,51
27	38	22,5	75	402	6012M27	23,51
30	38	28,5	75	445	6012M30	49,78
32	38	28,5	75	485	6012M32	50,26
36	42	28,5	75	663	6012M36	50,26

LLAVE DE CARRACA REVERSIBLE

» 6749 / 6749-1000

Tipo	D	T	Dientes	L	⚖	€
6749	68	49,6	36	565	2.840	130,01
6749-1000	68	49,6	36	965	3.960	200,54

[Pack de repuestos **6749RK**]

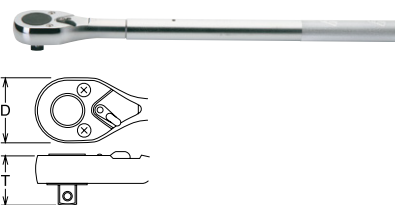

ALARGADERAS

» 6760

Ref	L	⚖	€
6760-75	75	335	19,15
6760-100	100	434	26,93
6760-125	125	528	29,49
6760-150	150	624	28,18
6760-200	200	815	28,18
6760-300	300	1.203	44,83
6760-400	400	1.585	44,83

-75/-100/-125/-150/-200/
-300/ -400



MANGO ARTICULADO

» 6768

Ref	L	⚖	€
6768	450	1.715	83,12

[Pack de repuestos **6768RK**]



MANGOS ARTICULADOS

» 6768-600/-1000

Ref	L	⚖	€
6768-600	600	2.360	108,00
6768-1000	1.000	2.480	149,14

[Pack de repuestos **6768RK**]



MANGO CORREDIZO

» 6785

Ref	L	⚖	€
6785	500	1.542	45,85



MANGO ACODADO

» 6788

Ref	L	⚖	€
6788	330	1.175	53,99



ARTICULACIÓN UNIVERSAL

» **6770**

Ref	L		€
6770	105	478	43,19

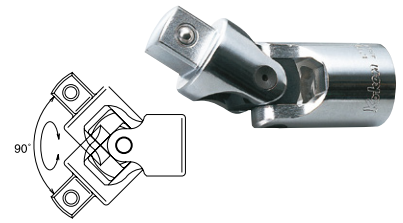

ADAPTADOR

» **6644A**

Ref	L		€
6644A	47	136	15,78

[Garantizado 668 Nm]

□3/4" x □1/2"



ADAPTADOR

» **6688A**

Ref	L		€
6688A	60	285	22,14

□3/4" x □1"



○ ○ **JUEGO DE VASOS**

» **6201M-00/-05** » **6201A-00/-05**

Ref				€
○ 6201M-00	580 x 200 x 85	16	17.300	676,17
○ 6201M-05	580 x 200 x 85	16	17.300	676,17

Vasos 6201M-00

6400M ○ 22, 24, 27, 30, 32, 36, 41, 46, 50, 55, 60

Vasos 6201M-05

6405M ○ 22, 24, 27, 30, 32, 36, 41, 46, 50, 55, 60

Accesorios

6749	
6760-200	
6760-400	
6768	
6785	



Ref				€
○ 6201A-00	580 x 200 x 85	16	17.300	689,12
○ 6201A-05	580 x 200 x 85	16	17.300	689,12

Vasos 6201A-00

6400A ○ 22, 24, 27, 30, 32, 36, 41, 46, 50, 55, 60

Vasos 6201A-05

6405A ○ 22, 24, 27, 30, 32, 36, 41, 46, 50, 55, 60

Accesorios

6749	
6760-200	
6760-400	
6768	
6785	

○ ○ **JUEGO DE VASOS**

» **6212M-00/-05**

Ref				€
○ 6212M-00	580 x 124 x 70	12	8.200	390,09
○ 6212M-05	580 x 124 x 70	12	8.200	390,09

Vasos 6212M-00

6400M ○ 22, 24, 27, 30, 32, 36, 41, 46, 50,

Vasos 6212M-05

6405M ○ 22, 24, 27, 30, 32, 36, 41, 46, 50,

Accesorios

6749	
6760-200	
6785	



○ VASOS HEXAGONALES

» 8400M » 8400A

mm	pulgadas	D1	D2	ℓ	L	⚖	Ref Métrica	€	Ref Pulgadas	€
24	15/16	36,5	44	17	60	348	8400M24	32,12	8400A15/16	33,62
27		40,5	44	19	60	362	8400M27	32,12		
28		41,5	44	19,5	60	368	8400M28	32,12		
29		43	44	20	60	378	8400M29	32,12		
30	1-3/16	44	45	21	65	410	8400M30	32,12	8400A1-3/16	33,62
32	1-1/4	46,5	45	23	65	455	8400M32	32,12	8400A1-1/4	33,62
33	1-5/16	48	46	23,5	65	485	8400M33	32,12	8400A1-5/16	33,62
34		49	46	24	65	500	8400M34	32,12		
35	1-3/8	50,5	48	24,5	65	536	8400M35	32,12	8400A1-3/8	33,62
36		51,5	48	25	65	600	8400M36	32,12		
	1-7/16	53	50	25,5	65	607			8400A1-7/16	33,62
38	1-1/2	54	50	26	65	624	8400M38	32,12	8400A1-1/2	33,62
40	1-9/16	56,5	53	27	65	686	8400M40	32,12	8400A1-9/16	33,62
41	1-5/8	58	53	28	68	747	8400M41	38,04	8400A1-5/8	38,04
42		59	53	28,5	68	789	8400M42	42,23		
	1-11/16	60,5	53	29	68	830			8400A1-11/16	44,56
	1-3/4	61,5	53	29,5	68	807			8400A1-3/4	44,56
46	1-13/16	64	53	31	72	928	8400M46	42,26	8400A1-13/16	44,56
	1-7/8	66,5	53	32	72	936			8400A1-7/8	48,95
	1-15/16	68	53	32,5	72	941			8400A1-15/16	48,95
50		69	53	34	72	943	8400M50	46,67		
	2	70,5	53	37	72	976			8400A2	48,95
	2-1/16	73	54	37	72	1027			8400A2-1/16	
54	2-1/8	74	55	37	72	1.016	8400M54	57,09	8400A2-1/8	60,33
55		75,5	53	42	77	1.167	8400M55	59,55		
56	2-3/16	76,5	53	42	77	1.160	8400M56	63,73	8400A2-3/16	62,81
	2-1/4	78	53	41	77	1.177			8400A2-1/4	67,38
58		79	53	41	77	1.200	8400M58	63,73		
	2-5/16	80,5	53	41	77	1.292			8400A2-5/16	67,38
60	2-3/8	81,5	58	46	82	1.440	8400M60	71,68	8400A2-3/8	75,39
	2-7/16	84	58	45	82	1.495			8400A2-7/16	75,39
63		85,5	58	45	82	1.470	8400M63	80,59		
	2-1/2	86,5	58	45	82	1.497			8400A2-1/2	88,72
65	2-9/16	88	63	49	86	1.683	8400M65	84,31	8400A2-9/16	88,72
67	2-5/8	90,5	63	49	86	1.840	8400M67	90,28	8400A2-5/8	95,19
68	2-11/16	91,5	63	49	86	1.800	8400M68	90,28	8400A2-11/16	95,19
70	2-3/4	94	68	50	88	1.963	8400M70	99,15	8400A2-3/4	104,56
71		95,5	68	50	88	2.200	8400M71	106,86		
	2-13/16	96,5	68	50	88	2.035			8400A2-13/16	112,55
	2-7/8	98	70	50	88	2.100			8400A2-7/8	112,54
75	2-15/16	100,5	73	53	90	2.204	8400M75	124,63	8400A 2-15/16	131,09
78	3	103	75	52,5	90	2.500	8400M78	132,05	8400A3	131,09
80	3-1/8	106,5	75	58	95	2.550	8400M80	132,05	8400A 3-1/8	138,94
83	3-1/4	110,5	78	57	95	2.730	8400M83	138,04	8400A 3-1/4	138,94
85		113	80	57	95	2.680	8400M85	138,04		
	3-3/8	114	80	57	95	3.050			8400A 3-3/8	218,59
90	3-1/2	119	80	59	100	3.420	8400M90	209,74	8400A 3-1/2	218,59
95	3-3/4	125,5	85	58	100	4.900	8400M95	244,27	8400A 3-3/4	256,68
100		131,5	85	57	100	4.840	8400M100	248,99		

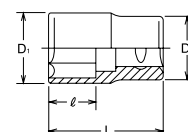

○ VASOS BIHEXAGONALES

» 8405M » 8405A

mm	pulgadas	D1	D2	ℓ	L	⚖	Ref Métrica	€	Ref Pulgadas	€
24	15/16	36,5	44	17	60	348	8405M24	32,12	8405A15/16	33,62
27		40,5	44	19	60	362	8405M27	32,12		
28		41,5	44	19,5	60	368	8405M28	32,12		
29		43	44	20	60	378	8405M29	32,12		
30	1-3/16	44	45	21	65	410	8405M30	32,12	8405A1-3/16	33,62
32	1-1/4	46,5	45	23	65	455	8405M32	32,12	8405A1-1/4	33,62
33	1-5/16	48	46	23,5	65	485	8405M33	32,12	8405A1-5/16	33,62
34		49	46	24	65	500	8405M34	32,12		
35	1-3/8	50,5	48	24,5	65	536	8405M35	32,12	8405A1-3/8	33,62
36		51,5	48	25	65	600	8405M36	32,12		
	1-7/16	53	50	25,5	65	607			8405A1-7/16	33,62
38	1-1/2	54	50	26	65	624	8405M38	32,12	8405A1-1/2	33,62
40	1-9/16	56,5	53	27	65	686	8405M40	32,12	8405A1-9/16	33,62
41	1-5/8	58	53	28	68	747	8405M41	38,04	8405A1-5/8	38,04
42		59	53	28,5	68	789	8405M42	42,23		
	1-11/16	60,5	53	29	68	830			8405A1-11/16	44,56
	1-3/4	61,5	53	29,5	68	807			8405A1-3/4	44,56
46	1-13/16	64	53	31	72	928	8405M46	42,26	8405A1-13/16	44,56
	1-7/8	66,5	53	32	72	936			8405A1-7/8	48,95
	1-15/16	68	53	32,5	72	941			8405A1-15/16	48,95
50		69	53	34	72	943	8405M50	46,67		
	2	70,5	53	37	72	976			8405A2	48,95
	2-1/16	73	54	37	72	1027			8405A2-1/16	48,95
54	2-1/8	74	55	37	72	1.016	8405M54	57,09	8405A2-1/8	60,33
55		75,5	53	42	77	1.167	8405M55	59,55		
56	2-3/16	76,5	53	42	77	1.160	8405M56	63,73	8405A2-3/16	62,81
	2-1/4	78	53	41	77	1.177			8405A2-1/4	67,38
58		79	53	41	77	1.200	8405M58	63,73		
	2-5/16	80,5	53	41	77	1.292			8405A2-5/16	67,38
60	2-3/8	81,5	58	46	82	1.440	8405M60	71,68	8405A2-3/8	75,39
	2-7/16	84	58	45	82	1.495			8405A2-7/16	75,39
63		85,5	58	45	82	1.470	8405M63	80,59		
	2-1/2	86,5	58	45	82	1.497			8405A2-1/2	88,72
65	2-9/16	88	63	49	86	1.683	8405M65	84,31	8405A2-9/16	88,72
67	2-5/8	90,5	63	49	86	1.840	8405M67	90,28	8405A2-5/8	95,19
68	2-11/16	91,5	63	49	86	1.800	8405M68	90,28	8405A2-11/16	95,19
70	2-3/4	94	68	50	88	1.963	8405M70	99,15	8405A2-3/4	104,56
71		95,5	68	50	88	2.200	8405M71	106,86		
	2-13/16	96,5	68	50	88	2.035			8405A2-13/16	112,55
	2-7/8	98	70	50	88	2.100			8405A2-7/8	112,54
75	2-15/16	100,5	73	53	90	2.204	8405M75	124,63	8405A 2-15/16	131,09
78	3	103	75	52,5	90	2.500	8405M78	132,05	8405A3	131,09
80	3-1/8	106,5	75	58	95	2.550	8405M80	132,05	8405A 3-1/8	138,94
83	3-1/4	110,5	78	57	95	2.730	8405M83	138,04	8405A 3-1/4	138,94
85		113	80	57	95	2.680	8405M85	138,04		
	3-3/8	114	80	57	95	3.050			8405A 3-3/8	218,59
90	3-1/2	119	80	59	100	3.420	8405M90	209,74	8405A 3-1/2	218,59
95	3-3/4	125,5	85	58	100	4.900	8405M95	244,27	8405A 3-3/4	256,68
100		131,5	85	57	100	4.840	8405M100	248,99		



KOKEN IIIIII

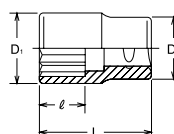

● VASOS INHEX

» 8012M-80

mm	D	ℓ	L	⚖	Ref	€
17	44,2	15,5	80	400	8012M17	55,19
19	44,2	15,5	80	410	8012M19	55,19
22	47,9	22,5	80	436	8012M22	55,19
24	47,9	22,5	80	471	8012M24	55,19
27	47,9	22,5	80	526	8012M27	55,19
30	47,9	22,5	80	658	8012M30	55,19
32	47,9	22,5	80	715	8012M32	56,81
36	54,2	22,5	80	945	8012M36	56,81

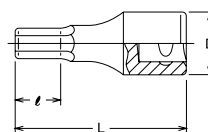

□ 1" LLAVES DE VASO

ALARGADERAS

Ref	L	⚖	€
8760-200	200	1.300	49,83
8760-400	400	2.570	75,00

» 8760-200/-400



ARTICULACIÓN UNIVERSAL

Ref	L	⚖	€
8770	143	1.170	99,17

» 8770

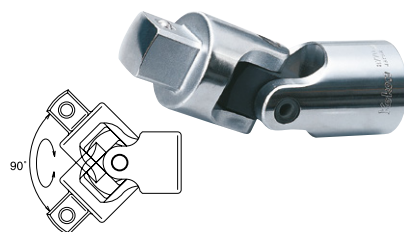

ADAPTADOR

Ref	L	⚖	€
8866A	60	338	21,98

» 8866A

[Garantizado 2130 Nm]

□1"x □3/4"



LLAVE DE CARRACA REVERSIBLE

Tipo	D	T	Dientes	L	⚖	€
8749	70	62,2	36	800	4.100	192,08

[Pack de repuestos 6749RK]

» 8749

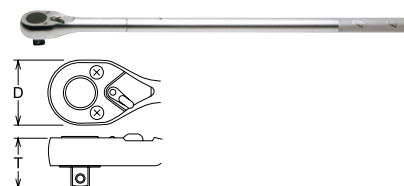

MANGO ARTICULADO

Ref	L	⚖	€
8768	600	2.590	168,29

[Pack de repuestos 8768RK]

» 8768



MANGO CORREDIZO

Ref	L	⚖	€
8785	550	3.190	103,02

» 8785



MANGO ACODADO

Ref	L	⚖	€
8788	600	3.600	122,21

» 8788



🏠 ○ ○ JUEGO DE VASOS

Ref	🏠	○	⚖	€
8225M-00	600 x 217 x 97	15	27.000	1.175,47
8225M-05	600 x 217 x 97	15	27.000	1.175,45

Vasos 8225M-00

8400M ○ 32, 33, 36, 41, 46, 50, 55, 60, 65, 70, 75, 80

Vasos 8225M-05

8405M ○ 32, 33, 36, 41, 46, 50, 55, 60, 65, 70, 75, 80

Accesorios

6749

6760-200

6760-400

» 8225M-00/-05

