



Para consultar las tarifas vigentes de los productos de este catálogo, enviar solicitud al email:
info@mtspain.net

MT FERMAT
®
FERRETERÍA & CONSTRUCCIÓN

CATÁLOGO/CATALOGUE

2021

ÍNDICE

INDEX

Introducción Introduction	01	Accesorio y válvulas de latón a compresión para tubo de cobre e inoxidable Brass compression fitting and valves for copper and stainless steel pipe	51
Novedades News	08	Accesorio de latón a compresión para tuberías PE Brass compression fitting for PE pipes	54
Válvulas Platinum Platinum series	20	Accesorio de compresión para tubería multicapa y PEX Compression fitting for multilayer and PEX pipe	56
Válvulas Gold Gold series	22	MT Garden	60
Válvulas Silver Silver series	25	Accesorio de hierro maleable galvanizado Malleable galvanized iron fitting	62
Grifos Bibcock range	27	Válvulas de acero inoxidable Stainless steel valves	68
Válvulas de escuadra Angle valves	29	Accesorio inoxidable roscado Stainless steel fitting threaded	70
Otras válvulas Other valves	31	Abarcones U-bolts	75
Accesorio de latón roscado Brass threaded fitting	36	Manómetros Pressure gauges	76
Boyas de latón Brass float guide	43	Varios Others	77
Accesorio de latón roscado cromado Chrome plated brass threaded fitting	44	Conexiones flexibles Flexible connections	86
Accesorio de latón para tubería de cobre Brass fitting for copper pipe	47	Condiciones de venta Sales conditions	88
Accesorio de latón para tubo de hierro Brass compression fitting for iron pipe	50		
Índice de referencias References index			90



MT es una multinacional española que fabrica y comercializa productos y accesorios para la canalización y conducción de fluidos en más de 40 países.

MT is an spanish company that manufactures and distributes products and accessories for the canalization and conduction of fluids in more than 40 countries.

Desde 1994, MT diseña, produce y comercializa una amplia gama de productos para el segmento hidrosanitario e industrial entre los que destacan los accesorios y las válvulas de latón, accesorios de acero inoxidable, bridas y válvulas industriales, entre otros.

Since 1994, MT has been designing, producing and marketing a wide range of products for the hydrosanitary and industrial segment, including brass valves and fittings, stainless steel fittings, flanges and industrial valves, among others.

La compañía basa su estrategia en la satisfacción del cliente con una excelente relación calidad precio en más de 4.000 referencias especialmente producidas para el profesional distribuidor.

The aim of the company is the customer satisfaction, trying to give the best quality – price combination in more than 4,000 references, specially made for the professional distributor.

Con una alta cuota de mercado, MT se posiciona como una de las empresas más completas en soluciones integrales para la conducción de fluidos, segmento clave para el sector industrial, tratamientos de agua y riego, usos hidrosanitarios, automatización, instrumentación, etc.

With a nice market presence, MT is positioned as one of the most complete companies in integral solutions for the conduction of fluids, key segment for the industrial sector, water and irrigation treatments, hydrosanitary uses, automation, instrumentation, etc.

Actualmente, MT cuenta con una red de distribuidores propios en más de 12 países, una filial en México (MT América), y clientes en 40 países de 4 continentes.

Nowadays, MT has a network of its own distributors in more than 12 countries, a subsidiary in Mexico (MT America) and clients in 40 countries on 4 continents.



PRODUCTOS PRODUCTS

Todas las referencias de MT las encontrarás bajo dos grandes divisiones: Hidro e Industrial, con las que la compañía quiere dar una respuesta específica según el ámbito para el que se han diseñado.

MT portfolio of products are braced in two major divisions: Hydro and Industrial, and with those two divisions we try to give the specific solution on each situation.



MT[®] HIDRO

La división Hidro MT agrupa todos los productos específicamente diseñados para la canalización y conducción de fluidos para los sectores de construcción, fontanería, riego y jardín.

Se trata de una amplia gama de productos en la que encontraremos accesorios de hierro maleable galvanizado, válvulas de latón y accesorios de latón, reductoras de presión, válvulas de PVC, válvulas y descargas para WC, manómetros, y una selección de los productos más importantes de MAC3, fabricante mundial de productos electrónicos para sistemas hidráulicos.

The Hidro MT division contains all the products, specifically designed for the canalization and conduction of fluids for the construction, plumbing, irrigation and gardening sectors.

It is a wide range of products in which we find malleable galvanized iron fittings, brass valves and brass fittings, pressure reducers, PVC valves, WC valves and discharges, manometers and a selection of the most important products of MAC3, an Italian manufacturer of electronic products for hydraulic systems.

La división Industrial ofrece piezas de gran calidad de acero inoxidable específicamente pensados para el ámbito industrial. Toda la gama está fabricada bajo estrictos parámetros de calidad cumpliendo con las más altas certificaciones en conducción de fluidos.

Se trata de una amplia gama de productos inox con referencias de bridas y valonas de acero inoxidable, accesorio roscado de acero inoxidable, accesorios para la soldadura de tubo inoxidable, MT Press para prensar, válvulas inoxidables, válvulas de fundición y automatismos.

The Industrial division offers high quality stainless steel parts specifically designed for the industrial sector. The entire range is manufactured under strict quality parameters that comply with the highest certifications in conducting fluids.

It is a wide range of stainless steel products including stainless steel flanges, threaded fittings, welding accessories, MT press fitting, valves, casting valves, ductile valves and automatismos.

MT[®] INDUSTRIAL





CERTIFICADOS DE EMPRESA

COMPANY CERTIFICATIONS

Desde su creación, MT ha apostado por fijar objetivos de calidad e innovación sobre los que construir productos eficientes, seguros, duraderos y altamente rentables. La compañía permanece totalmente alineada con la legislación Europea, cada vez más estricta en sus políticas medioambientales, seguridad e higiene, y apuesta por el desarrollo continuo de nuevas líneas de producción. MT es hoy referente en calidad y homologaciones.

Since its inception, MT has focused its efforts on establishing quality and innovation objectives to build efficient, safe, durable and highly profitable products. The company remains fully aligned with European legislation, keeping ourselves strict in its policies on environment, safety and hygiene, and is committed to the continuous development of new production lines. MT is now a benchmark in quality and approvals.

Certificado TÜV para la Gestión de la Calidad

La organización demuestra su capacidad para proporcionar de forma coherente productos o servicios que satisfacen los requisitos del cliente y los reglamentos aplicables según la norma UNE-EN ISO 9001.

TÜV Quality Management Certificate

The organization demonstrates its ability to consistently deliver products or services that meet customer and regulatory requirements applicable to UNE-EN ISO 9001.

CERTIFICADOS DE PRODUCTO

PRODUCT CERTIFICATIONS



La Asociación alemana del sector de gas y agua (DVGW) certifica, entre otros, materiales de sellado para el abastecimiento de gas en Alemania.

The German Association of the Gas and Water Industry (DVGW) certifies, among other things, sealing materials for gas supply in Germany.



Certificación para el empleo de materiales de juntas de sellado con agua potable de acuerdo con la norma británica BS 6920.

Certification for the use of sealing gasket materials with drinking water in accordance with British Standard BS 6920.



Autorización oficial expedida por la Dirección General Sanitaria francesa desde 1998. Se aplica a los materiales constitutivos de los equipos que están en contacto con el agua destinada al consumo humano así como a los equipos en sí.

Official authorization issued by the General Directorate of Health since 1998 (ACS certification). It is applied to equipment constituting materials that are in contact with water intended for human consumption, as well as to the equipment itself.



Autorización oficial expedida por Le Centre Scientifique et Technique du Bâtiment (CSTB).

Official authorization issued by the Center Scientifique et Technique du Bâtiment (CSTB).



Certificación de sistemas de tubería multicapa para instalaciones de agua potable (caliente y fría) en edificación de acuerdo con la normativa EN ISO 21003.

Certification of multilayer piping systems for hot and cold drinking water inside buildings in accordance with EN ISO 21003.



Certificado de sistema tubería PE-X para instalaciones de agua caliente y fría en instalaciones de agua sanitaria y calefacción de acuerdo a normativa UNE-EN ISO 15875 y BRL 5606.

Certification of PE-X piping systems for hot and cold drinking water and heating installations in accordance with UNE-EN ISO 15875 and BRL 5606.



Certificación conforme el producto cumple con la normativa UNE-EN 13828 (diseño) y la NKB-13 (migración metales pesados).

Certification according the product complies with UNE-EN 13828 (design) and NKB-13 (heavy metal migration).



Certificación oficial expedida por el Instituto Nacional de Sanidad Pública de Polonia. Se aplica a los materiales constitutivos de los equipos que están en contacto con el agua destinada al consumo humano.

Official certificate issued by the National Institute of Public Hygiene of Poland. It is applied to equipment constituting materials that are in contact with water intended for human consumption.



Certificación de conformidad para los productos que cumplen con todos los reglamentos técnicos de la Unión Aduanera Euroasiática.

Product compliance Certificate according to the technical regulations of the Eurasian Custom Union.



Certificación de conformidad de válvulas para trabajo en atmósferas explosivas y/o inflamables.

Certification of conformity of valves for work in explosive and/or flammable atmospheres.

MT® VALOR DIFERENCIAL
VALVES AND FITTINGS DIFERENTIAL VALUE

MT se ha posicionado en el mercado como una de las empresas más ágiles en capacidad de respuesta, relación calidad-precio y catálogo de referencias.

La compañía ha definido una estrategia comercial basada en precios competitivos y una máxima preocupación: no sobre-estocar al cliente. Esto nos permite ajustar la producción a las necesidades reales del mercado y sus profesionales y ofrecer:

MT has positioned itself in the market as one of the most agile companies in terms of responsiveness, value for money and reference catalog.

The company has defined its commercial strategy based on competitive prices and a maximum concern: not over-store the customer. This allows us to adjust production to the real needs of the market and its professionals and offer:



MT ha consolidado una red de distribución internacional, entendiendo las especificidades que marca cada mercado y adaptando certificaciones y requerimientos de cada país.

El modelo logístico pone el foco en la anticipación y la capacidad de respuesta en un amplio catálogo de productos. Esto es posible, entre otros, gracias al código EAN incorporado en cada uno de sus productos, imprescindible para un óptimo control de los stocks y la venta de productos por línea de caja.

MT has consolidated an international distribution network, understanding the specificities that mark each market and adapting the certifications and requirements of each country.

The logistic model puts the focus on anticipation and responsiveness in a wide product catalog. This is possible, among others, thanks to the EAN code incorporated in each of its products, essential for optimum control of stocks and the sale of products on counters.



Nuevo servicio urgente 24h.
New urgent service 24h.



Amplio catálogo de productos con más de 4.000 referencias
Wide catalog of products with more than 4.000 references



Producción homologada según normativas y certificaciones
Production approved according to regulations and certifications

Condiciones válidas sólo en España
Valid conditions only in Spain

Consultar condiciones de venta página 268
See sales conditions on page 268



Servicio logístico que vela por el no sobre-estocaje del cliente
Logistic service that monitors non-storage



Atención al cliente basada en la inmediatez y la flexibilidad
Customer support based on immediacy and flexibility

PACK DE DATOS PARA VENTA ONLINE

DATA PACK FOR ECOMMERCE

MT dispone de software específico para la gestión y optimización de toda la información referente a nuestros productos. Hemos digitalizado nuestra base de datos con las especificaciones técnicas de nuestro catálogo.

Ofrecemos paquetes de datos online estandarizados, preparados para la implementación sobre las plataformas ecommerce de nuestros clientes.

De esta manera podemos suministrar documentación actualizada, de manera rápida y optimizada, según los requerimientos del nuevo mercado digital.

MT has specific software for the management and optimization of all the information regarding our products. We have digitized our database with the technical specifications of the catalogue.

We offer standard online data packages, ready to be implemented on our customers' ecommerce platforms.

In this way we can provide up-to-date documentation, quickly and optimized, according to the requirements of the new digital market.



NOVEDADES NEWS

Cajas dispensadoras completamente personalizables, blisters y embolsados. Todo para facilitar su correcta identificación y clasificación.

Dispenser boxes completely customizable, blister packs and bagged. All to facilitate its correct identification and classification.





SOLUCIONES DE MARKETING A MEDIDA

CUSTOMIZED MARKETING SOLUTIONS

Dos factores determinan los resultados en el punto de venta: visibilidad y notoriedad. Ser capaces de llamar la atención del consumidor y transmitir el concepto y las principales ventajas técnicas del producto es otro de nuestros máximos objetivos.

MT pone a disposición de sus clientes un completo abanico de soluciones orientadas a reforzar sus acciones comerciales en el punto de venta con un fin: reforzar la identidad corporativa de los productos ofertados y facilitar al máximo la venta.

- Acciones de marketing promocional
- Comunicación retail
- Productos dotados de herramientas comerciales especialmente creadas: expositor, bolsas, etiquetas, categorías, muestras, etc.

There are two factors that determine the results in point of sale: visibility and notoriety. Be able to attract attention of customers and transmit the concept and the main technical advantages of our products is other of our main goals.

MT makes available to the customers a complete variety of solutions oriented to reinforce his point of sale commercial actions with a goal: reinforce the corporate identity of the quoted products and facilitate at maximum the sale..

- Promotional marketing actions
- Retail communication
- Products equipped with commercial tools specially designed for them: exhibitor, bags, labels, categories, samples, etc.

NUESTRAS HERRAMIENTAS COMERCIALES

- Implantaciones por familias de productos.
- Cajas dispensadoras etiquetadas para estanterías modulares.
- Expositores para válvulas de llenado y descarga.
- Box pallet para punto de venta.

OUR COMMERCIAL TOOLS

- Establishments by product families.
- Dispenser boxes labeled for modular shelves.
- Exhibitors for flush and fill valves.
- Box pallet for point of sale.





Box palet personalizable para punto de venta.
Customizable box pallet for point of sale.



Expositores para la familia de válvulas de llenado y descarga de wc.
Expositors for our Flush & fill valves range.

IMPLANTACIONES POR FAMILIAS DE PRODUCTOS



Estas implantaciones se han diseñado en base a un estudio de mercado realizado a nivel nacional, con las referencias de más rotación. El cliente puede modificar o cambiar cualquier artículo por las necesidades de su zona o tipología de mercado al que va dirigido el producto.

These implementations have been designed based on the market development, choosing the references with high rotation. The customer can modify the item shown according to the needs of their area or market.

CÓDIGOS EAN

EAN CODES

Para un mayor control de los stocks, eliminando posibles errores en los precios, para la solicitud de pedidos con un código único y compatible con el programa de gestión internacional EDI.

For better stock control, in order to avoid possible mistakes in prices, for the request of orders with a unique code and compatible with the international management program EDI.

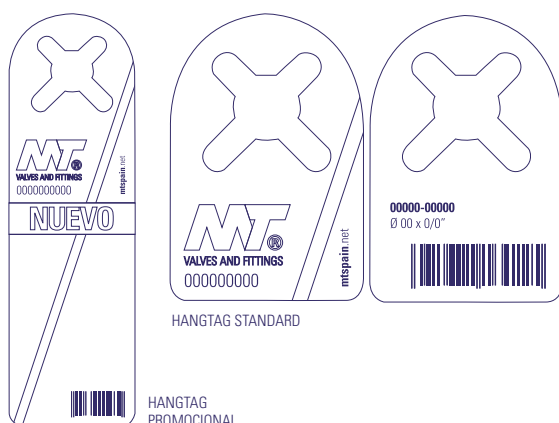
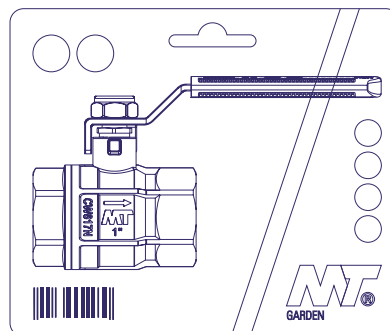

HANGTAGS

HANGTAGS

Etiqueta individual por artículo, donde se facilita la información de la referencia del producto, certificaciones, medidas y código EAN 13.

Every article comes individually labeled, and this label comes with the product reference information, certifications, measurements and EAN 13 code

pag. **MT®**
21

NUEVA PN40 ANTI-CAL EN LATÓN NIQUELADO

NEW ANTI-LIME NICKEL-PLATED BRASS
PN40 VALVE



ESFERA DE ACERO
INOXIDABLE CON
RECUBRIMIENTO PTFE

STAINLESS STEEL BALL
WITH PTFE COATING

PLATINUM
SERIES

**PN
40**



ANTI-HIELO
NO FROST



ANTICAL
ANTI-LIME

NUEVA VÁLVULA ESFERA ANTICAL PN-40
H-H PASO TOTAL LATÓN NIQUELADO CON
PALANCA INOXIDABLE ERGONÓMICA COLOR
VERDE

NEW ANTI-LIME BALL VALVE PN-40 F-F FULL
BORE NICKEL-PLATED BRASS WITH GREEN
ERGONOMIC STAINLESS STEEL HANDLE



SERIE 87 NUEVAS REFERENCIAS

87 SERIES
NEW REFERENCES



87093

CODO 90° M-M
M-M ELBOW 90°



87098

CODO 90° M-H CON CONECTOR 2 PIEZAS
M-F ELBOW 90° WITH 2 PIECES CONNECTOR



87132

TE IGUAL MACHO
M EQUAL TEE



87500

RACOR CODO MURAL H-H
F-F WALL PLATED ELBOW



87575

ANILLO REDUCIDO H-M
REDUCING RING F-M



ACCESORIO DE LATÓN ROSCADO CROMADO

CHROME PLATED BRASS THREADED FITTING

PRESIÓN MÁXIMA DE TRABAJO
MAXIMUM WORKING PRESSURE

 25 BAR



CARACTERÍSTICAS GENERALES
GENERAL FEATURES

Estampado en caliente
Hot forged

Cuerpo en latón cromado
Chromed-plated brass body

Rosca macho paralela / Rosca hembra paralela
Parallel male thread / Parallel female thread



Ref. 871090
Codo 90° H-H
F-F Elbow 90°



Ref. 871092
Codo 90° M-H
M-F Elbow 90°



Ref. 871500
Racor codo mural
Wall plated elbow



Ref. 871130
Te igual H
F Equal tee



Ref. 871240
Manguito reducción H-H
F-F Reducing socket



Ref. 871241
Tuerca reducción M-H
M-F reducing bushings



Ref. 871245
Machón reducido M-M
M-M Reducing nipple



Ref. 871246
Manguito reducción M-H
M-F Reducing nipple socket



Ref. 871270
Manguito H-H
F-F socket



Ref. 871280
Machón M-M
M-M hexagon nipple



Ref. 871290
Tapón con reborde M
M plug beaded



Ref. 871300
Tapón hexagonal H
F hexagon cap



Ref. 871529
Manguito igual M-H
"tipo marsella"
M-F equal socket
'marsella type'



Ref. 87534
Alargadera M-H (hex. interior)
M-F extension fitting (hexagon inside)



Ref. 871531
Manguito igual M-H
(hexágono interior)
M-F Equal socket
(hexagon inside)



STOP FLOW

STOP FLOW

BY hydrelis

TRANQUILIDAD, DONDE QUIERA QUE ESTÉS

COMPOSURE, WHEREVER YOU ARE



CIERRA EL SUMINISTRO DE AGUA
EN CASO DE DETECCIÓN DE FUGAS
SHUT OFF THE WATER SUPPLY
IN CASE OF LEAK DETECTION



FÁCIL INSTALACIÓN
EASY INSTALLATION



BATERÍA DE LITIO
8 AÑOS DE DURACIÓN
LITHIUM BATTERY
8 YEAR DURATION



FÁCIL GESTIÓN GRACIAS
A SU PANEL DE CONTROL
ENERGY MANAGEMENT
TO YOUR CONTROL PANEL



- En caso de fuga o rotura de una tubería, la válvula cierra el suministro de agua y se envía una notificación inmediata.
- El agua se restablece simplemente pulsando el botón "ON" sobre la carcasa de la válvula.

- When a pipeline leak or break, the valve shuts off the water supply and immediate notification is sent.
- Water is restored simply by pressing the "ON" button on housing valve.

- Desde la aplicación, cierre el agua de su casa a distancia en tiempo real.
- Puede supervisar su consumo de agua (por mes, por semana, por día o por hora) y hacer un seguimiento de su ahorro.

- From the application, turn off the water in your home remotely in real time.
- You can monitor your water consumption (by month, by week, by day or by hour) and keep track of your savings.

- Capacidad de monitorear/administrar múltiples sitios desde un portal web.
- Una aplicación eficiente y fácil de usar disponible de forma gratuita en iOS y Android.

- Ability to monitor/manage multiple sites from a web portal.
- An efficient and easy application free available on iOS and Android.



NUEVOS FILTROS MAGNÉTICOS

NEW MAGNETIC FILTERS

4156

EL FILTRO MAGNÉTICO ELIMINA LAS IMPUREZAS DE LOS CIRCUITOS. EL IMÁN QUE INCORPORA RETIENE LAS IMPUREZAS FÉRRICAS.

MAGNETIC STRAINER REMOVES IMPURITIES FROM THE CIRCUITS. THE INCORPORATING MAG NET RETAINS THE IRON IMPURITIES.

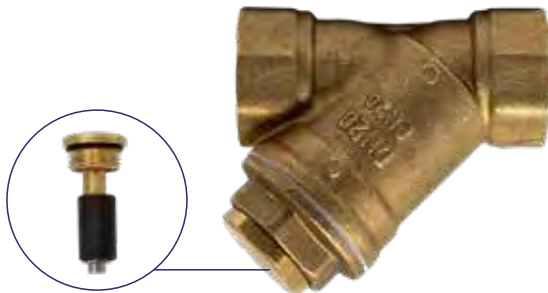

- Tamiz filtrante de 1000 micras (1mm)
Filter sieve 1000 microns (1mm)
- Imán extraíble de 4.000 Gauss
4.000 Gauss removable magnet
- Roscas hembra según ISO 228
Female threads according to ISO 228
- Fácil desmontaje del tamiz para su limpieza con junta de PTFE
Easy disassembly of the sieve for cleaning with PTFE gasket.
- Presión máxima de trabajo: 10 Bar
Max. working pressure: 10 Bar
- Temperatura de funcionamiento de 130°C
Operating temperature of 130°C

Apto para instalaciones de calefacción con calderas de gas, gasoil y biomasa. Instalaciones de calor y frío con bomba de calor de aérotermia y geotermia. Instalaciones de agua y agua con glicol. Instalaciones de suministro de agua.

Suitable for heating installations with gas, diesel and biomass boilers. Heat and cold installations with aérothermal and geothermal heat pump. Water and water installations with glycol. Water supply facilities.

4157

EL FILTRO DESFANGADOR MAGNÉTICO SEPARA Y ELIMINA LAS IMPUREZAS DE LOS CIRCUITOS CERRADOS. EL IMÁN QUE INCORPORA RETIENE LAS IMPUREZAS FÉRRICAS.

MAGNETIC DIRT SEPARATOR STRAINER SEPARATES AND REMOVES IMPURITIES FROM CLOSED CIRCUITS. THE INCORPORATING MAGNET RETAINS THE IRON IMPURITIES.



- Tamiz filtrante de 800 micras (0.8mm)
Filter sieve 800 microns (0.8mm)
- Imán extraíble de 12.000 Gauss
12.000 Gauss removable magnet
- Válvula M-H de 3/4", enlace 3/4" (racor loco) y tapón 3/4" en latón
M "M-H valve, 3/4" link (crazy fitting) and brass 3/4" plug
- Roscas hembra según ISO 228
Female threads according to ISO 228
- Fácil desmontaje del tamiz para su limpieza con junta de PTFE
Easy disassembly of the sieve for cleaning with PTFE gasket.
- Presión máxima de trabajo: 10 Bar
Max. working pressure: 10 Bar
- Temperatura de funcionamiento de 110°C
Operating temperature of 110°C
- Ideal para instalación en lugares con limitaciones de espacio.
Ideal for installation in places with space limitations.
- Con la instalación de una válvula en el tapón se puede limpiar las impurezas del desfangador sin parar el circuito.
With the installation of a valve in the cap, the impurities of the defroster can be cleaned without stopping the circuit.

Apto para instalaciones de calefacción con calderas de gas, gasoil y biomasa. Instalaciones de calor y frío con bomba de calor de aérotermia y geotermia. Instalaciones de agua y agua con glicol.

Suitable for heating installations with gas, diesel and biomass boilers. Heat and cold installations with aérothermal and geothermal heat pump. Water and water installations with glycol.

pag. **MT®**
43

VÁLVULAS DE FLOTADOR Y BOYAS

FLOAT VALVES AND BUOYS

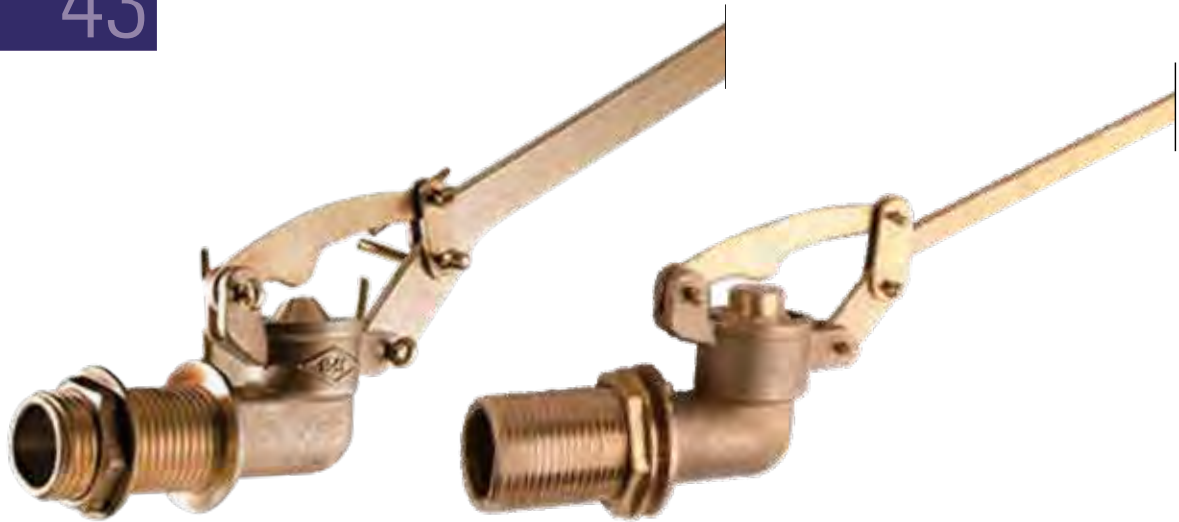

pag. **MT®**
82

FLEXO DE DUCHA

FLEXIBLE DE PVC

FLEXIBLE PVC SHOWER HOSE





CONEXIÓN FLEXIBLE "LATIGUILLO" FLEXIBLE CONNECTION



LIMPIADOR PARA POLIETILENO POLYETHYLENE CLEANER



PLATINUM SERIES

PN40

VÁLVULA DE BOLA
BALL VALVE

ANTI CORROSIÓN ANTIHIELO
ANTI RUST NOFROST



LEYENDA DE ICONOS ICON KEY

Posibles codificaciones aplicadas en esta sección.

Possible encodings applied in this section.



CERTIFICADOS DE PRODUCTO
PRODUCT CERTIFICATES

DZR *
Latón DZR DZR Brass
Antihielo Nofrost system

PROPIEDADES DE PRODUCTO
PRODUCT PROPERTIES

VÁLVULA ESFERA PN-40 H-H PASO TOTAL EN LATÓN DZR PALANCA ERGONÓMICA COLOR NEGRO ACERO INOXIDABLE F-F DZR BRASS BALL VALVE PN-40 FULL BORE WITH BLACK ERGONOMIC STAINLESS STEEL HANDLE

PLATINUM *

ACS SINTEF

4104



CÓDIGO CODE	MEDIDA SIZE		CÓDIGO EAN EAN CODE
4104-015	1/2"	48 12	8435319113950
4104-020	3/4"	32 8	8435319113967
4104-025	1"	20 5	8435319113974
4104-032	1 1/4"	12 3	8435319113981
4104-040	1 1/2"	12 2	8435319113998
4104-050	2"	12 2	8435319114001

- Recambio maneta disponible
Spare part handle available

VÁLVULA ESFERA PN-40 M-H PASO TOTAL EN LATÓN DZR PALANCA ERGONÓMICA COLOR NEGRO ACERO INOXIDABLE M-F DZR BRASS BALL VALVE PN-40 FULL BORE WITH BLACK ERGONOMIC STAINLESS STEEL HANDLE

PLATINUM *

ACS SINTEF

4504



CÓDIGO CODE	MEDIDA SIZE		CÓDIGO EAN EAN CODE
4504-015	1/2"	40 10	8435319115831
4504-020	3/4"	24 6	8435319115848
4504-025	1"	16 4	8435319115855
4504-032	1 1/4"	12 3	8435319115862
4504-040	1 1/2"	12 2	8435319115879
4504-050	2"	12 1	8435319115886

- Recambio maneta disponible
Spare part handle available

VÁLVULA ESFERA PN-40 H-H PASO TOTAL EN LATÓN DZR MANDO PALOMILLA COLOR NEGRO F-F DZR BRASS BALL VALVE PN-40 FULL BORE WITH BLACK BUTTERFLY HANDLE

PLATINUM *

ACS SINTEF

4204



CÓDIGO CODE	MEDIDA SIZE		CÓDIGO EAN EAN CODE
4204-015	1/2"	60 15	8435319145357
4204-020	3/4"	44 11	8435319145364
4204-025	1"	28 7	8435319145371

VÁLVULA ESFERA PN-40 H-H PASO TOTAL EN LATÓN DZR MANDO PALOMILLA COLOR NEGRO F-F DZR BRASS BALL VALVE PN-40 FULL BORE WITH BLACK BUTTERFLY HANDLE

PLATINUM *

ACS SINTEF

4604



CÓDIGO CODE	MEDIDA SIZE		CÓDIGO EAN EAN CODE
4604-015	1/2"	60 15	8435319145388
4604-020	3/4"	44 11	8435319145395
4604-025	1"	28 7	8435319145401

VÁLVULA ESFERA ANTI-CAL PN-40 H-H
PASO TOTAL LATÓN NIQUELADO C/
PALANCA INOX. ERGONÓMICA COLOR
VERDE BALL VALVE PN-40 F-F FULL BORE
NICKEL-PLATED BRASS WITH GREEN
ERGONOMIC S.S. HANDLE



PLATINUM 



4304

NEW



CÓDIGO	MEDIDA			CÓDIGO EAN
CODE	SIZE			EAN CODE
4304-015	1/2"	48	12	8435319149454
4304-020	3/4"	32	8	8435319149461
4304-025	1"	20	5	8435319149478
4304-032	1 1/4"	12	3	8435319149485
4304-040	1 1/2"	12	2	8435319149492
4304-050	2"	12	2	8435319149508

- Esfera inoxidable con recubrimiento PTFE
Stainless steel ball with PTFE coating

GOLD SERIES



PN30

VÁLVULA DE BOLA
BALL VALVE

ANTIHIELO
NOFROST

LEYENDA DE ICONOS ICON KEY

Posibles codificaciones aplicadas en esta sección.

Possible encodings applied in this section.



CERTIFICADOS DE PRODUCTO
PRODUCT CERTIFICATES



Antihielo
Nofrost
system

PROPIEDADES DE PRODUCTO
PRODUCT PROPERTIES

VÁLVULA ESFERA PN-30 H-H PASO
TOTAL PALANCA ERGONÓMICA COLOR
ROJO ACERO INOXIDABLE F-F BRASS
BALL VALVE PN-30 FULL BORE RED
ERGONOMIC STAINLESS STEEL HANDLE

GOLD

WRAS ACS PZH

4295



CÓDIGO CODE	MEDIDA SIZE			CÓDIGO EAN EAN CODE
4295-008	1/4"	72	12	8435319143537
4295-010	3/8"	72	12	8435319143544
4295-015	1/2"	54	9	8435319143551
4295-020	3/4"	36	9	8435319143568
4295-025	1"	24	6	8435319143575
4295-032	1 1/4"	16	4	8435319143582
4295-040	1 1/2"	8	2	8435319143599
4295-050	2"	12	2	8435319143605
4295-065	2 1/2"	6	1	8435319143612
4295-080	3"	4	1	8435319143629
4295-100	4"	2	1	8435319143636

- Recambio maneta disponible
Spare part handle available

VÁLVULA ESFERA PN-30 H-H PASO
TOTAL PALANCA ERGONÓMICA COLOR
AZUL ACERO INOXIDABLE F-F BRASS
BALL VALVE PN-30 FULL BORE BLUE
ERGONOMIC STAINLESS STEEL HANDLE

GOLD

WRAS ACS PZH

42952



CÓDIGO CODE	MEDIDA SIZE			CÓDIGO EAN EAN CODE
42952-008	1/4"	72	12	8435319143643
42952-010	3/8"	72	12	8435319143650
42952-015	1/2"	54	9	8435319143667
42952-020	3/4"	36	9	8435319143674
42952-025	1"	24	6	8435319143681
42952-032	1 1/4"	16	4	8435319143698
42952-040	1 1/2"	8	2	8435319143704
42952-050	2"	12	2	8435319143711
42952-065	2 1/2"	6	1	8435319143728
42952-080	3"	4	1	8435319143735
42952-100	4"	2	1	8435319143742

- Recambio maneta disponible
Spare part handle available

VÁLVULA ESFERA PN-30 M-H PASO
TOTAL PALANCA ERGONÓMICA COLOR
ROJO ACERO INOXIDABLE M-F BRASS
BALL VALVE PN-30 FULL BORE RED
ERGONOMIC STAINLESS STEEL HANDLE

GOLD

WRAS ACS PZH

4097



CÓDIGO CODE	MEDIDA SIZE			CÓDIGO EAN EAN CODE
4097-010	3/8"	72	12	8435319113509
4097-015	1/2"	54	9	8435319113516
4097-020	3/4"	36	9	8435319113530
4097-025	1"	24	6	8435319113554
4097-032	1 1/4"	16	4	8435319113578
4097-040	1 1/2"	8	2	8435319113592
4097-050	2"	12	2	8435319113615

- Recambio maneta disponible
Spare part handle available

VÁLVULA ESFERA PN-30 M-H PASO
TOTAL PALANCA ERGONÓMICA COLOR
AZUL ACERO INOXIDABLE M-F BRASS
BALL VALVE PN-30 FULL BORE BLUE
ERGONOMIC STAINLESS STEEL HANDLE

GOLD

WRAS ACS PZH

40972



CÓDIGO CODE	MEDIDA SIZE			CÓDIGO EAN EAN CODE
40972-010	3/8"	72	12	8435319143759
40972-015	1/2"	54	9	8435319143766
40972-020	3/4"	36	9	8435319143773
40972-025	1"	24	6	8435319143780
40972-032	1 1/4"	16	4	8435319143797
40972-040	1 1/2"	8	2	8435319143803
40972-050	2"	12	2	8435319143810

- Recambio maneta disponible
Spare part handle available



VÁLVULA ESFERA PN-30 M-M PASO
TOTAL PALANCA ERGONÓMICA COLOR
ROJO ACERO INOXIDABLE M-M BRASS
BALL VALVE PN-30 FULL BORE RED
ERGONOMIC STAINLESS STEEL HANDLE

GOLD 

WRAS ACS PZH

4098



CÓDIGO CODE	MEDIDA SIZE			CÓDIGO EAN EAN CODE
4098-015	1/2"	48	12	8435319113646
4098-020	3/4"	36	9	8435319113653
4098-025	1"	24	6	8435319113660
4098-032	1 1/4"	12	3	8435319113677
4098-040	1 1/2"	12	2	8435319113684
4098-050	2"	12	2	8435319113691

- Recambio maneta disponible
Spare part handle available



VÁLVULA ESFERA PN-30 M-M PASO
TOTAL PALANCA ERGONÓMICA COLOR
AZUL ACERO INOXIDABLE M-M BRASS
BALL VALVE PN-30 FULL BORE BLUE
ERGONOMIC STAINLESS STEEL HANDLE

GOLD 

WRAS ACS PZH

40982



CÓDIGO CODE	MEDIDA SIZE			CÓDIGO EAN EAN CODE
40982-015	1/2"	48	12	8435319143834
40982-020	3/4"	36	9	8435319143841
40982-025	1"	24	6	8435319143858
40982-032	1 1/4"	12	3	8435319143865
40982-040	1 1/2"	12	2	8435319143872
40982-050	2"	12	2	8435319143889

- Recambio maneta disponible
Spare part handle available



VÁLVULA ESFERA DOS PIEZAS PN-30
M-H MANDO PALOMILLA COLOR AZUL
M-F BALL VALVE PN-30 WITH TWO PIEC-
ES CONNECTOR AND BLUE BUTTERFLY
HANDLE

GOLD 

WRAS ACS PZH

4106



CÓDIGO CODE	MEDIDA SIZE			CÓDIGO EAN EAN CODE
4106-015	1/2"	54	9	8435319114070
4106-020	3/4"	36	9	8435319114087
4106-025	1"	24	6	8435319114094
4106-032*	1 1/4"	8	2	8435319114100
4106-040*	1 1/2"	12	2	8435319146095
4106-050*	2"	6	1	8435319146101

- * Solo disponible en palanca con acero inoxidable
* Only available with stainless steel handle



VÁLVULA ESFERA DOS PIEZAS PN-30
M-H MANDO PALOMILLA COLOR ROJO
M-F BALL VALVE PN-30 WITH TWO PIEC-
ES CONNECTOR AND RED BUTTERFLY
HANDLE

GOLD 

WRAS ACS PZH

41062



CÓDIGO CODE	MEDIDA SIZE			CÓDIGO EAN EAN CODE
41062-015	1/2"	54	9	8435319128411
41062-020	3/4"	36	9	8435319128428
41062-025	1"	24	6	8435319128435



VÁLVULA ESFERA PN-30 H-H PASO
TOTAL MANDO PALOMILLA COLOR ROJO
F-F BRASS BALL VALVE PN-30 FULL BORE
WITH RED BUTTERFLY HANDLE

GOLD 

WRAS ACS PZH

4102



CÓDIGO CODE	MEDIDA SIZE			CÓDIGO EAN EAN CODE
4102-010	3/8"	72	12	8435319113820
4102-015	1/2"	60	10	8435319113844
4102-020	3/4"	36	9	8435319113851
4102-025	1"	24	6	8435319113868



VÁLVULA ESFERA PN-30 H-H PASO
TOTAL MANDO PALOMILLA COLOR AZUL
F-F BRASS BALL VALVE PN-30 FULL BORE
WITH BLUE BUTTERFLY HANDLE

GOLD 

WRAS ACS PZH

41022



CÓDIGO CODE	MEDIDA SIZE			CÓDIGO EAN EAN CODE
41022-010	3/8"	72	12	8435319143896
41022-015	1/2"	60	10	8435319143902
41022-020	3/4"	36	9	8435319143919
41022-025	1"	24	6	8435319143926



VÁLVULA ESFERA PN-30 M-H PASO
TOTAL MANDO PALOMILLA COLOR ROJO
M-F BRASS BALL VALVE PN-30 FULL
BORE WITH RED BUTTERFLY HANDLE

GOLD 

WRAS ACS PZH

4103



CÓDIGO CODE	MEDIDA SIZE			CÓDIGO EAN EAN CODE
4103-008	1/4"	72	12	8435319113875
4103-010	3/8"	72	12	8435319113905
4103-015	1/2"	60	10	8435319113912
4103-020	3/4"	36	9	8435319113936
4103-025	1"	24	6	8435319113943



VÁLVULA ESFERA PN-30 M-H PASO
TOTAL MANDO PALOMILLA COLOR AZUL
M-F BRASS BALL VALVE PN-30 FULL
BORE WITH BLUE BUTTERFLY HANDLE

GOLD 

WRAS ACS PZH

41032



CÓDIGO CODE	MEDIDA SIZE			CÓDIGO EAN EAN CODE
41032-008	1/4"	72	12	8435319143933
41032-010	3/8"	72	12	8435319143940
41032-015	1/2"	60	10	8435319143957
41032-020	3/4"	36	9	8435319143964
41032-025	1"	24	6	8435319143971

VÁLVULA ESFERA CUADRADILLO H-H (27MM.)
F-F BALL VALVE SQUARE HANDLE (27MM.)



ACS

4124



CÓDIGO CODE	MEDIDA SIZE			CÓDIGO EAN EAN CODE
4124-015	1/2"	48	12	8435319115299
4124-020	3/4"	36	9	8435319115305
4124-025	1"	24	6	8435319115312
4124-032	1 1/4"	16	4	8435319115329
4124-040	1 1/2"	8	2	8435319115336
4124-050	2"	8	1	8435319115343

VÁLVULA ESFERA H-H DOBLE TOMA CON PURGA PALANCA
DE ACERO INOXIDABLE F-F BALL VALVE WITH DOUBLE OUTLET
STAINLESS STEEL HANDLE



4099



CÓDIGO CODE	MEDIDA SIZE			CÓDIGO EAN EAN CODE
4099-015	1/2"	20	5	8435319113707
4099-020	3/4"	16	4	8435319113714
4099-025	1"	12	3	8435319113721
4099-032	1 1/4"	12	2	8435319113738
4099-040	1 1/2"	12	2	8435319113745

- Toma manómetro 1/4" BSP
Pressure gauge thread 1/4" BSP

VÁLVULA ESFERA CUADRADILLO H-H
F-F BALL VALVE SQUARE HANDLE



ACS

4105



CÓDIGO CODE	MEDIDA SIZE			CÓDIGO EAN EAN CODE
4105-015*	1/2"	60	10	8435319114018
4105-020*	3/4"	36	9	8435319114025
4105-025*	1"	24	6	8435319114032
4105-032*	1 1/4"	16	4	8435319114049
4105-040**	1 1/2"	8	2	8435319114056
4105-050**	2"	8	1	8435319114063

- *Cuadradillo 20mm. / **Cuadradillo 24,5mm.
*Square handle 20mm. / **Square handle 24,5mm.

SILVER SERIES

PN25

VÁLVULA DE BOLA
BALL VALVE

ANTI CORROSIÓN

ANTI RUST



LEYENDA DE ICONOS ICON KEY

Posibles codificaciones aplicadas en esta sección.

Possible encodings applied in this section.

ACS

PZH



CERTIFICADOS DE PRODUCTO
PRODUCT CERTIFICATES

VÁLVULA ESFERA PN-25 M-H PALANCA ERGONÓMICA COLOR AZUL EN ACERO AL CARBONO CON RECUBRIMIENTO ANTICORROSIÓN

M-F BRASS BALL VALVE PN-25 BLUE ERGONOMIC CARBON STEEL HANDLE WITH ANTICORROSION COATING

SILVER



ACS

PZH

4091

CÓDIGO CODE	MEDIDA SIZE			CÓDIGO EAN EAN CODE
4091-015	1/2"	54	9	8435319144169
4091-020	3/4"	42	7	8435319144176
4091-025	1"	24	6	8435319126028
4091-032	1 1/4"	16	4	8435319126035
4091-040	1 1/2"	8	2	8435319126042
4091-050	2"	12	2	8435319144206



- Recambio maneta disponible
Spare part handle available

VÁLVULA ESFERA PN-25 M-H PALANCA ERGONÓMICA COLOR ROJO EN ACERO AL CARBONO CON RECUBRIMIENTO ANTICORROSIÓN

M-F BRASS BALL VALVE PN-25 RED ERGONOMIC CARBON STEEL HANDLE WITH ANTICORROSION COATING

SILVER



ACS

PZH

40912

CÓDIGO CODE	MEDIDA SIZE			CÓDIGO EAN EAN CODE
40912-015	1/2"	54	9	8435319143322
40912-020	3/4"	42	7	8435319143339
40912-025	1"	24	6	8435319143346
40912-032	1 1/4"	16	4	8435319143353
40912-040	1 1/2"	8	2	8435319143360
40912-050	2"	12	2	8435319143377



- Recambio maneta disponible
Spare part handle available

VÁLVULA ESFERA PN-25 H-H PALANCA ERGONÓMICA COLOR AZUL EN ACERO AL CARBONO CON RECUBRIMIENTO ANTICORROSIÓN

F-F BRASS BALL VALVE PN-25 BLUE ERGONOMIC CARBON STEEL HANDLE WITH ANTICORROSION COATING

SILVER



ACS

PZH

4092

CÓDIGO CODE	MEDIDA SIZE			CÓDIGO EAN EAN CODE
4092-015	1/2"	54	9	8435319144183
4092-020	3/4"	42	7	8435319144190
4092-025	1"	24	6	8435319113042
4092-032	1 1/4"	16	4	8435319113059
4092-040	1 1/2"	8	2	8435319113073
4092-050	2"	12	2	8435319144213
4092-065*	2 1/2"	12	1	8435319113103
4092-080*	3"	6	1	8435319113127
4092-100*	4"	4	1	8435319113141



* Próximamente disponible en palanca con recubrimiento anticorrosión Coming soon in handle with anticorrosion coating

- Recambio maneta disponible
Spare part handle available

VÁLVULA ESFERA PN-25 H-H PALANCA ERGONÓMICA COLOR ROJO EN ACERO AL CARBONO CON RECUBRIMIENTO ANTICORROSIÓN

F-F BRASS BALL VALVE PN-25 RED ERGONOMIC CARBON STEEL HANDLE WITH ANTICORROSION COATING

SILVER



ACS

PZH

40922

CÓDIGO CODE	MEDIDA SIZE			CÓDIGO EAN EAN CODE
40922-015	1/2"	54	9	8435319143384
40922-020	3/4"	42	7	8435319143391
40922-025	1"	24	6	8435319143407
40922-032	1 1/4"	16	4	8435319143414
40922-040	1 1/2"	8	2	8435319143421
40922-050	2"	12	2	8435319143438
40922-065*	2 1/2"	12	1	8435319143445
40922-080*	3"	6	1	8435319143452
40922-100*	4"	4	1	8435319143469



* Próximamente disponible en palanca con recubrimiento anticorrosión Coming soon in handle with anticorrosion coating

- Recambio maneta disponible
Spare part handle available

VÁLVULA ESFERA PN-25 H-H MANDO
PALOMILLA COLOR AZUL
F-F BALL VALVE PN-25 WITH BLUE
BUTTERFLY HANDLE

SILVER

ACS PZH

4093



CÓDIGO CODE	MEDIDA SIZE			CÓDIGO EAN EAN CODE
4093-015	1/2"	60	10	8435319113158
4093-020	3/4"	48	8	8435319113165
4093-025	1"	24	6	8435319113189

VÁLVULA ESFERA PN-25 H-H MANDO
PALOMILLA COLOR ROJO
F-F BALL VALVE PN-25 WITH RED
BUTTERFLY HANDLE

SILVER

ACS PZH

40932



CÓDIGO CODE	MEDIDA SIZE			CÓDIGO EAN EAN CODE
40932-015	1/2"	60	10	8435319143476
40932-020	3/4"	48	8	8435319143483
40932-025	1"	24	6	8435319143490

VÁLVULA ESFERA PN-25 M-H MANDO
PALOMILLA COLOR AZUL
M-F BALL VALVE PN-25 WITH BLUE
BUTTERFLY HANDLE

SILVER

ACS PZH

4094



CÓDIGO CODE	MEDIDA SIZE			CÓDIGO EAN EAN CODE
4094-015	1/2"	60	10	8435319113202
4094-020	3/4"	48	8	8435319113219
4094-025	1"	24	6	8435319113226

VÁLVULA ESFERA PN-25 M-H MANDO
PALOMILLA COLOR ROJO
M-F BALL VALVE PN-25 WITH RED
BUTTERFLY HANDLE

SILVER

ACS PZH

40942



CÓDIGO CODE	MEDIDA SIZE			CÓDIGO EAN EAN CODE
40942-015	1/2"	60	10	8435319143506
40942-020	3/4"	48	8	8435319143513
40942-025	1"	24	6	8435319143520

GRIFOS BIBCOCK RANGE



SERIES

PLATINUM

GOLD

SILVER

LEYENDA DE ICONOS ICON KEY



INOX



Antihielo
Nofrost
system

Inoxidable
Stainless steel

Cierre de
Seguridad
Locking Device

PROPIEDADES DE PRODUCTO
PRODUCT PROPERTIES

GRIFO ESFERA JARDÍN PESADO PN-16
PALANCA ACERO INOXIDABLE COLOR
NEGRO CON RACOR MANGUERA HEAVY
BRASS BALL BIBCOCK GARDEN PN-16
WITH STAINLESS STEEL BLACK HANDLE
AND HOSE CONNECTOR

PLATINUM



4125



CÓDIGO CODE	MEDIDA SIZE			CÓDIGO EAN EAN CODE
4125-01520	1/2" x 3/4"	36	9	8435319128473
4125-02025	3/4" x 1"	16	4	8435319128480
4125-02532	1" x 1 1/4"	12	3	8435319128497

GRIFO ESFERA JARDÍN PN-16 RACOR
MANGUERA BRASS BALL BIBCOCK
GARDEN PN-16 HOSE CONNECTOR

GOLD



4111



CÓDIGO CODE	MEDIDA SIZE			CÓDIGO EAN EAN CODE
4111-01520	1/2" x 3/4"	36	9	8435319114285
4111-02020	3/4" x 3/4"	32	8	8435319114292
4111-02025	3/4" x 1"	24	6	8435319114308
4111-02532	1" x 1 1/4"	12	3	8435319114315

GRIFO ESFERA JARDÍN PN-16 ENCHUFE
RÁPIDO BRASS BALL BIBCOCK GARDEN PN-16
WITH QUICK FEMALE CONNECTOR

GOLD



4142



CÓDIGO CODE	MEDIDA SIZE			CÓDIGO EAN EAN CODE
4142-01520	1/2" x 3/4"	36	9	8435319115374
4142-02025	3/4" x 1"	24	6	8435319115381
4142-02532	1" x 1 1/4"	12	3	8435319127926

GRIFO ESFERA JARDÍN PN-16 CON PALANCA
DE ACERO INOXIDABLE CON RACOR MAN-
GUERA BRASS BALL BIBCOCK GARDEN PN-16
WITH STAINLESS STEEL HANDLE AND HOSE
CONNECTOR

GOLD



4144



CÓDIGO CODE	MEDIDA SIZE			CÓDIGO EAN EAN CODE
4144-01520	1/2" x 3/4"	36	9	8435319115411
4144-02025	3/4" x 1"	24	6	8435319115428
4144-02532	1" x 1 1/4"	12	3	8435319127933

GRIFO ESFERA JARDÍN PN-16 PALANCA
ACERO INOXIDABLE COLOR NEGRO Y ENCHUFE
RÁPIDO BRASS BALL BIBCOCK GARDEN PN-16
STAINLESS STEEL BLACK HANDLE AND QUICK
FEMALE CONNECTOR

GOLD



4123



CÓDIGO CODE	MEDIDA SIZE			CÓDIGO EAN EAN CODE
4123-01520	1/2" x 3/4"	36	9	8435319142912
4123-02025	3/4" x 1"	24	6	8435319142929
4123-02532	1" x 1 1/4"	12	3	8435319142936

GRIFO ESFERA JARDÍN PN-16 RACOR
MANGUERA PALANCA CROMADA CON
CIERRE DE SEGURIDAD BRASS BALL BIB-
COCK PN-16 HOSE CONNECTOR CHROME
HANDLE LOCKING DEVICE

GOLD



4147



CÓDIGO CODE	MEDIDA SIZE			CÓDIGO EAN EAN CODE
4147-01520	1/2" x 3/4"	40	10	8435319127940
4147-02025	3/4" x 1"	24	6	8435319127957
4147-02532	1" x 1 1/4"	12	3	8435319127964

- Candado no incluido
Lock not included

GRIFO ESFERA JARDÍN RACOR MANGUERA
PN-16 MODELO EXPORT BRASS BALL BIBCOCK
GARDEN PN-16 HOSE CONNECTOR TYPE
EXPORT

SILVER

4146



CÓDIGO CODE	MEDIDA SIZE			CÓDIGO EAN EAN CODE
4146-01520	1/2" x 3/4"	36	9	8435319115466
4146-02020	3/4" x 3/4"	32	8	8435319115473
4146-02025	3/4" x 1"	24	6	8435319115480

GRIFO ESFERA JARDÍN ENCHUFE RÁPIDO
PN-16 MODELO EXPORT BRASS BALL BIBCOCK
GARDEN PN-16 QUICK FEMALE CONNECTOR
TYPE EXPORT

SILVER

4143



CÓDIGO CODE	MEDIDA SIZE			CÓDIGO EAN EAN CODE
4143-01520	1/2" x 3/4"	36	9	8435319115398
4143-02025	3/4" x 1"	24	6	8435319115404

GRIFO JARDÍN DE LATÓN PN-10 ENCHUFE MANGUERA
BRASS BIBCOCK GARDEN PN-10 HOSE CONNECTOR



4145



CÓDIGO CODE	MEDIDA SIZE			CÓDIGO EAN EAN CODE
4145-01520	1/2" x 3/4"	40	10	8435319115435
4145-02020	3/4" x 3/4"	24	6	8435319115442
4145-02025	3/4" x 1"	24	6	8435319115459

GRIFO ESFERA JARDÍN ENCHUFE RÁPIDO PN-16 PALANCA CROMADA CON DOS SALIDAS
BRASS BALL BIBCOCK GARDEN TWO OUT-LETS PN-16 CHROME HANDLE WITH QUICK FEMALE CONNECTOR



4148



CÓDIGO CODE	MEDIDA SIZE			CÓDIGO EAN EAN CODE
4148-0152020	1/2" x 3/4" x 3/4"	32	8	8435319128404

VÁLVULA ESFERA PN-16 BARRIL PALANCA ALUMINIO
BARRELL BALL VALVE WITH ALUMINIUM HANDLE PN-16



4149



CÓDIGO CODE	MEDIDA SIZE			CÓDIGO EAN EAN CODE
4149-010	3/8"	40	10	8435319130711
4149-015	1/2"	40	10	8435319130728
4149-020	3/4"	24	6	8435319130735
4149-025	1"	16	4	8435319130742

VÁLVULA ESFERA PN-16 BARRIL PALOMILLA
BARRELL BALL VALVE PN-16



4141



CÓDIGO CODE	MEDIDA SIZE			CÓDIGO EAN EAN CODE
4141-01515	1/2" x 1/2"	42	2	8435319115367
4141-02020	3/4" x 3/4"	30	2	8435319131541

RACOR MANGUERA HEMBRA
TAP FEMALE HOSE CONNECTOR



4122



CÓDIGO CODE	MEDIDA SIZE			CÓDIGO EAN EAN CODE
4122-020	3/4"	320	80	8435319115275
4122-025	1"	200	50	8435319115282
4122-032	1 1/4"	100	25	8435319126073

RACOR HEMBRA ENCHUFE RÁPIDO
QUICK FEMALE CONNECTOR



4121



CÓDIGO CODE	MEDIDA SIZE			CÓDIGO EAN EAN CODE
4121-020	3/4"	320	80	8435319115244
4121-025	1"	200	50	8435319115251
4121-032	1 1/4"	100	25	8435319126066

GRIFO ESFERA JARDÍN ENCHUFE MANGUERA PN-16
INOXIDABLE STAINLESS STEEL BIB COCK GARDEN PN-16
HOSE CONNECTOR



INOX

0921



CÓDIGO CODE	MEDIDA SIZE			CÓDIGO EAN EAN CODE
0921-015	1/2" x 3/4"	30	15	8435319125854
0921-020	3/4" x 3/4"	20	10	8435319125861
0921-025	1" x 1"	10	5	8435319125878

VÁLVULAS DE ESCUADRA

ANGLE VALVES



VÁLVULA ESCUADRA CON FILTRO
ANGLE BALL VALVE WITH FILTER



4404



CÓDIGO CODE	MEDIDA SIZE		CÓDIGO EAN EAN CODE
4404-01510	1/2" x 3/8"	60 15	8435319115770
4404-01515	1/2" x 1/2"	60 15	8435319115787

- Longitud 58,5mm.
Length 58,5mm.

VÁLVULA ESCUADRA LARGA CON FILTRO
LONG ANGLE VALVE WITH FILTER



4405



CÓDIGO CODE	MEDIDA SIZE		CÓDIGO EAN EAN CODE
4405-01510	1/2" x 3/8"	60 15	8435319115794
4405-01520	1/2" x 3/4"	60 15	8435319127971

- Longitud 72mm.
Length 72mm.

VÁLVULA ESCUADRA MODELO EXPORT
ANGLE BALL VALVE MODEL EXPORT



4411



CÓDIGO CODE	MEDIDA SIZE		CÓDIGO EAN EAN CODE
4411-01510	1/2" x 3/8"	60 15	8435319128022
4411-01515	1/2" x 1/2"	60 15	8435319131527

- Longitud 73,5mm.
Length 73,5mm.

VÁLVULA ESCUADRA
ANGLE VALVE



4402



CÓDIGO CODE	MEDIDA SIZE		CÓDIGO EAN EAN CODE
4402-01510	1/2" x 3/8"	60 15	8435319115732
4402-01515	1/2" x 1/2"	60 15	8435319115749
4402-01520	1/2" x 3/4"	60 15	8435319115756

- Longitud 79,5mm.
Length 79,5mm.

VÁLVULA ESCUADRA ANTICAL CON MANDO METÁLICO
ANTI-LIME ANGLE VALVE WITH METAL HANDLE



4422



ANTI CAL / ANTI LIME

CÓDIGO CODE	MEDIDA SIZE		CÓDIGO EAN EAN CODE
4422-01510	1/2" x 3/8"	60 15	8435319131589

- Longitud 79,5mm.
Length 79,5mm.

VÁLVULA ESCUADRA LARGA
LONG ANGLE VALVE



4406



CÓDIGO CODE	MEDIDA SIZE		CÓDIGO EAN EAN CODE
4406-01510	1/2" x 3/8"	60 15	8435319115800

- Longitud 95mm.
Length 95mm.

VÁLVULA ESCUADRA LARGA ANTICAL CON MANDO METÁLICO ANTI-LIME LONG ANGLE VALVE WITH METAL HANDLE



4426

ANTI CAL / ANTI LIME



CÓDIGO	MEDIDA			CÓDIGO EAN
CODE	SIZE			EAN CODE
4426-01510	1/2" x 3/8"	60	15	8435319131565

- Longitud 95mm.
Length 95mm.

VÁLVULA DE ESCUADRA MODELO "DECO" CON MANDO REDONDO ANGLE VALVE 'DECO' TYPE ROUND HANDLE



4409



CÓDIGO	MEDIDA			CÓDIGO EAN
CODE	SIZE			EAN CODE
4409-01510	1/2" x 3/8"	45	1	8435319127988
4409-01515	1/2" x 1/2"	45	1	8435319127995

- Cierre cerámico antical
Anti-lime ceramic seal

VÁLVULA DE ESCUADRA MODELO "DECO" CON MANDO CUADRADO ANGLE VALVE 'DECO' TYPE SQUARE HANDLE



4410



CÓDIGO	MEDIDA			CÓDIGO EAN
CODE	SIZE			EAN CODE
4410-01510	1/2" x 3/8"	45	1	8435319128008
4410-01515	1/2" x 1/2"	45	1	8435319128015

- Cierre cerámico antical
Anti-lime ceramic seal

GRIFO LAVADORA WASHING MACHINE VALVE



4400



CÓDIGO	MEDIDA			CÓDIGO EAN
CODE	SIZE			EAN CODE
4400-01520	1/2" x 3/4"	60	15	8435319115718

GRIFO LAVADORA TIPO "M" WASHING MACHINE VALVE 'M' TYPE



4401



CÓDIGO	MEDIDA			CÓDIGO EAN
CODE	SIZE			EAN CODE
4401-01520	1/2" x 3/4"	48	12	8435319115725

GRIFO LAVADORA SIMPLE CON MANDO METÁLICO SIMPLE WASHING MACHINE VALVE WITH METALIC HANDLE



4434



CÓDIGO	MEDIDA			CÓDIGO EAN
CODE	SIZE			EAN CODE
4434-01520	1/2" x 3/4"	32	8	8435319135884

GRIFO LAVADORA DOBLE CON MANDO METÁLICO DOUBLE WASHING MACHINE VALVE WITH METALIC HANDLE



CÓDIGO	MEDIDA			CÓDIGO EAN
CODE	SIZE			EAN CODE
4435-0152020	1/2" x 3/4" x 3/4"	20	1	8435319135891

4435



VÁLVULA MIXTA LAVADORA LAVABO WASHING MACHINE WASHBASIN MIXED VALVE



CÓDIGO	MEDIDA			CÓDIGO EAN
CODE	SIZE			EAN CODE
4407-01520	1/2" x 3/4" x 3/8"	28	7	8435319115817

4407



OTRAS VÁLVULAS

OTHER VALVES



LEYENDA DE ICONOS ICON KEY

Posibles codificaciones aplicadas en esta sección.

Possible encodings applied in this section.



CERTIFICADOS DE PRODUCTO
PRODUCT CERTIFICATES

INOX

R

Inoxidable
Stainless steel

Recambios
Spare parts

PROPIEDADES DE PRODUCTO
PRODUCT PROPERTIES

VÁLVULA ESFERA SOLDAR PN-30 PALANCA EN ACERO CROMADO SOLDER END BALL VALVE PN-30 WITH CHROMED STEEL HANDLE



4107



CÓDIGO CODE	MEDIDA SIZE		CÓDIGO EAN EAN CODE
4107-015	15	48 8	8435319114117
4107-018	18	48 8	8435319114124
4107-022	22	36 6	8435319114131
4107-028	28	16 4	8435319114148
4107-035	35	12 2	8435319114155
4107-042	42	12 2	8435319114162
4107-054*	54	6 1	8435319114179

- *Disponible hasta agotar existencias
*While stocks lasts

VÁLVULA ESFERA SOLDAR PN-30 MANDO PALOMILLA SOLDER END BALL VALVE PN-30 BUTTERFLY HANDLE



4108



CÓDIGO CODE	MEDIDA SIZE		CÓDIGO EAN EAN CODE
4108-015	15	54 9	8435319114186
4108-018	18	54 9	8435319114193
4108-022	22	42 7	8435319114209
4108-028	28	20 5	8435319114216

VÁLVULA ESFERA MINI PN-16 H-H MANDO METÁLICO COLOR ROJO F-F MINI BALL VALVE PN-16 RED COLOR METAL HANDLE



4109



CÓDIGO CODE	MEDIDA SIZE		CÓDIGO EAN EAN CODE
4109-008	1/4"	144 24	8435319114223
4109-010	3/8"	144 24	8435319114230
4109-015	1/2"	108 18	8435319114247

VÁLVULA ESFERA MINI PN-16 M-H MANDO METÁLICO COLOR ROJO M-F MINI BALL VALVE PN-16 RED COLOR METAL HANDLE



4110



CÓDIGO CODE	MEDIDA SIZE		CÓDIGO EAN EAN CODE
4110-008	1/4"	144 24	8435319114254
4110-010	3/8"	144 24	8435319114261
4110-015	1/2"	108 18	8435319114278
4110-020	3/4"	78 13	8435319135778

VÁLVULA ESFERA MINI PN-16 H-H MANDO METÁLICO COLOR AZUL F-F MINI BALL VALVE PN-16 BLUE COLOR METAL HANDLE



41092



CÓDIGO CODE	MEDIDA SIZE		CÓDIGO EAN EAN CODE
41092-008	1/4"	144 24	8435319108468
41092-010	3/8"	144 24	8435319108475
41092-015	1/2"	108 18	8435319108482

- Disponible en acero inoxidable (Ref. 0914)
Available in stainless steel (Ref. 0914)

VÁLVULA ESFERA MINI PN-16 M-H MANDO METÁLICO COLOR AZUL M-F MINI BALL VALVE PN-16 BLUE COLOR METAL HANDLE



41102



CÓDIGO CODE	MEDIDA SIZE		CÓDIGO EAN EAN CODE
41102-008	1/4"	144 24	8435319108499
41102-010	3/8"	144 24	8435319108505
41102-015	1/2"	108 18	8435319108512

- Disponible en acero inoxidable (Ref. 0915)
Available in stainless steel (Ref. 0915)

VÁLVULA DE COMPUERTA PASO ESTANDAR H-H
F-F GATE VALVE STANDARD FLOW



ACS

4113



CÓDIGO CODE	MEDIDA SIZE			CÓDIGO EAN EAN CODE
4113-015*	1/2"	48	12	8435319114391
4113-020*	3/4"	48	12	8435319114421
4113-025*	1"	32	8	8435319114452
4113-032*	1 1/4"	24	4	8435319114483
4113-040*	1 1/2"	12	3	8435319114513
4113-050*	2"	8	2	8435319114544
4113-065	2 1/2"	4	1	8435319114575
4113-080	3"	4	1	8435319114605
4113-100*	4"	4	1	8435319114636

PN-16*/10**

VÁLVULA COMPUERTA CIERRE ELÁSTICO H-H PASO ESTANDAR
F-F GATE VALVE WITH RUBBER WEDGE STANDARD FLOW



ACS

4113CE



CÓDIGO CODE	MEDIDA SIZE			CÓDIGO EAN EAN CODE
4113-015CE*	1/2"	48	12	8435319114407
4113-020CE*	3/4"	30	5	8435319114438
4113-025CE*	1"	16	4	8435319114469
4113-032CE	1 1/4"	8	2	8435319114490
4113-040CE	1 1/2"	8	2	8435319114520
4113-050CE	2"	6	1	8435319114551

- Compuerta NBR apta para hidrocarburos NBR wedge suitable for hydrocarbons **PN-16*/10****

VÁLVULA DE COMPUERTA PASO TOTAL H-H PN-16
F-F GATE VALVE FULL BORE PN-16



ACS

4113I



CÓDIGO CODE	MEDIDA SIZE			CÓDIGO EAN EAN CODE
4113-015I	1/2"	48	12	8435319114414
4113-020I	3/4"	40	10	8435319114445
4113-025I	1"	24	6	8435319114476
4113-032I	1 1/4"	12	3	8435319114506
4113-040I	1 1/2"	8	2	8435319114537
4113-050I	2"	6	1	8435319114568
4113-065I	2 1/2"	4	1	8435319114599
4113-080I	3"	4	1	8435319114629
4113-100I	4"	4	1	8435319114650

PN-16

VÁLVULA DE RETENCIÓN PESADA CON OBTURADOR
METÁLICO H-H F-F NON RETURN VALVE HEAVY TYPE
WITH METAL SHUTTER



ACS

4114



CÓDIGO CODE	MEDIDA SIZE			CÓDIGO EAN EAN CODE
4114-015*	1/2"	90	15	8435319112823
4114-020*	3/4"	48	12	8435319112830
4114-025*	1"	36	9	8435319112847
4114-032**	1 1/4"	24	6	8435319112854
4114-040**	1 1/2"	8	2	8435319112861
4114-050**	2"	8	2	8435319112878
4114-065***	2 1/2"	6	1	8435319112885
4114-080***	3"	4	1	8435319112892
4114-100***	4"	3	1	8435319112908

- Apto para hidrocarburos cierre NBR NBR seal suitable for hydrocarbons **PN-25*/16***/10*****

VÁLVULA DE RETENCIÓN LIGERA CON OBTURADOR
PLÁSTICO H-H F-F NON RETURN VALVE LIGHT TYPE
WITH PLASTIC SHUTTER



ACS

4115



CÓDIGO CODE	MEDIDA SIZE			CÓDIGO EAN EAN CODE
4115-015*	1/2"	120	20	8435319114667
4115-020*	3/4"	90	15	8435319114674
4115-025*	1"	48	8	8435319114681
4115-032**	1 1/4"	24	6	8435319114698
4115-040**	1 1/2"	16	4	8435319114704
4115-050**	2"	8	2	8435319114711

PN-16*/10**

VÁLVULA DE RETENCIÓN LIGERA CON OBTURADOR
METÁLICO H-H F-F NON RETURN VALVE LIGHT TYPE
WITH METAL SHUTTER



ACS

4215



CÓDIGO CODE	MEDIDA SIZE			CÓDIGO EAN EAN CODE
4215-015*	1/2"	144	24	8435319130766
4215-020*	3/4"	90	15	8435319130773
4215-025*	1"	44	11	8435319130780
4215-032**	1 1/4"	24	6	8435319130797
4215-040**	1 1/2"	20	5	8435319130803
4215-050**	2"	8	2	8435319130810
4215-065***	2 1/2"	8	1	8435319130827
4215-080***	3"	3	1	8435319130834
4215-100***	4"	2	1	8435319130841



PN-16*/10***/8***

FILTRO VÁLVULA DE RETENCIÓN (4114-4115-4215)
FILTER FOR NON RETURN VALVE (4114-4115-4215)



4116





CÓDIGO CODE	MEDIDA SIZE			CÓDIGO EAN EAN CODE
4116-015	1/2"	224	56	8435319114759
4116-020	3/4"	152	38	8435319114766
4116-025	1"	80	20	8435319114773
4116-032	1 1/4"	36	9	8435319114780
4116-040	1 1/2"	24	6	8435319114797
4116-050	2"	16	4	8435319114803
4116-065	2 1/2"	12	1	8435319114810
4116-080	3"	8	1	8435319114827
4116-100	4"	6	1	8435319114834

VÁLVULA DE PIE ROSCA HEMBRA
FOOT VALVE FEMALE THREAD



4117



CÓDIGO CODE	MEDIDA SIZE			CÓDIGO EAN EAN CODE
4117-015*	1/2"	80	20	8435319114841
4117-020*	3/4"	48	12	8435319114858
4117-025*	1"	40	10	8435319114865
4117-032**	1 1/4"	12	3	8435319114872
4117-040**	1 1/2"	12	3	8435319114889
4117-050**	2"	8	1	8435319114896
4117-065***	2 1/2"	4	1	8435319114902
4117-080***	3"	4	1	8435319114919
4117-100***	4"	2	1	8435319114926



PN-16*/10**/8***

VÁLVULA DE FONDO ROSCA HEMBRA PN-16
BOTTOM VALVE FEMALE THREAD PN-16



4118



CÓDIGO CODE	MEDIDA SIZE			CÓDIGO EAN EAN CODE
4118-015	1/2"	60	15	8435319114933
4118-020	3/4"	48	12	8435319114940
4118-025	1"	48	12	8435319114957
4118-032	1 1/4"	20	5	8435319114964
4118-040	1 1/2"	12	3	8435319114971
4118-050	2"	8	2	8435319114988
4118-065	2 1/2"	8	1	8435319114995
4118-080	3"	4	1	8435319115008
4118-100	4"	2	1	8435319115015

- Apto para hidrocarburos junta NBR
NBR seal suitable for hydrocarbons



VÁLVULA DE CLAPETA CIERRE ELÁSTICO H-H
F-F RUBBER WASHER SWING CHECK VALVE



ACS

4119



CÓDIGO CODE	MEDIDA SIZE			CÓDIGO EAN EAN CODE
4119-015*	1/2"	72	12	8435319115039
4119-020*	3/4"	60	10	8435319115046
4119-025*	1"	28	7	8435319115053
4119-032**	1 1/4"	20	5	8435319115060
4119-040**	1 1/2"	16	4	8435319115077
4119-050**	2"	10	1	8435319115084
4119-065***	2 1/2"	5	1	8435319115091
4119-080***	3"	3	1	8435319115107
4119-100***	4"	2	1	8435319115114



PN-16*/10**/8***

FILTRO Y TAMIZ INOXIDABLE H-H PN-16
F-F Y STRAINER WITH STAINLESS STEEL SIEVE PN-16



4120



CÓDIGO CODE	MEDIDA SIZE			CÓDIGO EAN EAN CODE
4120-015	1/2"	96	24	8435319115121
4120-020	3/4"	48	12	8435319115145
4120-025	1"	36	9	8435319115169
4120-032	1 1/4"	16	4	8435319115183
4120-040	1 1/2"	12	2	8435319115206
4120-050	2"	9	1	8435319115220



- Disponible en acero inoxidable (Ref. 0913)
Available in stainless steel (Ref. 0913)

VÁLVULA ESFERA EMPOTRAR PN-30 TERMINAL SOLDAR "CARLA"
LONG NECK SOLDER BALL VALVE PN-30 'CARLA' TYPE



4221



CÓDIGO CODE	MEDIDA SIZE			CÓDIGO EAN EAN CODE
4221-015	15	40	10	8435319115497
4221-018	18	40	10	8435319115503
4221-022	22	32	8	8435319115510



- Lado del cuadradillo 8x8mm. en todas las dimensiones
Side of square 8x8mm. in all dimensions

VÁLVULA ESFERA EMPOTRAR H-H PN-30 "CARLA" ROSCAR
LONG NECK BALL VALVE F-F PN-30 'CARLA' TYPE, THREADED



4222



CÓDIGO CODE	MEDIDA SIZE			CÓDIGO EAN EAN CODE
4222-015	1/2"	48	12	8435319115534
4222-020	3/4"	32	8	8435319115541
4222-025	1"	24	6	8435319115558



- Lado del cuadradillo 8x8mm. en todas las dimensiones
Side of square 8x8mm. in all dimensions

ALARGADERA PARA VÁLVULA "CARLA"
ELONGATION FOR 'CARLA' VALVES



4230



CÓDIGO CODE	MEDIDA SIZE			CÓDIGO EAN EAN CODE
4230-01	-	2000	100	8435319125496

- Lado del cuadradillo 8x8mm. en todas las dimensiones
Side of square 8x8mm. in all dimensions

MANETA Y FLORÓN PARA "CARLA"
HANDLE LONG NECK VALVE M TYPE 'CARLA'



4224

CÓDIGO CODE	MEDIDA SIZE		CÓDIGO EAN EAN CODE
4224-01	M	32 8	8435319115596



- Maneta para lado del cuadradillo 8x8mm.
Handle for 8x8mm. side square

MANDO REDONDO Y FLORÓN PARA "CARLA"
HANDLE LONG NECK VALVES R TYPE 'CARLA'



4225

CÓDIGO CODE	MEDIDA SIZE		CÓDIGO EAN EAN CODE
4225-01	R	32 8	8435319115602



- Maneta para lado del cuadradillo 8x8mm.
Handle for 8x8mm. side square

MANDO OCULTO Y FLORÓN PARA "CARLA"
HANDLE LONG NECK VALVES 'O' TYPE 'CARLA'



4226

CÓDIGO CODE	MEDIDA SIZE		CÓDIGO EAN EAN CODE
4226-01	O	36 9	8435319115619



- Maneta para lado del cuadradillo 8x8mm.
Handle for 8x8mm. side square

VÁLVULA DE SEGURIDAD DE MEMBRANA 3 BAR
DIAPHRAGM SAFETY VALVE 3 BAR



4415

CÓDIGO CODE	MEDIDA SIZE		CÓDIGO EAN EAN CODE
4415-015	1/2"	100 1	8435319126127
4415-020	3/4"	90 1	8435319126134



VÁLVULA DE SEGURIDAD DE MEMBRANA 7 BAR
DIAPHRAGM SAFETY VALVE 7 BAR



4416

CÓDIGO CODE	MEDIDA SIZE		CÓDIGO EAN EAN CODE
4416-015	1/2"	100 1	8435319126141
4416-020	3/4"	90 1	8435319126158



VÁLVULA DE SEGURIDAD PESADA CON PALANCA
8.5 BAR M-H M-F SAFETY VALVE FOR HEATERS WITH
HANDLE 8.5 BAR



4414

CÓDIGO CODE	MEDIDA SIZE		CÓDIGO EAN EAN CODE
4414-020	3/4"	100 1	8435319126110



VÁLVULA DE SEGURIDAD CON PALANCA 8.5 BAR M-H
M-F SAFETY VALVE FOR HEATERS WITH HANDLE 8.5
BAR



4413

CÓDIGO CODE	MEDIDA SIZE		CÓDIGO EAN EAN CODE
4413-015	1/2"	150 1	8435319126103



VÁLVULA DE SEGURIDAD 8.5 BAR M-H
M-F SAFETY VALVE FOR WATER HEATER 8.5 BAR



4412

CÓDIGO CODE	MEDIDA SIZE		CÓDIGO EAN EAN CODE
4412-015	1/2"	150 1	8435319126080
4412-020	3/4"	100 1	8435319126097



VÁLVULA CLICK CLACK UNIVERSAL Ø 37mm. BRASS WASTE FOR
BASIN WITH CLICK-CLACK UNIVERSAL Ø 37mm.



4419

CÓDIGO CODE	MEDIDA SIZE		CÓDIGO EAN EAN CODE
4419-032	1 1/4"	36 1	8435319131534



VÁLVULA CLICK CLACK Ø 37mm.
BRASS WASTE FOR WASH BASIN WITH CLICK-CLACK Ø 37mm.



4417

CÓDIGO CODE	MEDIDA SIZE		CÓDIGO EAN EAN CODE
4417-032	1 1/4"	24 1	8435319126165



VÁLVULA CLICK CLACK Ø 66mm.
BRASS WASTE FOR BASIN WITH CLICK-CLACK Ø 66mm.



4418



CÓDIGO CODE	MEDIDA SIZE			CÓDIGO EAN EAN CODE
4418-032	1 1/4"	24	1	8435319126172

VÁLVULA ESFERA PN-30 PALANCA INOX. COLOR ROJO CON
CONEXIÓN PE BALL VALVE PN-30 RED S.S. HANDLE WITH
CONNECTIONS PE



4100



CÓDIGO CODE	MEDIDA SIZE			CÓDIGO EAN EAN CODE
4100-020	20	24	6	8435319113752
4100-025	25	16	4	8435319113769
4100-032	32	12	3	8435319113776

VÁLVULA ESFERA PN-30 PALANCA INOX. COLOR ROJO CON
CONEXIÓN PE-H BALL VALVE PN-30 RED S.S. HANDLE WITH
CONNECTIONS PE-H



4101



CÓDIGO CODE	MEDIDA SIZE			CÓDIGO EAN EAN CODE
4101-01520	1/2" x 20	32	8	8435319113783
4101-02025	3/4" x 25	24	6	8435319113790
4101-02532	1" x 32	16	4	8435319113806

ACCESORIO DE LATÓN ROSCADO

BRASS THREADED FITTING



SERIE 87

CURVA 90° M-H
M-F LONG SWEEP BEND 90°



87001



CÓDIGO CODE	MEDIDA SIZE			CÓDIGO EAN EAN CODE
87001-015	1/2"	120	10	8435319108529
87001-020	3/4"	70	10	8435319108536
87001-025	1"	40	5	8435319108543
87001-032	1 1/4"	20	5	8435319108550
87001-040	1 1/2"	10	5	8435319108567
87001-050	2"	17	1	8435319108574

- Rosca macho paralela
Parallel male thread

CURVA 90° H-H
F-F LONG SWEEP BEND 90°



87002



CÓDIGO CODE	MEDIDA SIZE			CÓDIGO EAN EAN CODE
87002-015	1/2"	120	10	8435319108581
87002-020	3/4"	70	10	8435319108598
87002-025	1"	40	5	8435319108604
87002-032	1 1/4"	20	5	8435319108611
87002-040	1 1/2"	10	5	8435319108628
87002-050	2"	17	1	8435319108635

CODO 90° H-H
F-F ELBOW 90°



87090



CÓDIGO CODE	MEDIDA SIZE			CÓDIGO EAN EAN CODE
87090-010	3/8"	340	10	8435319108642
87090-015	1/2"	180	10	8435319108659
87090-020	3/4"	110	10	8435319108673
87090-025	1"	60	5	8435319108697
87090-032	1 1/4"	35	5	8435319108727
87090-040	1 1/2"	30	5	8435319108741
87090-050	2"	36	1	8435319108772
87090-065	2 1/2"	16	1	8435319108789
87090-080	3"	12	1	8435319108796
87090-100	4"	4	1	8435319108802

CODO 90° REDUCIDO H-H
F-F REDUCING ELBOW 90°



87090R



CÓDIGO CODE	MEDIDA SIZE			CÓDIGO EAN EAN CODE
87090-01510	1/2" x 3/8"	230	10	1234567891234
87090-02015	3/4" x 1/2"	130	10	8435319108666
87090-02515	1" x 1/2"	100	5	8435319108680
87090-02520	1" x 3/4"	75	5	8435319108703
87090-03225	1 1/4" x 1"	50	5	8435319108710
87090-04025	1 1/2" x 1"	40	5	8435319108734
87090-04032	1 1/2" x 1 1/4"	30	5	8435319108758

CODO 90° M-H
M-F ELBOW 90°



87092



CÓDIGO CODE	MEDIDA SIZE			CÓDIGO EAN EAN CODE
87092-010	3/8"	280	10	8435319108819
87092-015	1/2"	200	10	8435319108826
87092-020	3/4"	100	10	8435319108833
87092-025	1"	60	5	8435319108840
87092-032	1 1/4"	35	5	8435319108857
87092-040	1 1/2"	25	5	8435319108864
87092-050	2"	32	1	8435319108871
87092-065	2 1/2"	17	1	8435319108888
87092-080	3"	12	1	8435319108895

- Rosca macho paralela
Parallel male thread

CODO 90° M-M
M-M ELBOW 90°



87093



CÓDIGO CODE	MEDIDA SIZE			CÓDIGO EAN EAN CODE
87093-010	3/8"	480	10	8435319148372
87093-015	1/2"	240	10	8435319148389
87093-020	3/4"	120	10	8435319148396

- Rosca macho paralela
Parallel male thread

CODO 90° M-H CON CONECTOR 2 PIEZAS
M-F ELBOW 90° WITH 2 PIECES CONNECTOR

87098

NEW



CÓDIGO CODE	MEDIDA SIZE			CÓDIGO EAN EAN CODE
87098-015	1/2"	100	10	8435319148419
87098-020	3/4"	60	10	8435319148426
87098-025	1"	30	5	8435319148433

- Rosca macho paralela
Parallel male thread

TE IGUAL H
F EQUAL TEE

87130



CÓDIGO CODE	MEDIDA SIZE			CÓDIGO EAN EAN CODE
87130-010	3/8"	180	10	8435319108901
87130-015	1/2"	120	10	8435319108918
87130-020	3/4"	60	10	8435319108925
87130-025	1"	45	5	8435319108956
87130-032	1 1/4"	25	5	8435319108987
87130-040	1 1/2"	20	5	8435319109021
87130-050	2"	26	1	8435319109076
87130-065	2 1/2"	12	1	8435319109137
87130-080	3"	6	1	8435319109144
87130-100	4"	4	1	8435319109151

TE REDUCIDA H
F REDUCING TEE

87130R



CÓDIGO CODE	MEDIDA SIZE			CÓDIGO EAN EAN CODE
87130-01510	1/2" x 3/8"	130	10	8435319141700
87130-02015	3/4" x 1/2"	90	10	8435319108949
87130-02515	1" x 1/2"	60	5	8435319108963
87130-02520	1" x 3/4"	50	5	8435319108970
87130-03215	1 1/4" x 1/2"	40	5	8435319108994
87130-03220	1 1/4" x 3/4"	30	5	8435319109007
87130-03225	1 1/4" x 1"	30	5	8435319109014
87130-04015	1 1/2" x 1/2"	25	5	8435319109038
87130-04020	1 1/2" x 3/4"	25	5	8435319109045
87130-04025	1 1/2" x 1"	25	5	8435319109052
87130-04032	1 1/2" x 1 1/4"	20	5	8435319109069
87130-05015	2" x 1/2"	42	1	8435319109083
87130-05020	2" x 3/4"	42	1	8435319109090
87130-05025	2" x 1"	42	1	8435319109106
87130-05032	2" x 1 1/4"	36	1	8435319109113

TE IGUAL MACHO
M EQUAL TEE

87132

NEW



CÓDIGO CODE	MEDIDA SIZE			CÓDIGO EAN EAN CODE
87132-015	1/2"	200	10	8435319148440
87132-020	3/4"	90	10	8435319148457

- Rosca macho paralela
Parallel male thread

CRUZ H
F CROSS

87180



CÓDIGO CODE	MEDIDA SIZE			CÓDIGO EAN EAN CODE
87180-010	3/8"	200	10	8435319109168
87180-015	1/2"	110	10	8435319109175
87180-020	3/4"	60	10	8435319109182
87180-025	1"	35	5	8435319109199
87180-032	1 1/4"	20	5	8435319109205
87180-040	1 1/2"	15	5	8435319109212
87180-050	2"	18	1	8435319109229

MANGUITO REDUCCIÓN H-H
F-F REDUCING SOCKET

87240



CÓDIGO CODE	MEDIDA SIZE			CÓDIGO EAN EAN CODE
87240-01510	1/2" x 3/8"	300	10	8435319109236
87240-02010	3/4" X 3/8"	250	10	8435319148464
87240-02015	3/4" x 1/2"	210	10	8435319109243
87240-02515	1" x 1/2"	160	5	8435319109250
87240-02520	1" x 3/4"	150	5	8435319109267
87240-03225	1 1/4" x 1"	90	5	8435319109274
87240-04025	1 1/2" x 1"	70	5	8435319109281
87240-04032	1 1/2" x 1 1/4"	60	5	8435319109298
87240-05025	2" x 1"	76	1	8435319109304
87240-05032	2" x 1 1/4"	76	1	8435319109311
87240-05040	2" x 1 1/2"	76	1	8435319109328

TUERCA REDUCCIÓN M-H
M-F REDUCING BUSHINGS



87241



CÓDIGO CODE	MEDIDA SIZE			CÓDIGO EAN EAN CODE
87241-01008*	3/8" x 1/4"	800	10	8435319109335
87241-01506	1/2" x 1/8"	600	10	8435319148471
87241-01508*	1/2" x 1/4"	500	10	8435319109342
87241-01510*	1/2" x 3/8"	500	10	8435319109359
87241-02010	3/4" x 3/8"	400	10	8435319148488
87241-02015*	3/4" x 1/2"	300	10	8435319109366
87241-02515*	1" x 1/2"	200	5	8435319109373
87241-02520*	1" x 3/4"	200	5	8435319109380
87241-03220*	1 1/4" x 3/4"	140	5	8435319109397
87241-03225*	1 1/4" x 1"	140	5	8435319109403
87241-04025**	1 1/2" x 1"	115	5	8435319109410
87241-04032**	1 1/2" x 1 1/4"	115	5	8435319109427
87241-05025**	2" x 1"	140	1	8435319109434
87241-05032**	2" x 1 1/4"	140	1	8435319109441
87241-05040**	2" x 1 1/2"	120	1	8435319109458
87241-06532**	2 1/2" x 1 1/4"	90	1	8435319109465
87241-06540**	2 1/2" x 1 1/2"	90	1	8435319109472
87241-06550**	2 1/2" x 2"	90	1	8435319109489
87241-08050**	3" x 2"	56	1	8435319109496
87241-08065**	3" x 2 1/2"	56	1	8435319109502
87241-10050**	4" x 2"	26	1	8435319109519
87241-10065**	4" x 2 1/2"	26	1	8435319109526
87241-10080**	4" x 3"	26	1	8435319109533

- * Hexagonal / Hexagonal
- ** Octogonal / Octagonal
- Rosca macho paralela
Parallel male thread

MANGUITO REDUCCIÓN M-H
M-F REDUCING NIPPLE SOCKET



87246



CÓDIGO CODE	MEDIDA SIZE			CÓDIGO EAN EAN CODE
87246-00810*	1/4" x 3/8"	500	10	8435319109670
87246-01008*	3/8" x 1/4"	750	10	8435319109687
87246-01015*	3/8" x 1/2"	400	10	8435319109694
87246-01020	3/8" x 3/4"	180	10	8435319148495
87246-01510*	1/2" x 3/8"	500	10	8435319109700
87246-01520*	1/2" x 3/4"	280	10	8435319109717
87246-01525*	1/2" x 1"	180	10	8435319109724
87246-02015*	3/4" x 1/2"	280	10	8435319109731
87246-02025*	3/4" x 1"	160	10	8435319109748
87246-02520*	1" x 3/4"	150	5	8435319109755
87246-02532**	1" x 1 1/4"	105	5	8435319109762
87246-02540**	1" x 1 1/2"	75	5	8435319109779
87246-02550**	1" x 2"	115	5	8435319109786
87246-03240**	1 1/4" x 1 1/2"	70	5	8435319109793
87246-03250**	1 1/4" x 2"	110	5	8435319109809
87246-04050**	1 1/2" x 2"	110	5	8435319109816

- * Hexagonal / Hexagonal
- ** Octogonal / Octagonal
- Rosca macho paralela
Parallel male thread

MACHÓN REDUCIDO M-M
M-M REDUCING NIPPLE



87245



CÓDIGO CODE	MEDIDA SIZE			CÓDIGO EAN EAN CODE
87245-01008*	3/8" x 1/4"	600	10	8435319109540
87245-01508*	1/2" x 1/4"	400	10	8435319109557
87245-01510*	1/2" x 3/8"	500	10	8435319109564
87245-02010	3/4" x 3/8"	280	10	8435319148501
87245-02015*	3/4" x 1/2"	270	10	8435319109571
87245-02515*	1" x 1/2"	160	5	8435319109588
87245-02520*	1" x 3/4"	150	5	8435319109595
87245-03220*	1 1/4" x 3/4"	100	5	8435319109601
87245-03225*	1 1/4" x 1"	95	5	8435319109618
87245-04025**	1 1/2" x 1"	80	5	8435319109625
87245-04032**	1 1/2" x 1 1/4"	70	5	8435319109632
87245-05025**	2" x 1"	120	1	8435319109649
87245-05032**	2" x 1 1/4"	120	1	8435319109656
87245-05040**	2" x 1 1/2"	96	1	8435319109663

- * Hexagonal / Hexagonal
- ** Octogonal / Octagonal
- Rosca macho paralela
Parallel male thread

MANGUITO H-H
F-F SOCKET



87270



CÓDIGO CODE	MEDIDA SIZE			CÓDIGO EAN EAN CODE
87270-010	3/8"	400	10	8435319109823
87270-015	1/2"	230	10	8435319109830
87270-020	3/4"	140	10	8435319109847
87270-025	1"	100	10	8435319109854
87270-032	1 1/4"	55	5	8435319109861
87270-040	1 1/2"	35	5	8435319109878
87270-050	2"	45	1	8435319109885
87270-065	2 1/2"	30	1	8435319109892
87270-080	3"	21	1	8435319109908
87270-100	4"	12	1	8435319109915

- Rosca macho paralela
Parallel male thread

MANGUITO ANTIELECTRÓLISIS H-H
F-F ANTI-ELECTROLYTIC SOCKET



87271



CÓDIGO CODE	MEDIDA SIZE			CÓDIGO EAN EAN CODE
87271-015	1/2"	400	25	8435319141717
87271-020	3/4"	200	15	8435319141724
87271-025	1"	100	10	8435319141731
87271-032	1 1/4"	45	1	8435319141748
87271-040	1 1/2"	30	1	8435319141755
87271-050	2"	20	1	8435319141762

MACHÓN M-M
M-M HEXAGON NIPPLE



87280



CÓDIGO CODE	MEDIDA SIZE		CÓDIGO EAN EAN CODE
87280-008*	1/4"	800 10	8435319109922
87280-010*	3/8"	500 10	8435319109939
87280-015*	1/2"	300 10	8435319109946
87280-020*	3/4"	200 10	8435319109953
87280-025*	1"	120 5	8435319109960
87280-032*	1 1/4"	75 5	8435319109977
87280-040**	1 1/2"	60 5	8435319109984
87280-050**	2"	96 1	8435319109991
87280-065**	2 1/2"	45 1	8435319110003
87280-080**	3"	32 1	8435319110010
87280-100**	4"	12 1	8435319110027

- * Hexagonal / Hexagonal
- ** Octogonal / Octagonal
- Rosca macho paralela
Parallel male thread

TAPÓN MACHO CON REBORDE
M PLUG BEADED



87290



CÓDIGO CODE	MEDIDA SIZE		CÓDIGO EAN EAN CODE
87290-008*	1/4"	900 10	8435319110034
87290-010*	3/8"	600 10	8435319110041
87290-015*	1/2"	470 10	8435319110058
87290-020*	3/4"	300 10	8435319110065
87290-025*	1"	200 5	8435319110072
87290-032*	1 1/4"	120 5	8435319110089
87290-040*	1 1/2"	110 5	8435319110096
87290-050*	2"	160 1	8435319110102
87290-065**	2 1/2"	84 1	8435319110119
87290-080**	3"	56 1	8435319110126
87290-100**	4"	24 1	8435319110133

- * Hexagonal / Hexagonal
- ** Octogonal / Octagonal
- Rosca macho paralela
Parallel male thread

TAPÓN HEXAGONAL H
F HEXAGON CAP



87300



CÓDIGO CODE	MEDIDA SIZE		CÓDIGO EAN EAN CODE
87300-010*	3/8"	600 10	8435319110140
87300-015*	1/2"	430 10	8435319110157
87300-020*	3/4"	300 10	8435319110164
87300-025*	1"	200 5	8435319110171
87300-032**	1 1/4"	150 5	8435319110188
87300-040**	1 1/2"	110 5	8435319110195
87300-050**	2"	135 1	8435319110201

- * Hexagonal / Hexagonal
- ** Octogonal / Octagonal

ENTRONQUE MANGUERA
HEXAGON HOSE NIPPLE



87315



CÓDIGO CODE	MEDIDA SIZE		CÓDIGO EAN EAN CODE
87315-00810	1/4" x 10	600 10	8435319135815
87315-00812	1/4" x 12	350 10	8435319135822
87315-01012	3/8" x 12	300 10	8435319110218
87315-01512	1/2" x 12	300 10	8435319135839
87315-01514	1/2" x 14	280 10	8435319110225
87315-01516	1/2" x 16	240 10	8435319135846
87315-01518	1/2" x 18	230 10	8435319135853
87315-01520	1/2" x 20	190 10	8435319135860
87315-02020	3/4" x 20	140 10	8435319110232
87315-02025	3/4" x 25	120 10	8435319144251
87315-02525	1" x 25	100 5	8435319110249
87315-02530	1" x 30	80 5	8435319131107
87315-03230	1 1/4" x 30	50 5	8435319144268
87315-03235	1 1/4" x 35	50 5	8435319110256
87315-03238	1 1/4" x 38	40 5	8435319144275
87315-03240	1 1/4" x 40	40 5	8435319131114
87315-04038	1 1/2" x 38	30 5	8435319144282
87315-04045	1 1/2" x 45	30 5	8435319110263
87315-04050	1 1/2" x 50	20 5	8435319131121
87315-05060	2" x 60	33 1	8435319110270

- Rosca macho paralela
Parallel male thread

TE CINCO VÍAS
FIVE WAY TEE



87318



CÓDIGO CODE	MEDIDA SIZE		CÓDIGO EAN EAN CODE
87318-025	1"	30 5	8435319110287

- Rosca macho paralela
Parallel male thread

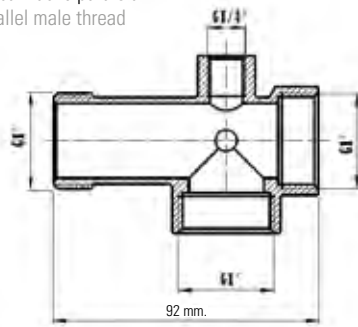

TUERCA UNIÓN ASIENTO CÓNICO H-H
F-F STRAIGHT UNION TAPERED SEAT



87340



CÓDIGO CODE	MEDIDA SIZE		CÓDIGO EAN EAN CODE
87340-015*	1/2"	140 10	8435319110294
87340-020*	3/4"	80 10	8435319110300
87340-025*	1"	60 5	8435319110317
87340-032**	1 1/4"	30 5	8435319110324
87340-040**	1 1/2"	25 5	8435319110331
87340-050**	2"	30 1	8435319110348

- * Hexagonal / Hexagonal
- ** Octogonal / Octagonal

TUERCA UNIÓN ASIENTO CÓNICO M-H
M-F STRAIGHT UNION TAPERED SEAT



87341



CÓDIGO CODE	MEDIDA SIZE		CÓDIGO EAN EAN CODE
87341-015*	1/2"	120 10	8435319110355
87341-020*	3/4"	70 10	8435319110362
87341-025*	1"	45 5	8435319110379
87341-032**	1 1/4"	30 5	8435319110386
87341-040**	1 1/2"	20 5	8435319110393
87341-050**	2"	24 1	8435319110409

- * Hexagonal / Hexagonal
- ** Octogonal / Octagonal
- Rosca macho paralela
Parallel male thread

TUERCA UNIÓN TRES PIEZAS LATÓN M-H ASIENTO CÓNICO C/JUNTA
M-F THREE PIECES BRASS STRAIGHT UNION TAPERED SEAT WITH O-RING



873412



CÓDIGO CODE	MEDIDA SIZE		CÓDIGO EAN EAN CODE
873412-015	1/2"	130 10	8435319144299
873412-020	3/4"	80 10	8435319144305
873412-025	1"	50 5	8435319144312
873412-032	1 1/4"	30 5	8435319144329
873412-040	1 1/2"	20 5	8435319144336
873412-050	2"	12 1	8435319144343

- * Hexagonal / Hexagonal
- ** Octogonal / Octagonal
- Rosca macho paralela
Parallel male thread

RACOR CODO MURAL M-H
F-F WALL PLATED ELBOW



87500



CÓDIGO CODE	MEDIDA SIZE		CÓDIGO EAN EAN CODE
87500-015	1/2"	140 10	8435319148402

MANGUITO IGUAL M-H (HEXÁGONO INTERIOR)
M-F EQUAL SOCKET (HEXAGON INSIDE)



87530



CÓDIGO CODE	MEDIDA SIZE		CÓDIGO EAN EAN CODE
87530-1502	1/2" x 2 cm.	250 10	8435319110492

- Rosca macho paralela
Parallel male thread

MANGUITO IGUAL M-H "TIPO MARSELLA"
M-F EQUAL SOCKET 'MARSELLA TYPE'



87529



CÓDIGO CODE	MEDIDA SIZE		CÓDIGO EAN EAN CODE
87529-008	1/4"	800 10	8435319110416
87529-010	3/8"	500 10	8435319110423
87529-015	1/2"	320 10	8435319110430
87529-020	3/4"	220 10	8435319110447
87529-025	1"	110 5	8435319110454
87529-032	1 1/4"	80 5	8435319110461
87529-040	1 1/2"	50 5	8435319110478
87529-050	2"	70 1	8435319110485

- Rosca macho paralela
Parallel male thread

MANGUITO IGUAL M-H
M-F EQUAL SOCKET



87532



CÓDIGO CODE	MEDIDA SIZE		CÓDIGO EAN EAN CODE
87532-01503	1/2" x 3 cm.	250 10	8435319141779

- Rosca macho paralela
Parallel male thread

MANGUITO IGUAL M-H (HEXÁGONO INTERIOR)
M-F EQUAL SOCKET (HEXAGON INSIDE)



87531



CÓDIGO CODE	MEDIDA SIZE		CÓDIGO EAN EAN CODE
87531-015	1/2" x 1 cm.	220 10	8435319135761



- Rosca macho paralela
Parallel male thread

ALARGADERA ACABADO LATÓN M-H (HEXÁGONO INTERIOR)
M-F EXTENSION FITTING BRASS FINISH (HEXAGON INSIDE)



87533



CÓDIGO CODE	MEDIDA SIZE			CÓDIGO EAN EAN CODE
87533-015020	1/2" x 20 mm.	300	10	8435319131404
87533-015030	1/2" x 30 mm.	200	10	8435319131411
87533-015050	1/2" x 50 mm.	130	5	8435319131428
87533-015100	1/2" x 100 mm.	90	5	8435319131435
87533-020050	3/4" x 50 mm.	90	5	8435319131442
87533-020100	3/4" x 100 mm.	60	5	8435319131459

- Rosca macho paralela
Parallel male thread

RACOR DEPÓSITO CON TUERCA CORREDERA
TANK OUTLET CONNECTION



87550





CÓDIGO CODE	MEDIDA SIZE			CÓDIGO EAN EAN CODE
87550-010	3/8"	180	10	8435319110508
87550-015	1/2"	120	10	8435319110515
87550-020	3/4"	80	10	8435319110522
87550-025	1"	50	5	8435319110539
87550-032	1 1/4"	30	5	8435319110546
87550-040	1 1/2"	25	1	8435319110553
87550-050	2"	30	1	8435319110560
87550-065	2 1/2"	22	1	8435319110577
87550-080	3"	10	1	8435319110584

RACOR BARCELONA MANGUERA
HOSE COUPLING BARCELONA HOSE-HOSE



87560





CÓDIGO CODE	MEDIDA SIZE			CÓDIGO EAN EAN CODE
87560-020	20 x 20	120	10	8435319110591
87560-025	25 x 25	60	10	8435319110607
87560-030	30 x 30	40	5	8435319110614
87560-035	35 x 35	25	5	8435319110621
87560-040	40 x 40	22	1	8435319110638
87560-045	45 x 45	13	1	8435319110645
87560-050	50 x 50	22	1	8435319110652
87560-060	60 x 60	15	1	8435319110669

RACOR BARCELONA M-M
M-M HOSE COUPLING BARCELONA



87561



CÓDIGO CODE	MEDIDA SIZE			CÓDIGO EAN EAN CODE
87561-015	1/2" x 1/2"	150	10	8435319110676
87561-020	3/4" x 3/4"	110	10	8435319110683
87561-025	1" x 1"	70	5	8435319110690
87561-032	1 1/4" x 1 1/4"	35	5	8435319110706
87561-040	1 1/2" x 1 1/2"	22	1	8435319110713
87561-050	2" x 2"	24	1	8435319110720

RACOR BARCELONA MACHO MANGUERA
M HOSE COUPLING BARCELONA HOSE



87562





CÓDIGO CODE	MEDIDA SIZE			CÓDIGO EAN EAN CODE
87562-1520	1/2" x 20	140	10	8435319110737
87562-2025	3/4" x 25	80	10	8435319110744
87562-2530	1" x 30	50	5	8435319110751
87562-3235	1 1/4" x 35	30	5	8435319110768
87562-4045	1 1/2" x 45	18	1	8435319110775
87562-5060	2" x 60	20	1	8435319110782

TABLA RECAMBIO JUNTAS (RACOR BARCELONA)
GASKETS SPARE PARTS TABLE (HOSE BARCELONA)

RACOR BARCELONA HOSE BARCELONA	JUNTA O-RING	MEDIDA SIZE
87560-020		
87561-015	DN15	97900-015
87562-1520		
87560-025		
87561-020	DN20	97900-020
87562-2025		
87560-030		
87561-025	DN25	97900-025
87562-2530		
87560-035		
87560-040	DN32	97900-032
87561-032		
87562-3235		
87560-045		
87561-040	DN40	97900-040
87562-4045		
87560-050	50mm.	97900-050mm.
87560-060		
87561-050	DN50	97900-050
87562-5060		

RACOR HEMBRA DOS PIEZAS MANGUERA H
FEMALE TWO PIECES HOSE NIPPLE



87563

CÓDIGO CODE	MEDIDA SIZE		CÓDIGO EAN EAN CODE
87563-01514	1/2" x 14	300 10	8435319131312
87563-02020	3/4" x 20	180 10	8435319131329
87563-02525	1" x 25	100 5	8435319131336
87563-03230	1 1/4" x 30	80 5	8435319131343
87563-03235	1 1/4" x 35	80 5	8435319131350
87563-04040	1 1/2" x 40	50 1	8435319131367



ANILLO REDUCIDO M-H
REDUCING RING M-F



87575

CÓDIGO CODE	MEDIDA SIZE		CÓDIGO EAN EAN CODE
87575-01510	1/2" x 3/8"	450 10	8435319148518
87575-02015	3/4" x 1/2"	280 10	8435319148525

NEW



- Rosca macho paralela
Parallel male thread

CONEXIÓN GAS TE
TEE GAS CONNECTION



82130

CÓDIGO CODE	MEDIDA SIZE		CÓDIGO EAN EAN CODE
82130-008	8mm.	400 10	8435319130698



CONEXIÓN GAS Y
Y GAS CONNECTION



82220

CÓDIGO CODE	MEDIDA SIZE		CÓDIGO EAN EAN CODE
82220-008	8mm.	400 10	8435319130704



MANGUITO CONEXIÓN GAS
GAS CONNECTION SOCKET



82270

CÓDIGO CODE	MEDIDA SIZE		CÓDIGO EAN EAN CODE
82270-008	8mm.	800 10	8435319130681



VÁLVULAS DE FLOTADOR Y BOYAS

FLOAT VALVES AND BUOYS

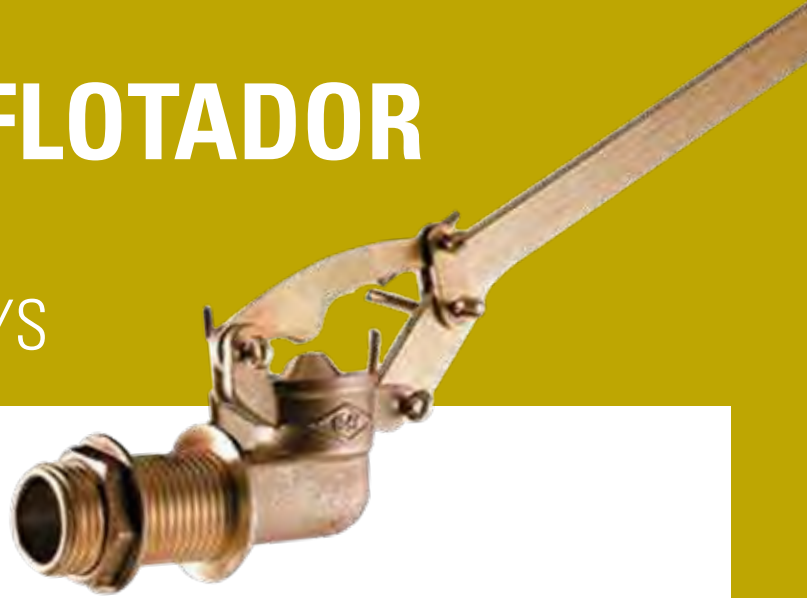

NEW



VÁLVULA FLOTADOR CON VARILLA PLANA
FLOAT VALVE WITH FLAT BAR

228410

PRÓXIMO LANZAMIENTO

CÓDIGO	MEDIDA			CÓDIGO EAN
CODE	SIZE			EAN CODE
228410-015	1/2"	-	-	8435319150061
228410-020	3/4"	-	-	8435319150078
228410-025	1"	-	-	8435319150085
228410-032	1 1/4"	-	-	8435319150092
228410-040	1 1/2"	-	-	8435319150108
228410-050	2"	-	-	8435319150115

NEW



VÁLVULA FLOTADOR CON VARILLA ROSCADA
FLOAT VALVE WITH THREADED ROD

228420

PRÓXIMO LANZAMIENTO

CÓDIGO	MEDIDA	ROSCA VARILLA			CÓDIGO EAN
CODE	SIZE	ROD THREAD			EAN CODE
228420-015	1/2"	6/100	-	-	8435319150122
228420-020	3/4"	7/100	-	-	8435319150139
228420-025	1"	8/100	-	-	8435319150146
228420-032	1 1/4"	9/100	-	-	8435319150153
228420-040	1 1/2"	9/100	-	-	8435319150160
228420-050	2"	9/100	-	-	8435319150177

NEW



BOYA DE PLÁSTICO ESFÉRICA PARA VÁLVULA FLOTADOR CON VARILLA ROSCADA
SPHERIC PLASTIC BUOY FOR FLOAT VALVE WITH THREADED ROD

228421

PRÓXIMO LANZAMIENTO

CÓDIGO	MEDIDA	ROSCA VARILLA	DIÁMETRO			CÓDIGO EAN
CODE	SIZE	ROD THREAD	DIAMETER			EAN CODE
228421-015	1/2"	6/100	11	-	-	8435319150184
228421-020	3/4"	7/100	13	-	-	8435319150191
228421-025	1"	8/100	15	-	-	8435319150207
228421-03240	1 1/4" - 1 1/2"	9/100	20	-	-	8435319150214
228421-050	2"	9/100	23	-	-	8435319150221

NEW



BOYA DE PLÁSTICO MIXTA PARA VÁLVULA FLOTADOR VARILLA PLANA Y ROSCADA
MIXED PLASTIC BUOY FOR FLOAT VALVE WITH FLAT AND THREADED ROD

228431

PRÓXIMO LANZAMIENTO

CÓDIGO	MEDIDA	ROSCA VARILLA	DIÁMETRO			CÓDIGO EAN
CODE	SIZE	ROD THREAD	DIAMETER			EAN CODE
228431-015	1/2"	6/100	12	-	-	8435319150238
228431-020	3/4"	7/100	12	-	-	8435319150245
228431-025	1"	8/100	15	-	-	8435319150252
228431-03240	1 1/4" - 1 1/2"	9/100	20	-	-	8435319150269
228431-050	2"	9/100	25	-	-	8435319150276

ACCESORIO DE LATÓN ROSCADO CROMADO CHROME PLATED BRASS THREADED FITTING



NEW

SERIE 871

NEW



CODO 90° H-H
F-F ELBOW 90°

871090

CÓDIGO CODE	MEDIDA SIZE			CÓDIGO EAN EAN CODE
871090-010	3/8"	340	10	8435319147504
871090-015	1/2"	180	10	8435319147511
871090-020	3/4"	110	10	8435319147528
871090-025	1"	60	5	8435319147535

NEW



CODO 90° M-H
M-F ELBOW 90°

871092

CÓDIGO CODE	MEDIDA SIZE			CÓDIGO EAN EAN CODE
871092-010	3/8"	280	10	8435319147542
871092-015	1/2"	200	10	8435319147559
871092-020	3/4"	100	10	8435319147566
871092-025	1"	60	5	8435319147573

- Rosca macho paralela
Parallel male thread

NEW



RACOR CODO MURAL
WALL PLATED ELBOW

871500

CÓDIGO CODE	MEDIDA SIZE			CÓDIGO EAN EAN CODE
871500-015	1/2"	140	10	8435319147580

NEW



TE IGUAL H
F EQUAL TEE

871130



CÓDIGO CODE	MEDIDA SIZE			CÓDIGO EAN EAN CODE
871130-010	3/8"	150	10	8435319147597
871130-015	1/2"	120	10	8435319147603
871130-020	3/4"	60	10	8435319147610
871130-025	1"	45	5	8435319147627

NEW



MANGUITO REDUCCIÓN H-H
F-F REDUCING SOCKET

871240



CÓDIGO CODE	MEDIDA SIZE			CÓDIGO EAN EAN CODE
871240-01510	1/2" x 3/8"	300	10	8435319147634
871240-02015	3/4" x 1/2"	210	10	8435319147641

NEW



TUERCA REDUCCIÓN M-H
M-F REDUCING BUSHINGS

871241

CÓDIGO CODE	MEDIDA SIZE			CÓDIGO EAN EAN CODE
871241-01510*	1/2" x 3/8"	500	10	8435319147658
871241-02015*	3/4" x 1/2"	300	10	8435319147665



- * Hexagonal / Hexagonal
- ** Octogonal / Octagonal
- Rosca macho paralela
Parallel male thread

NEW



MACHÓN REDUCIDO M-M
M-M REDUCING NIPPLE

871245

CÓDIGO CODE	MEDIDA SIZE			CÓDIGO EAN EAN CODE
871245-01510	1/2" x 3/8"	500	10	8435319147504
871245-02015	3/4" x 1/2"	270	10	8435319147511



- Rosca macho paralela
Parallel male thread

NEW



MANGUITO REDUCCIÓN M-H
M-F REDUCING NIPPLE SOCKET

871246

CÓDIGO CODE	MEDIDA SIZE			CÓDIGO EAN EAN CODE
871246-01015	3/8" x 1/2"	400	10	8435319147696
871246-01510	1/2" x 3/8"	500	10	8435319147702
871246-01520	1/2" x 3/4"	280	10	8435319147719
871246-02015	3/4" x 1/2"	280	10	8435319147726
871246-02520	1" x 3/4"	150	5	8435319147733



- Rosca macho paralela
Parallel male thread

NEW



MANGUITO H-H
F-F SOCKET

871270



CÓDIGO CODE	MEDIDA SIZE			CÓDIGO EAN EAN CODE
871270-010	3/8"	400	10	8435319147740
871270-015	1/2"	230	10	8435319147757
871270-020	3/4"	140	10	8435319147764
871270-025	1"	100	10	8435319147771

NEW



MACHÓN M-M
M-M HEXAGON NIPPLE

871280

CÓDIGO CODE	MEDIDA SIZE			CÓDIGO EAN EAN CODE
871280-010	3/8"	500	10	8435319147788
871280-015	1/2"	300	10	8435319147795
871280-020	3/4"	200	10	8435319147801
871280-025	1"	120	5	8435319147818



- Rosca macho paralela
Parallel male thread

NEW



TAPÓN MACHO CON REBORDE
M PLUG BEADED

871290

CÓDIGO CODE	MEDIDA SIZE			CÓDIGO EAN EAN CODE
871290-010	3/8"	600	10	8435319147825
871290-015	1/2"	470	10	8435319147832
871290-020	3/4"	300	10	8435319147849
871290-025	1"	200	5	8435319147856



- Rosca macho paralela
Parallel male thread

NEW



TAPÓN HEXAGONAL H
F HEXAGON CAP

871300

CÓDIGO CODE	MEDIDA SIZE			CÓDIGO EAN EAN CODE
871300-010	3/8"	600	10	8435319147863
871300-015	1/2"	430	10	8435319147870
871300-020	3/4"	300	10	8435319147887
871300-025	1"	200	5	8435319147894

NEW



MANGUITO IGUAL M-H "TIPO MARSELLA"
M-F EQUAL SOCKET 'MARSELLA TYPE'

871529

CÓDIGO CODE	MEDIDA SIZE			CÓDIGO EAN EAN CODE
871529-010	3/8"	500	10	8435319147900
871529-015	1/2"	320	10	8435319147917
871529-020	3/4"	220	10	8435319147924
871529-025	1"	110	5	8435319147931

- Rosca macho paralela
Parallel male thread

NEW



ALARGADERA M-H (HEX. INTERIOR)
M-F EXTENSION FITTING (HEXAGON INSIDE)

87534

CÓDIGO CODE	MEDIDA SIZE			CÓDIGO EAN EAN CODE
87534-015020	1/2" x 20 mm.	225	25	8435319131466
87534-015050	1/2" x 50 mm.	120	5	8435319131473
87534-015100	1/2" x 100 mm.	90	5	8435319131480

- Rosca macho paralela
Parallel male thread

NEW



MANGUITO IGUAL M-H (HEXÁGONO INTERIOR)
M-F EQUAL SOCKET (HEXAGON INSIDE)

871531

CÓDIGO CODE	MEDIDA SIZE			CÓDIGO EAN EAN CODE
871531-015	1/2" x 1 CM	250	10	8435319147948

- Rosca macho paralela
Parallel male thread

ACCESORIO DE LATÓN PARA TUBERÍA DE COBRE

BRASS FITTING FOR COPPER PIPE

SERIE 86



CODO H-Cu
F-Cu ELBOW



86090



CÓDIGO CODE	MEDIDA SIZE		CÓDIGO EAN EAN CODE
86090-1215	12 x 1/2"	300 25	8435319107492
86090-1415	14 x 1/2"	300 25	8435319107508
86090-1515	15 x 1/2"	250 25	8435319107515
86090-1815	18 x 1/2"	250 25	8435319107522
86090-1820	18 x 3/4"	160 10	8435319107539
86090-2215	22 x 1/2"	160 10	8435319107546
86090-2220	22 x 3/4"	130 10	8435319107553
86090-2820	28 x 3/4"	90 10	8435319107577
86090-2825	28 x 1"	70 5	8435319107584

CODO M-Cu
M-Cu ELBOW



86092



CÓDIGO CODE	MEDIDA SIZE		CÓDIGO EAN EAN CODE
86092-1215	12 x 1/2"	325 25	8435319107591
86092-1415	14 x 1/2"	300 25	8435319107607
86092-1515	15 x 1/2"	300 25	8435319107614
86092-1815	18 x 1/2"	250 25	8435319107621
86092-2215	22 x 1/2"	160 10	8435319107638
86092-2220	22 x 3/4"	130 10	8435319107645

- Rosca macho paralela
Parallel male thread

TE H-Cu
F-Cu TEE



86130



CÓDIGO CODE	MEDIDA SIZE		CÓDIGO EAN EAN CODE
86130-1215	12 x 1/2"	275 25	8435319107652
86130-1415	14 x 1/2"	250 25	8435319107669
86130-1515	15 x 1/2"	250 25	8435319107676
86130-1815	18 x 1/2"	150 10	8435319107683
86130-2215	22 x 1/2"	120 10	8435319107690
86130-2820	28 x 3/4"	60 5	8435319107706

CRUZ Cu
Cu EQUAL CROSS



86180



CÓDIGO CODE	MEDIDA SIZE		CÓDIGO EAN EAN CODE
86180-015	15	200 10	8435319107713
86180-018	18	130 10	8435319107720
86180-022	22	80 10	8435319107737
86180-028	28	40 5	8435319107744

CODO MURAL H-Cu
F-Cu WALL PLATED ELBOW



86472



CÓDIGO CODE	MEDIDA SIZE		CÓDIGO EAN EAN CODE
86472-1215	12 x 1/2"	240 10	8435319108345
86472-1415	14 x 1/2"	220 10	8435319108352
86472-1515	15 x 1/2"	220 10	8435319108369
86472-1820	18 x 3/4"	120 10	8435319108376
86472-2215	22 x 1/2"	120 10	8435319108383
86472-2220	22 x 3/4"	110 10	8435319108390

TAPÓN Cu
Cu CAP



86301



CÓDIGO CODE	MEDIDA SIZE		CÓDIGO EAN EAN CODE
86301-012	12	600 25	8435319107966
86301-014	14	1050 25	8435319107973
86301-015	15	500 25	8435319107980
86301-018	18	500 10	8435319107997
86301-022	22	420 10	8435319108000
86301-028	28	200 5	8435319108017

ENLACE H-Cu
F-Cu STRAIGHT CONNECTOR



86270



CÓDIGO CODE	MEDIDA SIZE		CÓDIGO EAN EAN CODE
86270-1215	12 x 1/2"	500 25	8435319107850
86270-1415	14 x 1/2"	475 25	8435319107867
86270-1515	15 x 1/2"	350 25	8435319107874
86270-1520	15 x 3/4"	300 25	8435319107881
86270-1815	18 x 1/2"	375 25	8435319107898
86270-1820	18 x 3/4"	275 25	8435319107904
86270-2215	22 x 1/2"	300 25	8435319107911
86270-2220	22 x 3/4"	200 10	8435319107928
86270-2225	22 x 1"	150 10	8435319107935
86270-2820	28 x 3/4"	150 10	8435319107942
86270-2825	28 x 1"	110 10	8435319107959

ENTRONQUE M-Cu
M-Cu STRAIGHT CONNECTOR



86243



CÓDIGO CODE	MEDIDA SIZE		CÓDIGO EAN EAN CODE
86243-1215	12 x 1/2"	400 25	8435319135877
86243-1415	14 x 1/2"	400 25	8435319135792
86243-1515	15 x 1/2"	400 25	8435319135785
86243-1520	15 x 3/4"	350 25	8435319107751
86243-1815	18 x 1/2"	350 25	8435319107768
86243-1820	18 x 3/4"	300 25	8435319107775
86243-2220	22 x 3/4"	250 10	8435319107782
86243-2225	22 x 1"	180 10	8435319107799
86243-2820	28 x 3/4"	190 10	8435319107805
86243-2825	28 x 1"	160 10	8435319107812
86243-3532*	35 x 1 1/4"	100 5	8435319107829

- Rosca macho paralela
Parallel male thread
- *Disponible hasta agotar existencias
*While stocks lasts

RACOR DOS PIEZAS RECTO H-Cu
F-Cu STRAIGHT TAP CONNECTION



86359



CÓDIGO CODE	MEDIDA SIZE		CÓDIGO EAN EAN CODE
86359-1215	12 x 1/2"	350 25	8435319108024
86359-1415	14 x 1/2"	325 25	8435319108031
86359-1515	15 x 1/2"	325 25	8435319108048
86359-1520	15 x 3/4"	250 25	8435319108055
86359-1815	18 x 1/2"	250 25	8435319108062
86359-1820	18 x 3/4"	190 10	8435319108079
86359-1825	18 x 1"	130 10	8435319108086
86359-2215	22 x 1/2"	210 10	8435319108093
86359-2220	22 x 3/4"	160 10	8435319108109
86359-2225	22 x 1"	120 10	8435319108116
86359-2825	28 x 1"	90 10	8435319108123

- Asiento plano
Flat seat
- Junta plana de fibra
Fiber flat gasket

RACOR DOS PIEZAS RECTO CON PRECINTO H-Cu
F-Cu STRAIGHT CONNECTION WITH SEAL HOLE



86360



CÓDIGO CODE	MEDIDA SIZE		CÓDIGO EAN EAN CODE
86360-1215	12 x 1/2"	350 25	8435319108130
86360-1415	14 x 1/2"	325 25	8435319108147
86360-1515	15 x 1/2"	325 25	8435319108154
86360-1520	15 x 3/4"	250 25	8435319108161
86360-1815	18 x 1/2"	250 25	8435319108178
86360-1820	18 x 3/4"	190 10	8435319108185
86360-1825	18 x 1"	130 10	8435319108192
86360-2215	22 x 1/2"	210 10	8435319108208
86360-2220	22 x 3/4"	160 10	8435319108215
86360-2225	22 x 1"	120 10	8435319108222
86360-2825	28 x 1"	90 10	8435319108239

- Asiento cónico
Tapered seat

RACOR DOS PIEZAS CURVO H-Cu
F-Cu BEND TAP CONNECTION



86361



CÓDIGO CODE	MEDIDA SIZE		CÓDIGO EAN EAN CODE
86361-1215	12 x 1/2"	300 25	8435319108246
86361-1415	14 x 1/2"	275 25	8435319108253
86361-1515	15 x 1/2"	225 25	8435319108260
86361-1520	15 x 3/4"	150 25	8435319108277
86361-1815	18 x 1/2"	250 25	8435319108284
86361-1820	18 x 3/4"	140 10	8435319108291
86361-1825	18 x 1"	90 10	8435319108307
86361-2215	22 x 1/2"	140 10	8435319108314
86361-2220	22 x 3/4"	130 10	8435319108321
86361-2225	22 x 1"	70 10	8435319108338

- Asiento cónico
Tapered seat

ABRAZADERA TAPAPOROS
BRASS SEALING CLAMP



86362



CÓDIGO CODE	MEDIDA SIZE		CÓDIGO EAN EAN CODE
86362-010	10	150 10	8435319127193
86362-012	12	140 10	8435319127209
86362-015	15	90 10	8435319127216
86362-018	18	80 10	8435319127223
86362-022	22	50 10	8435319127230
86362-028	28	40 5	8435319127247
86362-035	35	25 5	8435319127254
86362-042	42	15 5	8435319127261
86362-054	54	10 5	8435319127278

- Para tubo cobre hidrosanitario e inoxidable
Hydrosanitary copper and stainless steel pipes

ABRAZADERA TAPAPOROS CON DERIVACIÓN
BRASS SEALING CLAMP WITH FEMALE THREADED OUTLET



86363



CÓDIGO CODE	MEDIDA SIZE		CÓDIGO EAN EAN CODE
86363-01515	15 x 1/2"	80 10	8435319128299
86363-01815	18 x 1/2"	70 10	8435319128305
86363-02215	22 x 1/2"	50 10	8435319128312
86363-02820	28 x 3/4"	30 5	8435319128329
86363-03520	35 x 3/4"	25 5	8435319128336
86363-04225	42 x 1"	15 5	8435319128343
86363-05432	54 x 1 1/4"	10 5	8435319128350

- Para tubo cobre hidrosanitario e inoxidable
Hydrosanitary copper and stainless steel pipes

ACCESORIO DE LATÓN PARA TUBO DE HIERRO

BRASS COMPRESSION FITTING FOR IRON PIPE

SERIE
98



MANGUITO ACOPLAMIENTO Fe-Fe
Fe-Fe STRAIGHT COUPLING



98010

CÓDIGO CODE	MEDIDA SIZE		CÓDIGO EAN EAN CODE
98010-021	21 70 10		8435319111895
98010-027	27 50 10		8435319111901
98010-034	34 30 5		8435319111918
98010-043	43 22 2		8435319111925
98010-049	49 15 1		8435319111932
98010-061	61 18 1		8435319111949



MANGUITO HIERRO Fe-PE
Fe-PE STRAIGHT



98020

CÓDIGO CODE	MEDIDA SIZE		CÓDIGO EAN EAN CODE
98020-02021	20 x 21 70 10		8435319111956
98020-02527	25 x 27 50 10		8435319111963
98020-03234	32 x 34 30 5		8435319111970
98020-04043	40 x 43 22 2		8435319111987
98020-05049	50 x 49 15 1		8435319111994
98020-06361	63 x 61 18 1		8435319112007



RACOR RECTO MACHO Fe-M
Fe-M STRAIGHT COUPLING



98090

CÓDIGO CODE	MEDIDA SIZE		CÓDIGO EAN EAN CODE
98090-02115	21 X 1/2" 120 10		8435319112014
98090-02720	27 x 3/4" 80 10		8435319112021
98090-03425	34 x 1" 55 5		8435319112038
98090-04332	43 x 1 1/4" 36 2		8435319112045
98090-04940	49 x 1 1/2" 24 1		8435319112052
98090-06150	61 x 2" 30 1		8435319112069



- Rosca macho paralela
Parallel male thread

RACOR RECTO HEMBRA Fe-H
Fe-F FEMALE COUPLING



98110

CÓDIGO CODE	MEDIDA SIZE		CÓDIGO EAN EAN CODE
98110-02115	21 x 1/2" 100 10		8435319112076
98110-02720	27 x 3/4" 80 10		8435319112083
98110-03425	34 x 1" 50 5		8435319112090
98110-04332	43 x 1 1/4" 36 2		8435319112106
98110-04940	49 x 1 1/2" 20 1		8435319112113
98110-06150	61 x 2" 28 1		8435319112120



ACCESORIO Y VÁLVULAS DE LATÓN A COMPRESIÓN PARA TUBO DE COBRE E INOXIDABLE

BRASS COMPRESSION FITTING AND VALVES FOR
FOR COPPER AND STAINLESS STEEL PIPE



SERIE 66

LEYENDA DE ICONOS
ICON KEY



CERTIFICADOS DE PRODUCTO
PRODUCT CERTIFICATES

ENLACE DOBLE
STRAIGHT COUPLING



6601



CÓDIGO CODE	MEDIDA SIZE		CÓDIGO EAN EAN CODE
6601-012	12 x 12	300 10	8435319106549
6601-015	15 x 15	240 10	8435319106556
6601-018	18 x 18	160 10	8435319106563
6601-022	22 x 22	140 10	8435319106587
6601-028	28 x 28	70 10	8435319106617
6601-035	35 x 35	45 5	8435319106631
6601-042	42 x 42	35 5	8435319106648
6601-054	54 x 54	30 5	8435319106655

ENLACE DOBLE REDUCCIÓN
REDUCING STRAIGHT COUPLING



6601R



CÓDIGO CODE	MEDIDA SIZE		CÓDIGO EAN EAN CODE
6601-01815	18 x 15	180 10	8435319106570
6601-02215	22 x 15	150 10	8435319106594
6601-02218	22 x 18	130 10	8435319106600
6601-02822	28 x 22	100 10	8435319106624

ENLACE HEMBRA
FEMALE STRAIGHT COUPLING



6602



CÓDIGO CODE	MEDIDA SIZE		CÓDIGO EAN EAN CODE
6602-01215	12 x 1/2"	300 10	8435319106662
6602-01510	15 x 3/8"	220 10	8435319106679
6602-01515	15 x 1/2"	220 10	8435319106686
6602-01520	15 x 3/4"	180 10	8435319106693
6602-01525	15 x 1"	100 10	8435319141489
6602-01815	18 x 1/2"	220 10	8435319106716
6602-01820	18 x 3/4"	160 10	8435319106723
6602-02215	22 x 1/2"	150 10	8435319106730
6602-02220	22 x 3/4"	140 10	8435319106747
6602-02225	22 x 1"	100 5	8435319106754
6602-02820	28 x 3/4"	80 5	8435319106761
6602-02825	28 x 1"	80 5	8435319106778

ENLACE MACHO
MALE STRAIGHT COUPLING



6603



CÓDIGO CODE	MEDIDA SIZE		CÓDIGO EAN EAN CODE
6603-01510	15 x 3/8"	300 10	8435319106785
6603-01515	15 x 1/2"	300 10	8435319106792
6603-01520	15 x 3/4"	190 10	8435319106808
6603-01815	18 x 1/2"	170 10	8435319106815
6603-01820	18 x 3/4"	150 10	8435319106822
6603-02215	22 x 1/2"	150 10	8435319106839
6603-02220	22 x 3/4"	140 10	8435319106846
6603-02225	22 x 1"	110 10	8435319106853
6603-02820	28 x 3/4"	100 10	8435319106860
6603-02825	28 x 1"	80 5	8435319106877

- Rosca macho paralela
Parallel male thread

CODO 90°
ELBOW 90°



6604



CÓDIGO CODE	MEDIDA SIZE			CÓDIGO EAN EAN CODE
6604-015	15 x 15	200	10	8435319106884
6604-018	18 x 18	130	10	8435319106891
6604-022	22 x 22	90	10	8435319106907
6604-028	28 x 28	60	10	8435319106914
6604-035	35 x 35	30	5	8435319106921
6604-042	42 x 42	20	1	8435319106938
6604-054	54 x 54	28	1	8435319106945

CODO 90° HEMBRA
FEMALE ELBOW 90°



6605



CÓDIGO CODE	MEDIDA SIZE			CÓDIGO EAN EAN CODE
6605-01515	15 x 1/2"	170	10	8435319106952
6605-01520	15 x 3/4"	140	10	8435319106969
6605-01815	18 x 1/2"	140	10	8435319106976
6605-01820	18 x 3/4"	110	10	8435319106983
6605-02215	22 x 1/2"	110	10	8435319106990
6605-02220	22 x 3/4"	100	10	8435319107003
6605-02225	22 x 1"	60	10	8435319107010
6605-02825	28 x 1"	60	10	8435319107027

CODO 90° MACHO
MALE ELBOW 90°



6606



CÓDIGO CODE	MEDIDA SIZE			CÓDIGO EAN EAN CODE
6606-01515	15 x 1/2"	200	10	8435319107034
6606-01520	15 x 3/4"	160	10	8435319107041
6606-01815	18 x 1/2"	160	10	8435319107058
6606-01820	18 x 3/4"	130	10	8435319107065
6606-02215	22 x 1/2"	120	10	8435319107072
6606-02220	22 x 3/4"	110	10	8435319107089
6606-02225	22 x 1"	70	10	8435319107096
6606-02825	28 x 1"	60	5	8435319107102

- Rosca macho paralela
Parallel male thread

TAPÓN
CAP



6607



CÓDIGO CODE	MEDIDA SIZE			CÓDIGO EAN EAN CODE
6607-015	15	400	10	8435319107119
6607-018	18	350	10	8435319107126
6607-022	22	230	10	8435319107133

TE IGUAL
EQUAL TEE



6608



CÓDIGO CODE	MEDIDA SIZE			CÓDIGO EAN EAN CODE
6608-015	15 x 15 x 15	120	10	8435319107140
6608-018	18 x 18 x 18	80	10	8435319107157
6608-022	22 x 22 x 22	60	10	8435319107164
6608-028	28 x 28 x 28	35	5	8435319107171
6608-035	35 x 35 x 35	20	5	8435319107188
6608-042	42 x 42 x 42	15	1	8435319107195
6608-054	54 x 54 x 54	18	1	8435319107201

TE REDUCIDA
REDUCING TEE



6609



CÓDIGO CODE	MEDIDA SIZE			CÓDIGO EAN EAN CODE
6609-0152215	15 x 22 x 15	80	10	8435319107218
6609-0181518	18 x 15 x 18	80	10	8435319107225
6609-0181815	18 x 18 x 15	80	10	8435319107232
6609-0221515	22 x 15 x 15	90	10	8435319107249
6609-0221522	22 x 15 x 22	70	10	8435319107256
6609-0221822	22 x 18 x 22	70	10	8435319107263
6609-0222215	22 x 22 x 15	70	10	8435319107270
6609-0282222	28 x 22 x 22	50	10	8435319107287
6609-0282815	28 x 28 x 15	40	10	8435319107294
6609-0282822	28 x 28 x 22	30	10	8435319107300

TE HEMBRA
FEMALE TEE



6610



CÓDIGO CODE	MEDIDA SIZE			CÓDIGO EAN EAN CODE
6610-0151515	15 x 1/2" x 15	120	10	8435319107317
6610-0181518	18 x 1/2" x 18	100	10	8435319107324
6610-0182018	18 x 3/4" x 18	80	10	8435319107331
6610-0221522	22 x 1/2" x 22	80	10	8435319107348
6610-0222022	22 x 3/4" x 22	60	10	8435319107355
6610-0282028	28 x 3/4" x 28	40	5	8435319107362
6610-0282528	28 x 1" x 28	35	5	8435319107379

CODO PLACA
WALL PLATED ELBOW



6611



CÓDIGO CODE	MEDIDA SIZE			CÓDIGO EAN EAN CODE
6611-01515	15 x 1/2"	120	10	8435319107386
6611-01815	18 x 1/2"	100	10	8435319107393
6611-01820	18 x 3/4"	70	10	8435319107409
6611-02215	22 x 1/2"	60	10	8435319107416
6611-02220	22 x 3/4"	50	10	8435319107423

CURVA PUENTE
CROSSOVER

WRAS



6612



CÓDIGO	MEDIDA			CÓDIGO EAN
CODE	SIZE			EAN CODE
6612-015	15 x 15	100	10	8435319107430
6612-018	18 x 18	60	10	8435319107447
6612-022	22 x 22	40	5	8435319107454

VÁLVULA ESFERA MANDO PALOMILLA ENLACE COMPRESIÓN LATÓN
BALL VALVE BUTTERFLY HANDLE COMPRESSION BRASS ENDS



6650



CÓDIGO	MEDIDA			CÓDIGO EAN
CODE	SIZE			EAN CODE
6650-015	15	60	10	8435319107461
6650-018	18	60	10	8435319107478
6650-022	22	36	6	8435319107485

ACCESORIO DE LATÓN A COMPRESIÓN PARA TUBERÍAS PE

BRASS COMPRESSION FITTING FOR PE PIPES



NEW

SERIE
HS

MANGUITO ACOPLAMIENTO PE-PE
STRAIGHT COUPLING PE-PE



HS501

CÓDIGO CODE	MEDIDA SIZE		CÓDIGO EAN EAN CODE
HS501-01	20 130 10		8435319134368
HS501-02	25 70 10		8435319133958
HS501-03	32 40 5		8435319133965
HS501-04	40 24 2		8435319133972
HS501-05	50 17 1		8435319133989
HS501-06	63 20 1		8435319133996

NEW



PN-25

CODO 90° PE-PE
EQUAL ELBOW PE-PE



HS502

CÓDIGO CODE	MEDIDA SIZE		CÓDIGO EAN EAN CODE
HS502-01	20 100 10		8435319134009
HS502-02	25 50 10		8435319134016
HS502-03	32 30 5		8435319134023
HS502-04	40 18 2		8435319134030
HS502-05	50 11 1		8435319134047
HS502-06	63 13 1		8435319134054

NEW



PN-25

TE IGUAL PE
EQUAL TEE PE



HS505

CÓDIGO CODE	MEDIDA SIZE		CÓDIGO EAN EAN CODE
HS505-01	20 60 10		8435319134061
HS505-02	25 40 10		8435319134078
HS505-03	32 20 5		8435319134085
HS505-04	40 12 2		8435319134092
HS505-05	50 8 1		8435319134108
HS505-06	63 8 1		8435319134115

NEW



PN-25

RACOR RECTO MACHO PE-M
MALE COUPLING PE-M



HS506

CÓDIGO CODE	MEDIDA SIZE		CÓDIGO EAN EAN CODE
HS506-01120	20 x 1/2"	190 10	8435319134122
HS506-02340	25 x 3/4"	120 10	8435319134139
HS506-03100	32 x 1"	70 5	8435319134146
HS506-04114	40 x 1 1/4"	40 2	8435319134153
HS506-05112	50 x 1 1/2"	27 1	8435319134160
HS506-06200	63 x 2"	26 1	8435319134177

NEW



- Rosca macho paralela
- Parallel male thread

PN-25

RACOR RECTO HEMBRA PE-H
FEMALE COUPLING PE-F



HS507

NEW



CÓDIGO CODE	MEDIDA SIZE		CÓDIGO EAN EAN CODE
HS507-01120	20 x 1/2"	180 10	8435319134184
HS507-02340	25 x 3/4"	100 10	8435319134191
HS507-03100	32 x 1"	55 5	8435319134207
HS507-04114	40 x 1 1/4"	36 2	8435319134214
HS507-05112	50 x 1 1/2"	27 1	8435319134221
HS507-06200	63 x 2"	30 1	8435319134238

PN-25

CODO 90° MACHO PE-M
MALE ELBOW 90° PE-M



HS508

NEW



CÓDIGO CODE	MEDIDA SIZE		CÓDIGO EAN EAN CODE
HS508-01120	20 x 1/2"	140 10	8435319134245
HS508-02340	25 x 3/4"	90 10	8435319134252
HS508-03100	32 x 1"	50 5	8435319134269
HS508-04114	40 x 1 1/4"	26 2	8435319134276
HS508-05112	50 x 1 1/2"	17 1	8435319134283
HS508-06200	63 x 2"	20 1	8435319134290

- Rosca macho paralela
- Parallel male thread

PN-25

CODO 90° HEMBRA PE-H
FEMALE ELBOW 90° PE-F



HS509

NEW



CÓDIGO CODE	MEDIDA SIZE		CÓDIGO EAN EAN CODE
HS509-01120	20 x 1/2"	180 10	8435319134306
HS509-02340	25 x 3/4"	80 10	8435319134313
HS509-03100	32 x 1"	45 5	8435319134320
HS509-04114	40 x 1 1/4"	26 2	8435319134337
HS509-05112	50 x 1 1/2"	17 1	8435319134344
HS509-06200	63 x 2"	17 1	8435319134351

PN-25

TE HEMBRA PE-H
FEMALE TEE PE-F



HS510

NEW



CÓDIGO CODE	MEDIDA SIZE		CÓDIGO EAN EAN CODE
HS510-01120	20 x 1/2"	80 10	8435319134429
HS510-02340	25 x 3/4"	50 10	8435319134436
HS510-03100	32 x 1"	25 5	8435319134443
HS510-04114	40 x 1 1/4"	18 2	8435319134450
HS510-05112	50 x 1 1/2"	10 1	8435319134467
HS510-06200	63 x 2"	11 1	8435319134474

PN-25

CODO MURAL
WALL PLATED ELBOW



HS511

NEW



CÓDIGO CODE	MEDIDA SIZE		CÓDIGO EAN EAN CODE
HS511-01120	20 x 1/2"	80 10	8435319134481
HS511-02340	25 x 3/4"	50 10	8435319134498
HS511-03100	32 x 1"	30 5	8435319134504

PN-25

ACCESORIO DE COMPRESIÓN PARA TUBERÍA MULTICAPA Y PEX

COMPRESSION FITTING FOR MULTILAYER AND PEX PIPE

SERIE 641

LEYENDA DE ICONOS
ICON KEY

KOMO

DINCERTCO





CERTIFICADOS DE PRODUCTO
PRODUCT CERTIFICATES





KOMO **DINCERTCO** 

CODO 90°
EQUAL ELBOW 90°

641090



CÓDIGO CODE	MEDIDA SIZE	ESPESOR THICKNESS			CÓDIGO EAN EAN CODE
641090-016	16	2.0	120	10	8435319134511
641090-018	18	2.0	100	10	8435319142837
641090-020	20	2.0	90	10	8435319134528
641090-025	25	2.5	60	5	8435319134535
641090-026	26	3.0	60	5	8435319134542
641090-032	32	3.0	40	5	8435319134559





KOMO **DINCERTCO** 

CODO HEMBRA 90°
FEMALE ELBOW 90°

641091



CÓDIGO CODE	MEDIDA SIZE	ESPESOR THICKNESS			CÓDIGO EAN EAN CODE
641091-01615	16 x 1/2"	2.0	150	10	8435319134672
641091-01620	16 x 3/4"	2.0	130	10	8435319134689
641091-02015	20 x 1/2"	2.0	110	10	8435319134696
641091-02020	20 x 3/4"	2.0	90	10	8435319134702
641091-02520	25 x 3/4"	2.5	60	5	8435319134726
641091-02525	25 x 1"	2.5	50	5	8435319134733
641091-02620	26 x 3/4"	3.0	60	5	8435319134740
641091-02625	26 x 1"	3.0	50	5	8435319134757
641091-03225	32 x 1"	3.0	40	5	8435319134764





KOMO **DINCERTCO** 

CODO MACHO 90°
MALE ELBOW 90°

641092



CÓDIGO CODE	MEDIDA SIZE	ESPESOR THICKNESS			CÓDIGO EAN EAN CODE
641092-01615	16 x 1/2"	2.0	180	10	8435319134573
641092-01620	16 x 3/4"	2.0	140	10	8435319134580
641092-01815	18 x 1/2"	2.0	130	10	8435319142844
641092-02015	20 x 1/2"	2.0	120	10	8435319134597
641092-02020	20 x 3/4"	2.0	100	10	8435319134603
641092-02520	25 x 3/4"	2.5	70	5	8435319134627
641092-02525	25 x 1"	2.5	60	5	8435319134634
641092-02620	26 x 3/4"	3.0	70	5	8435319134641
641092-02625	26 x 1"	3.0	60	5	8435319134658
641092-03225	32 x 1"	3.0	40	5	8435319134665



KOMO **DINCERTCO** 

RACOR TE
EQUAL TEE

641130

CÓDIGO CODE	MEDIDA SIZE	ESPESOR THICKNESS			CÓDIGO EAN EAN CODE
641130-016	16	2.0	100	10	8435319135136
641130-018	18	2.0	70	10	8435319142875
641130-020	20	2.0	60	5	8435319135143
641130-025	25	2.5	40	5	8435319135150
641130-026	26	3.0	40	5	8435319135167
641130-032	32	3.0	24	3	8435319135174



KOMO **DINCERTCO**

RACOR TE HEMBRA
FEMALE TEE

641131

CÓDIGO CODE	MEDIDA SIZE	ESPEJOR THICKNESS			CÓDIGO EAN EAN CODE
641131-01615	16 x 1/2"	2.0	100	10	8435319135198
641131-02015	20 x 1/2"	2.0	70	10	8435319135204
641131-02020	20 x 3/4"	2.0	60	10	8435319135211
641131-02520	25 x 3/4"	2.5	50	5	8435319135228
641131-02525	25 x 1"	2.5	40	5	8435319135907
641131-02620	26 x 3/4"	3.0	50	5	8435319135235
641131-02625	26 x 1"	3.0	40	5	8435319135242
641131-03225	32 x 1"	3.0	30	3	8435319135259



KOMO **DINCERTCO**

RACOR TE MACHO
MALE TEE

641132

CÓDIGO CODE	MEDIDA SIZE	ESPEJOR THICKNESS			CÓDIGO EAN EAN CODE
641132-01615	16 x 1/2"	2.0	110	10	8435319135266
641132-02015	20 x 1/2"	2.0	80	10	8435319135273
641132-02020	20 x 3/4"	2.0	70	10	8435319135280
641132-02520	25 x 3/4"	2.5	50	5	8435319135297
641132-02620	26 x 3/4"	3.0	50	5	8435319144121
641132-03225	32 x 1"	3.0	30	3	8435319135303



KOMO **DINCERTCO**

TE REDUCIDA
REDUCING TEE

641133

CÓDIGO CODE	MEDIDA SIZE	ESPEJOR THICKNESS			CÓDIGO EAN EAN CODE
641133-01620	16 x 20 x 16	2.0 x 2.0 x 2.0	70	10	8435319135327
641134-01620	20 x 16 x 16	2.0 x 2.0 x 2.0	70	10	8435319135310
641133-02016	20 x 16 x 20	2.0 x 2.0 x 2.0	60	10	8435319135334
641135-02016	20 x 20 x 16	2.0 x 2.0 x 2.0	60	10	8435319135341
641133-02516	25 x 16 x 25	2.5 x 2.0 x 2.5	45	5	8435319135914
641134-02520	25 x 20 x 20	2.5 x 2.0 x 2.0	45	5	8435319135358
641133-02520	25 x 20 x 25	2.5 x 2.0 x 2.5	45	5	8435319135365
641135-02520	25 x 25 x 20	2.5 x 2.5 x 2.0	45	5	8435319135372
641133-02616	26 x 16 x 26	3.0 x 2.0 x 3.0	45	5	8435319135389
641133-02620	26 x 20 x 26	3.0 x 2.0 x 3.0	45	5	8435319135396
641133-03216	32 x 16 x 32	3.0 x 2.0 x 3.0	30	3	8435319135402
641133-03220	32 x 20 x 32	3.0 x 2.0 x 3.0	30	3	8435319135419
641133-03225	32 x 25 x 32	3.0 x 2.5 x 3.0	30	3	8435319135426
641133-03226	32 x 26 x 32	3.0 x 3.0 x 3.0	30	3	8435319135433



KOMO **DINCERTCO**

MANGUITO ACOPLAMIENTO
STRAIGHT COUPLING

641270

CÓDIGO CODE	MEDIDA SIZE	ESPEJOR THICKNESS			CÓDIGO EAN EAN CODE
641270-016	16	2.0	160	10	8435319134818
641270-018	18	2.0	130	10	8435319142851
641270-020	20	2.0	90	10	8435319134825
641270-025	25	2.5	70	5	8435319134832
641270-026	26	3.0	70	5	8435319134849
641270-032	32	3.0	45	5	8435319134856



KOMO **DINCERTCO**

RACOR RECTO HEMBRA
STRAIGHT FEMALE COUPLING

641271

CÓDIGO CODE	MEDIDA SIZE	ESPEJOR THICKNESS			CÓDIGO EAN EAN CODE
641271-01615	16 x 1/2"	2.0	200	10	8435319134993
641271-01620	16 x 3/4"	2.0	160	10	8435319135006
641271-02015	20 x 1/2"	2.0	140	10	8435319135013
641271-02020	20 x 3/4"	2.0	110	10	8435319135020
641271-02520	25 x 3/4"	2.5	80	5	8435319135037
641271-02525	25 x 1"	2.5	75	5	8435319135044
641271-02620	26 x 3/4"	3.0	80	5	8435319135051
641271-02625	26 x 1"	3.0	75	5	8435319135068
641271-03225	32 x 1"	3.0	55	5	8435319135082



KOMO **DINCERTCO**

RACOR RECTO MACHO
STRAIGHT MALE COUPLING

641272

CÓDIGO CODE	MEDIDA SIZE	ESPEJOR THICKNESS			CÓDIGO EAN EAN CODE
641272-01615	16 x 1/2"	2.0	220	10	8435319134870
641272-01620	16 x 3/4"	2.0	180	10	8435319134887
641272-01815	18 x 1/2"	2.0	150	10	8435319142868
641272-02015	20 x 1/2"	2.0	150	10	8435319134894
641272-02020	20 x 3/4"	2.0	120	10	8435319134900
641272-02520	25 x 3/4"	2.5	80	5	8435319134924
641272-02525	25 x 1"	2.5	80	5	8435319134931
641272-02620	26 x 3/4"	3.0	80	5	8435319134948
641272-02625	26 x 1"	3.0	80	5	8435319134955
641272-03225	32 x 1"	3.0	60	3	8435319134979



KOMO DINCERTCO

MANGUITO ACOPLAMIENTO REDUCIDO
REDUCING STRAIGHT COUPLING

641273

CÓDIGO	MEDIDA	ESPEJOR			CÓDIGO EAN
CODE	SIZE	THICKNESS			EAN CODE
641273-02016	20 x 16	2.0 x 2.0	110	10	8435319135105
641273-02520	25 x 20	2.5 x 2.0	80	5	8435319135112
641273-02620	26 x 20	3.0 x 2.0	80	5	8435319144107
641273-03225	32 x 25	3.0 x 2.5	50	5	8435319135129
641273-03226	32 x 26	3.0 x 3.0	50	5	8435319144114



KOMO DINCERTCO

RACOR CODO MURAL
WALL PLATED ELBOW

641500

CÓDIGO	MEDIDA	ESPEJOR			CÓDIGO EAN
CODE	SIZE	THICKNESS			EAN CODE
641500-01615	16 x 1/2"	2.0	100	10	8435319134788
641500-02015	20 x 1/2"	2.0	80	10	8435319134795
641500-02020	20 x 3/4"	2.0	60	10	8435319134801



KOMO

TUBO CORRUGADO EN ROLLO
CORRUGATED PIPE ROLLS

64015

CÓDIGO	MEDIDA INTERIOR	MEDIDA TUBO	METROS	CÓDIGO EAN
CODE	INNER SIZE	PIPE SIZE	METERS	EAN CODE
640151-016*	16	26	50	8435319145623
640152-016**	16	26	50	8435319145654
640151-020*	20	32	50	8435319145630
640152-020**	20	32	50	8435319145661
640151-025*	25	40	50	8435319145647
640152-025**	25	40	50	8435319145678

- Precio por rollo. *Color rojo. **Color azul
Price per roll. *Red colour. **Blue colour



KOMO

TUBO MULTICAPA PERT-AL-PERT AISLADO
ISOLATED MULTILAYER PERT-AL-PERT PIPE

64016

CÓDIGO	MEDIDA	ESPEJOR	METROS	CÓDIGO EAN
CODE	SIZE	THICKNESS	METERS	EAN CODE
640161-016*	16 x 2.0	6mm	50	8435319145708
640162-016**	16 x 2.0	6mm	50	8435319145715
640161-020*	20 x 2.0	6mm	50	8435319145722
640162-020**	20 x 2.0	6mm	50	8435319145739
640161-025*	25 x 2.5	10mm	50	8435319145746
640162-025**	25 x 2.5	10mm	50	8435319145753
640161-026*	26 x 3.0	10mm	50	8435319145760
640162-026**	26 x 3.0	10mm	50	8435319145777
640161-032*	32 x 3.0	10mm	50	8435319145784
640162-032**	32 x 3.0	10mm	50	8435319145791

- Precio por rollo. *Color rojo. **Color azul
Price per roll. *Red colour. **Blue colour



KOMO

TUBO MULTICAPA PERT-AL-PERT EN ROLLO
MULTILAYER PIPE ROLLS PERT-AL-PERT

640R

CÓDIGO	MEDIDA	METROS	CÓDIGO EAN
CODE	SIZE	METERS	EAN CODE
640-015016	16 x 2.0	15	8435319144220
640-025016	16 x 2.0	25	8435319143995
640-100016	16 x 2.0	100	8435319144008
640-100018	18 x 2.0	100	8435319144015
640-015020	20 x 2.0	15	8435319144237
640-025020	20 x 2.0	25	8435319144022
640-100020	20 x 2.0	100	8435319144039
640-015025	25 x 2.5	15	8435319144244
640-025025	25 x 2.5	25	8435319144046
640-050025	25 x 2.5	50	8435319144053
640-025026	26 x 3.0	25	8435319144060
640-050026	26 x 3.0	50	8435319144077
640-025032	32 x 3.0	25	8435319144084
640-050032	32 x 3.0	50	8435319144091

- Precio por rollo
Price per roll



KOMO

TUBO PE-Xa / PE-Xa EVOH EN ROLLO
PE-Xa PIPE / PE-Xa EVOH ROLLS

645

CÓDIGO	MEDIDA	METROS	CÓDIGO EAN
CODE	SIZE	METERS	EAN CODE
645-100016	16 x 2.0	100	8435319145944
645-100116*	16 x 2.0	100	8435319145951
645-100020	20 x 2.0	100	8435319145968
645-100120*	20 x 2.0	100	8435319145975
645-050025	25 x 2.5	50	8435319145982
645-050032	32 x 3.0	50	8435319145999

- Precio por rollo. * Tubo PE-Xa EVOH color rojo
Price per roll. * PE-Xa pipe EVOH red colour



TUBO MULTICAPA PERT-AL-PERT EN BARRA
MULTILAYER PIPE PERT-AL-PERT BAR

640B

CÓDIGO	MEDIDA	METROS	BARRAS / PAQUETE	CÓDIGO EAN
CODE	SIZE	METERS	BARS / BOXES	EAN CODE
640-100416	16 x 2.0	4	25	8435319145876
640-064420	20 x 2.0	4	16	8435319145883
640-040425	25 x 2.5	4	10	8435319145890
640-028432	32 x 3.0	4	7	8435319145906

- Precio por paquete
- Price per boxes

MT GARDEN



LEYENDA DE ICONOS ICON KEY

Posibles codificaciones aplicadas en esta sección.

Possible encodings applied in this section.

Antihielo Nofrost system	Inoxidable Stainless steel	Cierre de Seguridad Locking Device

PROPIEDADES DE PRODUCTO PRODUCT PROPERTIES



LANZA DE RIEGO REGULABLE
QUICK CONNECTOR ADJUSTABLE NOZZLE

4131G

CÓDIGO CODE	MEDIDA SIZE			CÓDIGO EAN EAN CODE
4131-000G	100mm.	60	1	8435319142998



UNIÓN MANGUERA
HOSE TO HOSE CONNECTOR

4134G

CÓDIGO CODE	MEDIDA SIZE			CÓDIGO EAN EAN CODE
4134-015G	15mm.	70	1	8435319143063
4134-019G	19mm.	40	1	8435319143070



ENCHUFE RÁPIDO
QUICK CONNECTOR

4133G

CÓDIGO CODE	MEDIDA SIZE			CÓDIGO EAN EAN CODE
4133-015G	15mm.	70	1	8435319143025
4133-019G	19mm.	50	1	8435319143032



ENCHUFE RÁPIDO CON STOP
QUICK CONNECTOR WITH STOP

41332G

CÓDIGO CODE	MEDIDA SIZE			CÓDIGO EAN EAN CODE
41332-015G	15mm.	70	1	8435319143049
41332-019G	19mm.	50	1	8435319143056



RACOR HEMBRA ENCHUFE RÁPIDO
FEMALE QUICK CONNECTOR

4132G

CÓDIGO CODE	MEDIDA SIZE			CÓDIGO EAN EAN CODE
4132-015G	1/2"	70	1	8435319128459
4132-020G	3/4"	70	1	8435319143001
4132-025G	1"	60	1	8435319143018



RACOR MACHO ENCHUFE RÁPIDO
MALE QUICK CONNECTOR

4135G

CÓDIGO CODE	MEDIDA SIZE			CÓDIGO EAN EAN CODE
4135-015G	1/2"	70	1	8435319145418
4135-020G	3/4"	70	1	8435319145425



DERIVACIÓN DOS SALIDAS
TWO WAY TAP OUTLET

41302G

CÓDIGO CODE	MEDIDA SIZE			CÓDIGO EAN EAN CODE
41302-02020G	3/4" x 3/4" x 3/4"	10	1	8435319134382



DERIVACIÓN TRES SALIDAS
THREE WAY TAP OUTLET

41303G

CÓDIGO CODE	MEDIDA SIZE			CÓDIGO EAN EAN CODE
41303-02020G	3/4" x 3/4" x 3/4" x 3/4"	8	1	8435319134399



GRIFO ESFERA JARDÍN ENCHUFE MANGUERA
PN-16 INOXIDABLE STAINLESS STEEL BIB COCK
GARDEN PN-16 HOSE CONNECTOR

0921G

CÓDIGO CODE	MEDIDA SIZE			CÓDIGO EAN EAN CODE
0921-015G	1/2"	12	1	8435319142882



GRIFO ESFERA JARDÍN ENCHUFE RÁPIDO PN-16
PALANCA CROMADA CON DOS SALIDAS
BRASS BALL BIBCOCK GARDEN TWO OUTLETS
PN-16 CHROME HANDLE WITH QUICK
FEMALE CONNECTOR

4148G

CÓDIGO CODE	MEDIDA SIZE			CÓDIGO EAN EAN CODE
4148-0152020G	1/2" x 3/4" x 3/4"	12	1	8435319142981



GRIFO ESFERA JARDÍN PN-16
ENCHUFE MANGUERA
BRASS BALL BIBCOCK GARDEN PN-16
HOSE CONNECTOR

4111G

CÓDIGO CODE	MEDIDA SIZE			CÓDIGO EAN EAN CODE
4111-01520G	1/2" x 3/4"	12	1	8435319142899
4111-02025G	3/4" x 1"	12	1	8435319142905



GRIFO ESFERA JARDÍN PN-16 CON PALANCA
ACERO INOXIDABLE COLOR NEGRO
Y ENCHUFE RÁPIDO BRASS BALL BIBCOCK
GARDEN PN-16 WITH STAINLESS STEEL BLACK
HANDLE AND QUICK FEMALE CONNECTOR

4123G

CÓDIGO CODE	MEDIDA SIZE			CÓDIGO EAN EAN CODE
4123-01520G	1/2" x 3/4"	12	1	8435319142950



GRIFO JARDÍN DE LATÓN PN-10
ENCHUFE MANGUERA
BRASS BIBCOCK GARDEN PN-10
HOSE CONNECTOR

4145G

CÓDIGO CODE	MEDIDA SIZE			CÓDIGO EAN EAN CODE
4145-01520G	1/2" x 3/4"	20	1	8435319142967



GRIFO ESFERA JARDÍN PN-16 ENCHUFE
MANGUERA PALANCA CROMADA
CON CIERRE DE SEGURIDAD
BRASS BALL BIBCOCK PN-16
HOSE CONNECTOR
CHROME HANDLE LOCKING DEVIC

4147G

CÓDIGO CODE	MEDIDA SIZE			CÓDIGO EAN EAN CODE
4147-01520G	1/2" x 3/4"	12	1	8435319142974

ACCESORIO DE HIERRO MALEABLE GALVANIZADO MALLEABLE GALVANIZED IRON FITTINGS

**LEYENDA DE ICONOS
ICON KEY**

Posibles codificaciones aplicadas en esta sección.

Possible encodings applied in this section.



CERTIFICADOS DE PRODUCTO
PRODUCT CERTIFICATES



**CURVA 90° M-H
M-F LONG SWEEP BEND 90°**



001



CÓDIGO CODE	MEDIDA SIZE		
001-010	3/8"	250	10
001-015	1/2"	180	10
001-020	3/4"	100	10
001-025	1"	40	10
001-032	1 1/4"	20	5
001-040	1 1/2"	20	5
001-050	2"	10	5
001-065	2 1/2"	5	1
001-080	3"	4	1
001-100	4"	1	1

**CURVA 90° H-H
F-F LONG SWEEP BEND 90°**



002



CÓDIGO CODE	MEDIDA SIZE		
002-010	3/8"	250	10
002-015	1/2"	150	10
002-020	3/4"	80	10
002-025	1"	40	10
002-032	1 1/4"	20	5
002-040	1 1/2"	15	5
002-050	2"	10	5
002-065	2 1/2"	5	1
002-080	3"	2	1
002-100	4"	1	1

**CURVA 90° M-M
M-M LONG SWEEP BEND 90°**



003



CÓDIGO CODE	MEDIDA SIZE		
003-015	1/2"	300	10
003-020	3/4"	150	10
003-025	1"	60	10
003-032	1 1/4"	40	5
003-040	1 1/2"	25	5
003-050	2"	10	5

**CURVA 45° M-H
M-F LONG SWEEP BEND 45°**



040



CÓDIGO CODE	MEDIDA SIZE		
040-010	3/8"	300	10
040-015	1/2"	200	10
040-020	3/4"	120	10
040-025	1"	50	10
040-032	1 1/4"	40	5
040-040	1 1/2"	30	5
040-050	2"	15	5
040-065	2 1/2"	10	1
040-080	3"	5	1
040-100	4"	2	1

CURVA 45° H-H
F-F LONG SWEEP BEND 45°

ACS

041



CÓDIGO CODE	MEDIDA SIZE		
041-015	1/2"	200	10
041-020	3/4"	120	10
041-025	1"	50	10
041-032	1 1/4"	40	5
041-040	1 1/2"	30	5
041-050	2"	15	5
041-065	2 1/2"	9	1
041-080	3"	5	1
041-100	4"	2	1

CODO 90° M-H
M-F ELBOW 90°

ACS

092



CÓDIGO CODE	MEDIDA SIZE		
092-008	1/4"	700	10
092-010	3/8"	500	10
092-015	1/2"	250	10
092-020	3/4"	140	10
092-025	1"	80	10
092-032	1 1/4"	55	5
092-040	1 1/2"	30	5
092-050	2"	16	1
092-065	2 1/2"	12	1
092-080	3"	8	1
092-100	4"	4	1

CODO 90° H-H
F-F ELBOW 90°

ACS

090



CÓDIGO CODE	MEDIDA SIZE		
090-008	1/4"	400	10
090-010	3/8"	250	10
090-015	1/2"	250	10
090-020	3/4"	140	10
090-025	1"	80	10
090-032	1 1/4"	40	5
090-040	1 1/2"	30	5
090-050	2"	20	5
090-065	2 1/2"	8	1
090-080	3"	6	1
090-100	4"	3	1

CURVA PUENTE H-H
F-F CROSSOVERS

ACS

085



CÓDIGO CODE	MEDIDA SIZE		
085-015	1/2"	100	10
085-020	3/4"	60	10
085-025	1"	30	10

CODO UNIÓN H-H ASIENTO CÓNICO
F-F UNION ELBOW WITH TAPERED SEAT

ACS

096



CÓDIGO CODE	MEDIDA SIZE		
096-010	3/8"	120	10
096-015	1/2"	100	10
096-020	3/4"	60	10
096-025	1"	40	10
096-032	1 1/4"	30	5
096-040	1 1/2"	20	5
096-050	2"	12	1

CODO 90° REDUCIDO H-H
F-F REDUCING ELBOW 90°

ACS

090R



CÓDIGO CODE	MEDIDA SIZE		
090-01510	1/2" x 3/8"	300	10
090-02015	3/4" x 1/2"	160	10
090-02515	1" x 1/2"	110	10
090-02520	1" x 3/4"	100	10
090-03215	1 1/4" x 1/2"	80	5
090-03220	1 1/4" x 3/4"	70	5
090-03225	1 1/4" x 1"	60	5
090-04015	1 1/2" x 1/2"	60	5
090-04020	1 1/2" x 3/4"	60	5
090-04025	1 1/2" x 1"	40	5
090-04032	1 1/2" x 1 1/4"	40	5
090-05015	2" x 1/2"	40	5
090-05020	2" x 3/4"	40	5
090-05025	2" x 1"	30	5
090-05032	2" x 1 1/4"	30	5
090-05040	2" x 1 1/2"	30	5
090-06540	2 1/2" x 1 1/2"	20	1
090-06550	2 1/2" x 2"	20	1
090-08050	3" x 2"	10	1
090-08065	3" x 2 1/2"	6	1

CODO UNIÓN M-H ASIENTO CÓNICO
M-F ELBOW WITH TAPERED SEAT

ACS

098



CÓDIGO CODE	MEDIDA SIZE		
098-010	3/8"	80	10
098-015	1/2"	80	10
098-020	3/4"	50	10
098-025	1"	30	10
098-032	1 1/4"	20	5
098-040	1 1/2"	15	5
098-050	2"	10	5
098-065	2 1/2"	5	1

CODO TRES BOCAS H
F THREE OUTLETS ELBOW

ACS

221



CÓDIGO CODE	MEDIDA SIZE		
221-015	1/2"	120	10
221-020	3/4"	70	10
221-025	1"	50	10
221-040	1 1/2"	20	5

CODO 45° H-H
F-F ELBOW 45°

ACS

120



CÓDIGO CODE	MEDIDA SIZE		
120-015	1/2"	300	10
120-020	3/4"	180	10
120-025	1"	100	10
120-032	1 1/4"	50	5
120-040	1 1/2"	40	5
120-050	2"	20	5
120-065	2 1/2"	12	1
120-080	3"	6	1
120-100	4"	3	1

CRUZ H
F CROSS

ACS

180



CÓDIGO CODE	MEDIDA SIZE		
180-010	3/8"	110	10
180-015	1/2"	100	10
180-020	3/4"	70	10
180-025	1"	40	10
180-032	1 1/4"	20	5
180-040	1 1/2"	15	5
180-050	2"	10	5
180-065	2 1/2"	6	1
180-080	3"	5	1
180-100	4"	1	1

TE REDUCIDA H
F REDUCING TEE

ACS

130R



CÓDIGO CODE	MEDIDA SIZE		
130-02015	3/4" x 1/2"	120	10
130-02515	1" x 1/2"	60	10
130-02520	1" x 3/4"	60	10
130-03215	1 1/4" x 1/2"	40	5
130-03220	1 1/4" x 3/4"	40	5
130-03225	1 1/4" x 1"	30	5
130-04015	1 1/2" x 1/2"	30	5
130-04020	1 1/2" x 3/4"	30	5
130-04025	1 1/2" x 1"	30	5
130-04032	1 1/2" x 1 1/4"	25	5
130-05015	2" x 1/2"	20	5
130-05020	2" x 3/4"	20	5
130-05025	2" x 1"	20	5
130-05032	2" x 1 1/4"	15	5
130-05040	2" x 1 1/2"	15	5
130-06520	2 1/2" x 3/4"	8	1
130-06525	2 1/2" x 1"	8	1
130-06532	2 1/2" x 1 1/4"	8	1
130-06540	2 1/2" x 1 1/2"	8	1
130-06550	2 1/2" x 2"	8	1
130-08040	3" x 1 1/2"	5	1
130-08050	3" x 2"	5	1
130-08065	3" x 2 1/2"	5	1
130-10050	4" x 2"	4	1
130-10065	4" x 2 1/2"	4	1
130-10080	4" x 3"	4	1

TE IGUAL H
F EQUAL TEE

ACS

130



CÓDIGO CODE	MEDIDA SIZE		
130-008	1/4"	300	10
130-010	3/8"	200	10
130-015	1/2"	150	10
130-020	3/4"	80	10
130-025	1"	50	10
130-032	1 1/4"	30	5
130-040	1 1/2"	20	5
130-050	2"	12	4
130-065	2 1/2"	8	1
130-080	3"	6	1
130-100	4"	3	1

MACHÓN REDUCCIÓN M-M
M-M REDUCING NIPPLE

ACS

245



CÓDIGO CODE	MEDIDA SIZE		
245-00806*	1/4" x 1/8"	800	10
245-01008	3/8" x 1/4"	500	10
245-01508	1/2" x 1/4"	300	10
245-01510	1/2" x 3/8"	200	10
245-02010	3/4" x 3/8"	250	10
245-02015	3/4" x 1/2"	250	10
245-02515	1" x 1/2"	130	10
245-02520	1" x 3/4"	130	10
245-03215	1 1/4" x 1/2"	70	5
245-03220	1 1/4" x 3/4"	70	5
245-03225	1 1/4" x 1"	70	5
245-04020	1 1/2" x 3/4"	60	5
245-04025	1 1/2" x 1"	60	5
245-04032	1 1/2" x 1 1/4"	60	5
245-05025	2" x 1"	30	5
245-05032	2" x 1 1/4"	30	5
245-05040	2" x 1 1/2"	30	5
245-06540	2 1/2" x 1 1/2"	20	1
245-06550	2 1/2" x 2"	20	1
245-08050	3" x 2"	20	1
245-08065	3" x 2 1/2"	20	1
245-10080	4" x 3"	10	1

CODO CUATRO BOCAS H
F ELBOW WITH TWO LATERALS

ACS

223



CÓDIGO CODE	MEDIDA SIZE		
223-015	1/2"	120	10
223-020	3/4"	70	10
223-025	1"	50	10



* Disponible hasta agotar existencias
* While stocks lasts

MANGUITO REDUCCIÓN H-H
F-F REDUCING SOCKET

ACS

240





CÓDIGO CODE	MEDIDA SIZE		
240-01008	3/8" x 1/4"	600	10
240-01508	1/2" x 1/4"	400	10
240-01510	1/2" x 3/8"	400	10
240-02010	3/4" x 3/8"	250	10
240-02015	3/4" x 1/2"	240	10
240-02515	1" x 1/2"	160	10
240-02520	1" x 3/4"	160	10
240-03215	1 1/4" x 1/2"	90	5
240-03220	1 1/4" x 3/4"	90	5
240-03225	1 1/4" x 1"	90	5
240-04015	1 1/2" x 1/2"	80	5
240-04020	1 1/2" x 3/4"	70	5
240-04025	1 1/2" x 1"	60	5
240-04032	1 1/2" x 1 1/4"	50	5
240-05015	2" x 1/2"	50	5
240-05020	2" x 3/4"	50	5
240-05025	2" x 1"	50	5
240-05032	2" x 1 1/4"	40	5
240-05040	2" x 1 1/2"	40	5
240-06515	2 1/2" x 1/2"	22	1
240-06525	2 1/2" x 1"	22	1
240-06532	2 1/2" x 1 1/4"	22	1
240-06540	2 1/2" x 1 1/2"	22	1
240-06550	2 1/2" x 2"	22	1
240-08040	3" x 1 1/2"	18	1
240-08050	3" x 2"	18	1
240-08065	3" x 2 1/2"	18	1
240-10050	4" x 2"	6	1
240-10065	4" x 2 1/2"	6	1
240-10080	4" x 3"	6	1

TUERCA REDUCCIÓN M-H
M-F REDUCING BUSHINGS

ACS

241





CÓDIGO CODE	MEDIDA SIZE		
241-01008	3/8" x 1/4"	1000	10
241-01508	1/2" x 1/4"	800	10
241-01510	1/2" x 3/8"	800	10
241-02008	3/4" x 1/4"	480	10
241-02010	3/4" x 3/8"	480	10
241-02015	3/4" x 1/2"	480	10
241-02508	1" x 1/4"	260	10
241-02510	1" x 3/8"	260	10
241-02515	1" x 1/2"	260	10
241-02520	1" x 3/4"	260	10
241-03215	1 1/4" x 1/2"	160	5
241-03220	1 1/4" x 3/4"	160	5
241-03225	1 1/4" x 1"	160	5
241-04010	1 1/2" x 3/8"	120	5
241-04015	1 1/2" x 1/2"	120	5
241-04020	1 1/2" x 3/4"	120	5
241-04025	1 1/2" x 1"	120	5
241-04032	1 1/2" x 1 1/4"	120	5
241-05015	2" x 1/2"	60	5
241-05020	2" x 3/4"	60	5
241-05025	2" x 1"	60	5
241-05032	2" x 1 1/4"	60	5
241-05040	2" x 1 1/2"	60	5
241-06515	2 1/2" x 1/2"	40	1
241-06520	2 1/2" x 3/4"	40	1
241-06525	2 1/2" x 1"	40	1
241-06532	2 1/2" x 1 1/4"	40	1
241-06540	2 1/2" x 1 1/2"	40	1
241-06550	2 1/2" x 2"	40	1
241-08025	3" x 1"	30	1
241-08032	3" x 1 1/4"	30	1
241-08040	3" x 1 1/2"	30	1
241-08050	3" x 2"	30	1
241-08065	3" x 2 1/2"	30	1
241-10050	4" x 2"	18	1
241-10065	4" x 2 1/2"	18	1
241-10080	4" x 3"	18	1

MANGUITO REDUCCIÓN H-M
F-M REDUCING NIPPLE SOCKET

ACS

246





CÓDIGO CODE	MEDIDA SIZE		
246-01008	3/8" x 1/4"	400	10
246-01508	1/2" x 1/4"	380	10
246-01510	1/2" x 3/8"	380	10
246-02010	3/4" x 3/8"	220	10
246-02015	3/4" x 1/2"	220	10
246-02515	1" x 1/2"	120	10
246-02520	1" x 3/4"	120	10
246-03215	1 1/4" x 1/2"	80	5
246-03220	1 1/4" x 3/4"	80	5
246-03225	1 1/4" x 1"	80	5
246-04020	1 1/2" x 3/4"	60	5
246-04025	1 1/2" x 1"	60	5
246-04032	1 1/2" x 1 1/4"	60	5
246-05025	2" x 1"	30	5
246-05032	2" x 1 1/4"	30	5
246-05040	2" x 1 1/2"	30	5

MANGUITO H-H
F-F SOCKET

ACS

270



CÓDIGO CODE	MEDIDA SIZE		
270-006*	1/8"	700	10
270-008	1/4"	700	10
270-010	3/8"	400	10
270-015	1/2"	340	10
270-020	3/4"	220	10
270-025	1"	120	10
270-032	1 1/4"	60	5
270-040	1 1/2"	50	5
270-050	2"	25	5
270-065	2 1/2"	22	1
270-080	3"	18	1
270-100	4"	6	1

TAPÓN CON REBORDE M
M PLUG BEADED

ACS

290



CÓDIGO CODE	MEDIDA SIZE		
290-006*	1/8"	1000	10
290-008	1/4"	1000	10
290-010	3/8"	1000	10
290-015	1/2"	800	10
290-020	3/4"	400	10
290-025	1"	250	10
290-032	1 1/4"	160	5
290-040	1 1/2"	130	5
290-050	2"	60	5
290-065	2 1/2"	50	1
290-080	3"	26	1
290-100	4"	18	1

- * Disponible hasta agotar existencias
* While stocks lasts

TAPÓN HEXAGONAL H
F HEXAGON CAP

ACS

300



CÓDIGO CODE	MEDIDA SIZE		
300-008	1/4"	800	10
300-010	3/8"	800	10
300-015	1/2"	600	10
300-020	3/4"	400	10
300-025	1"	250	10
300-032	1 1/4"	100	5
300-040	1 1/2"	90	5
300-050	2"	70	5
300-065	2 1/2"	25	1
300-080	3"	18	1
300-100	4"	12	1

BRIDA REDONDA BASE ROSCADA CON TALADROS
F FLOOR FLANGE THREADED BASE WITH HOLES

ACS

321



CÓDIGO CODE	MEDIDA SIZE		
321-015	1/2"	80	10
321-020	3/4"	60	10
321-025	1"	50	10
321-032	1/4"	40	5
321-040	1 1/2"	36	4
321-050	2"	24	4
321-065	2 1/2"	15	1
321-080	3"	10	1
321-100	4"	5	1

- Dimensiones agujeros según EN-1.092-1 PN-6
Dimensiones according EN-1.092-1 PN-6

MACHÓN M-M
M-M HEXAGON NIPPLE

ACS

280



CÓDIGO CODE	MEDIDA SIZE		
280-008	1/4"	500	10
280-010	3/8"	500	10
280-015	1/2"	350	10
280-020	3/4"	250	10
280-025	1"	130	10
280-032	1 1/4"	70	5
280-040	1 1/2"	60	5
280-050	2"	30	5
280-065	2 1/2"	24	1
280-080	3"	18	1
280-100	4"	6	1

TAPÓN H
F ROUND CAP

ACS

301



CÓDIGO CODE	MEDIDA SIZE		
301-010	3/8"	800	10
301-015	1/2"	800	10
301-020	3/4"	400	10
301-025	1"	250	10
301-032	1 1/4"	100	5
301-040	1 1/2"	90	5
301-050	2"	70	5
301-065	2 1/2"	25	1
301-080	3"	18	1
301-100	4"	12	1

TUERCA HEXAGONAL
LOCKNUTS

ACS

312



CÓDIGO CODE	MEDIDA SIZE		
312-010	3/8"	600	10
312-015	1/2"	600	10
312-020	3/4"	400	10
312-025	1"	250	10
312-032	1 1/4"	200	5
312-040	1 1/2"	180	5
312-050	2"	110	5

TUERCA UNIÓN H-H ASIENTO CÓNICO
F-F UNION WITH TAPERED SEAT

ACS

340



CÓDIGO CODE	MEDIDA SIZE		
340-008	1/4"	150	10
340-010	3/8"	150	10
340-015	1/2"	120	10
340-020	3/4"	80	10
340-025	1"	60	10
340-032	1 1/4"	40	5
340-040	1 1/2"	30	5
340-050	2"	20	5
340-065	2 1/2"	10	1
340-080	3"	6	1
340-100	4"	2	1

TUERCA UNIÓN M-H ASIENTO CÓNICO
M-F UNION WITH TAPERED SEAT

ACS

341

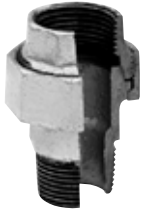

CÓDIGO CODE	MEDIDA SIZE		
341-008	1/4"	150	10
341-010	3/8"	150	10
341-015	1/2"	100	10
341-020	3/4"	60	10
341-025	1"	40	10
341-032	1 1/4"	30	5
341-040	1 1/2"	20	5
341-050	2"	15	5
341-065	2 1/2"	8	1
341-080	3"	6	1
341-100	4"	2	1

MANGUITO M/H
M-F SOCKET

ACS

529



CÓDIGO CODE	MEDIDA SIZE		
529-015	1/2"	360	10
529-020	3/4"	220	10
529-025	1"	120	10
529-032	1 1/4"	80	5
529-040	1 1/2"	60	5
529-050	2"	30	5

VÁLVULAS DE ACERO INOXIDABLE

STAINLESS STEEL VALVES

LEYENDA DE ICONOS ICON KEY

Posibles codificaciones aplicadas en esta sección.

Possible encodings applied in this section.

INOX

Inoxidable
Stainless steel

PROPIEDADES DE PRODUCTO PRODUCT PROPERTIES



VÁLVULA DE DOS PIEZAS ROSCAR H-H MANETA COLOR AZUL F-F BALL VALVE TWO PIECES THREADED END FULL BORE BLUE HANDLE COVER

INOX



0910



CÓDIGO CODE	MEDIDA SIZE		CÓDIGO EAN EAN CODE
0910-008	1/4"	48 24	8435319117705
0910-010	3/8"	48 24	8435319117712
0910-015	1/2"	32 16	8435319117729
0910-020	3/4"	24 12	8435319117736
0910-025	1"	16 8	8435319117743
0910-032	1 1/4"	10 1	8435319117750
0910-040	1 1/2"	10 1	8435319117767
0910-050	2"	6 1	8435319117774
0910-065	2 1/2"	4 1	8435319125601
0910-080	3"	3 1	8435319117798

VÁLVULA DE DOS PIEZAS ROSCAR H-H MANETA COLOR ROJO F-F BALL VALVE TWO PIECES THREADED END FULL BORE RED HANDLE COVER

INOX



09102



CÓDIGO CODE	MEDIDA SIZE		CÓDIGO EAN EAN CODE
09102-008	1/4"	48 24	8435319138052
09102-010	3/8"	48 24	8435319138069
09102-015	1/2"	32 16	8435319138076
09102-020	3/4"	24 12	8435319138083
09102-025	1"	16 8	8435319138090
09102-032	1 1/4"	10 1	8435319138106
09102-040	1 1/2"	10 1	8435319138113
09102-050	2"	6 1	8435319138120
09102-065	2 1/2"	4 1	8435319138137
09102-080	3"	3 1	8435319138144

VÁLVULA DE DOS PIEZAS ROSCAR M-H MANETA COLOR AZUL M-F BALL VALVE TWO PIECES THREADED END FULL BORE BLUE HANDLE COVER

INOX



09103



CÓDIGO CODE	MEDIDA SIZE		CÓDIGO EAN EAN CODE
09103-008	1/4"	48 24	8435319143087
09103-010	3/8"	48 24	8435319143094
09103-015	1/2"	32 16	8435319143100
09103-020	3/4"	24 12	8435319143117
09103-025	1"	16 8	8435319143124
09103-032	1 1/4"	10 1	8435319143131
09103-040	1 1/2"	10 1	8435319143148
09103-050	2"	6 1	8435319143155
09103-065	2 1/2"	4 1	8435319143162
09103-080	3"	3 1	8435319143179
09103-100	4"	2 1	8435319143186

VÁLVULA DE DOS PIEZAS ROSCAR M-H MANETA COLOR ROJO M-F BALL VALVE TWO PIECES THREADED END FULL BORE RED HANDLE COVER

INOX



09104





CÓDIGO CODE	MEDIDA SIZE		CÓDIGO EAN EAN CODE
09104-008	1/4"	48 24	8435319143193
09104-010	3/8"	48 24	8435319143209
09104-015	1/2"	32 16	8435319143216
09104-020	3/4"	24 12	8435319143223
09104-025	1"	16 8	8435319143230
09104-032	1 1/4"	10 1	8435319143247
09104-040	1 1/2"	10 1	8435319143254
09104-050	2"	6 1	8435319143261
09104-065	2 1/2"	4 1	8435319143278
09104-080	3"	3 1	8435319143285
09104-100	4"	2 1	8435319143292

VÁLVULA ESFERA MINI PASO REDUCIDO PN-63 H-H
F-F REDUCED BORE BALL VALVE PN-63

INOX 

0914





CÓDIGO CODE	MEDIDA SIZE			CÓDIGO EAN EAN CODE
0914-008	1/4"	120	60	8435319118016
0914-010	3/8"	120	60	8435319138380
0914-015	1/2"	100	50	8435319138397

VÁLVULA ESFERA MINI PASO REDUCIDO PN-63 M-H
M-F REDUCED BORE BALL VALVE PN-63

INOX 

0915





CÓDIGO CODE	MEDIDA SIZE			CÓDIGO EAN EAN CODE
0915-008	1/4"	120	60	8435319118047
0915-010	3/8"	120	60	8435319118054
0915-015	1/2"	100	50	8435319118061

GRIFO ESFERA JARDÍN ENCHUFE MANGUERA PN-16
INOXIDABLE STAINLESS STEEL BIB COCK GARDEN PN-16
HOSE CONNECTOR

INOX 

0921





CÓDIGO CODE	MEDIDA SIZE			CÓDIGO EAN EAN CODE
0921-015	1/2" x 3/4"	30	15	8435319125854
0921-020	3/4" x 3/4"	20	10	8435319125861
0921-025	1" x 1"	10	5	8435319125878

FILTRO EN Y, A-316 INOXIDABLE CONEXIÓN H-H
F-F STAINLESS STEEL A-316 Y STRAINER

INOX 

0913



CÓDIGO CODE	MEDIDA SIZE			CÓDIGO EAN EAN CODE
0913-008	1/4"	70	35	8435319117576
0913-010	3/8"	70	35	8435319117583
0913-015	1/2"	40	20	8435319117590
0913-020	3/4"	40	20	8435319117606
0913-025	1"	24	12	8435319117613
0913-032	1 1/4"	20	10	8435319117620
0913-040	1 1/2"	12	6	8435319117637
0913-050	2"	6	1	8435319117644

VÁLVULA RETENCIÓN DOS PIEZAS
TWO PIECES SPRING VERTICAL CHECK VALVE

INOX 

0916



CÓDIGO CODE	MEDIDA SIZE			CÓDIGO EAN EAN CODE
0916-008	1/4"	100	50	8435319138403
0916-010	3/8"	100	50	8435319138410
0916-015	1/2"	70	35	8435319138427
0916-020	3/4"	54	27	8435319138434
0916-025	1"	34	17	8435319138441
0916-032	1 1/4"	20	10	8435319138458
0916-040	1 1/2"	20	10	8435319138465
0916-050	2"	12	6	8435319138472
0916-065	2 1/2"	10	5	8435319138489
0916-080	3"	2	1	8435319138496
0916-100	4"	1	1	8435319138502

ACCESORIO INOXIDABLE ROSCADO

STAINLESS STEEL FITTING THREADED



LEYENDA DE ICONOS
ICON KEY

Posibles codificaciones aplicadas en esta sección.

Possible encodings applied in this section.

INOX

Inoxidable
 Stainless steel

PROPIEDADES DE PRODUCTO
PRODUCT PROPERTIES

CODO 90° H-H
F-F ELBOW 90°

INOX

8090



CÓDIGO CODE	MEDIDA SIZE		
8090-008	1/4"	400	10
8090-010	3/8"	300	10
8090-015	1/2"	150	10
8090-020	3/4"	100	10
8090-025	1"	60	5
8090-032	1 1/4"	30	5
8090-040	1 1/2"	25	5
8090-050	2"	10	1
8090-065	2 1/2"	6	1
8090-080	3"	4	1
8090-100	4"	2	1

• Próximamente con código EAN
 Coming soon with EAN code

CODO 45° H-H
F-F ELBOW 45°

INOX

8120



CÓDIGO CODE	MEDIDA SIZE		
8120-008	1/4"	500	10
8120-010	3/8"	250	10
8120-015	1/2"	150	10
8120-020	3/4"	100	10
8120-025	1"	60	5
8120-032	1 1/4"	30	5
8120-040	1 1/2"	30	5
8120-050	2"	15	5

• Próximamente con código EAN
 Coming soon with EAN code

CODO 90° M-H
M-F ELBOW 90°

INOX

8092



CÓDIGO CODE	MEDIDA SIZE		
8092-006	1/8"	500	10
8092-008	1/4"	400	10
8092-010	3/8"	350	10
8092-015	1/2"	150	10
8092-020	3/4"	100	10
8092-025	1"	60	5
8092-032	1 1/4"	30	5
8092-040	1 1/2"	25	5
8092-050	2"	10	5
8092-065	2 1/2"	6	1
8092-080	3"	4	1
8092-100	4"	2	1

• Próximamente con código EAN
 Coming soon with EAN code

TE IGUAL H
F EQUAL TEE

INOX

8130



CÓDIGO CODE	MEDIDA SIZE		
8130-008	1/4"	400	10
8130-010	3/8"	200	10
8130-015	1/2"	100	10
8130-020	3/4"	60	10
8130-025	1"	40	5
8130-032	1 1/4"	20	5
8130-040	1 1/2"	15	5
8130-050	2"	10	1
8130-065	2 1/2"	4	1
8130-080	3"	2	1
8130-100	4"	1	1

• Próximamente con código EAN
 Coming soon with EAN code

CODO 90° H-H REDUCIDO
 F-F REDUCING ELBOW 90°

INOX

80902

CÓDIGO CODE	MEDIDA SIZE		
80902-02015	3/4" x 1/2"	100	10



- Próximamente con código EAN
 Coming soon with EAN code

TE REDUCIDA H
 F REDUCED TEE

INOX

8130R

CÓDIGO CODE	MEDIDA SIZE		
8130-02015	3/4" x 1/2"	60	10



- Próximamente con código EAN
 Coming soon with EAN code

ENTRONQUE R-S DE TUBO
 M WELD NIPPLE FROM TUBING

INOX

8149

CÓDIGO CODE	MEDIDA SIZE		
8149-008	1/4"	1000	10
8149-010	3/8"	600	10
8149-015	1/2"	450	10
8149-020	3/4"	240	10
8149-025	1"	140	5
8149-032	1 1/4"	70	5
8149-040	1 1/2"	60	5
8149-050	2"	36	1
8149-065	2 1/2"	18	1
8149-080	3"	12	1
8149-100	4"	6	1



- Próximamente con código EAN
 Coming soon with EAN code

ENTRONQUE ROSCAR M-M DE TUBO
 M-M PIPE NIPPLE FROM TUBING

INOX

8150

CÓDIGO CODE	MEDIDA SIZE		
8150-008	1/4"	500	10
8150-010	3/8"	400	10
8150-015	1/2"	260	10
8150-020	3/4"	160	10
8150-025	1"	100	5
8150-032	1 1/4"	40	5
8150-040	1 1/2"	40	5
8150-050	2"	24	5



- Próximamente con código EAN
 Coming soon with EAN code

CRUZ
 CROSS

INOX

8180

CÓDIGO CODE	MEDIDA SIZE		
8180-008	1/4"	200	10
8180-010	3/8"	150	10
8180-015	1/2"	80	10
8180-020	3/4"	60	10
8180-025	1"	25	5
8180-032	1 1/4"	20	5
8180-040	1 1/2"	10	5
8180-050	2"	4	1
8180-065	2 1/2"	3	1
8180-080	3"	2	1
8180-100	4"	1	1



- Próximamente con código EAN
 Coming soon with EAN code

MANGUITO REDUCCIÓN H-H
 F-F REDUCED SOCKET

INOX

8240

CÓDIGO CODE	MEDIDA SIZE		
8240-00806	1/4" x 1/8"	600	10
8240-01006	3/8" x 1/8"	500	10
8240-01008	3/8" x 1/4"	500	10
8240-01506	1/2" x 1/8"	350	10
8240-01508	1/2" x 1/4"	350	10
8240-01510	1/2" x 3/8"	350	10
8240-02008	3/4" x 1/4"	300	10
8240-02010	3/4" x 3/8"	300	10
8240-02015	3/4" x 1/2"	300	10
8240-02508	1" x 1/4"	200	5
8240-02510	1" x 3/8"	200	5
8240-02515	1" x 1/2"	200	5
8240-02520	1" x 3/4"	130	5
8240-03215	1 1/4" x 1/2"	100	5
8240-03220	1 1/4" x 3/4"	100	5
8240-03225	1 1/4" x 1"	100	5
8240-04008	1 1/2" x 1/4"	60	5
8240-04010	1 1/2" x 3/8"	60	5
8240-04015	1 1/2" x 1/2"	60	5
8240-04020	1 1/2" x 3/4"	60	5
8240-04025	1 1/2" x 1"	60	5
8240-04032	1 1/2" x 1 1/4"	50	5
8240-05025	2" x 1"	40	1
8240-05032	2" x 1 1/4"	40	1
8240-05040	2" x 1 1/2"	40	1
8240-06525	2 1/2" x 1"	24	1
8240-06532	2 1/2" x 1 1/4"	24	1
8240-06540	2 1/2" x 1 1/2"	24	1
8240-06550	2 1/2" x 2"	24	1



- Próximamente con código EAN
 Coming soon with EAN code

TUERCA REDUCCIÓN M-H
 M-F BUSHING

INOX

8241



CÓDIGO CODE	MEDIDA SIZE		
8241-00806	1/4" x 1/8"	1000	10
8241-01006	3/8" x 1/8"	900	10
8241-01008	3/8" x 1/4"	900	10
8241-01506	1/2" x 1/8"	500	10
8241-01508	1/2" x 1/4"	500	10
8241-01510	1/2" x 3/8"	500	10
8241-02008	3/4" x 1/4"	350	10
8241-02010	3/4" x 3/8"	350	10
8241-02015	3/4" x 1/2"	350	10
8241-02508	1" x 1/4"	220	5
8241-02510	1" x 3/8"	220	5
8241-02515	1" x 1/2"	220	5
8241-02520	1" x 3/4"	220	5
8241-03215	1 1/4" x 1/2"	120	5
8241-03220	1 1/4" x 3/4"	120	5
8241-03225	1 1/4" x 1"	120	5
8241-04010	1 1/2" x 3/8"	90	5
8241-04015	1 1/2" x 1/2"	90	5
8241-04020	1 1/2" x 3/4"	90	5
8241-04025	1 1/2" x 1"	90	5
8241-04032	1 1/2" x 1 1/4"	90	5
8241-05015	2" x 1/2"	60	1
8241-05020	2" x 3/4"	60	1
8241-05025	2" x 1"	60	1
8241-05032	2" x 1 1/4"	60	1
8241-05040	2" x 1 1/2"	60	1
8241-06525	2 1/2" x 1"	24	1
8241-06540	2 1/2" x 1 1/2"	24	1
8241-06550	2 1/2" x 2"	24	1
8241-08040	3" x 1 1/2"	20	1
8241-08050	3" x 2"	20	1
8241-08065	3" x 2 1/2"	20	1
8241-10050	4" x 2"	10	1
8241-10065	4" x 2 1/2"	10	1
8241-10080	4" x 3"	10	1

- Próximamente con código EAN
 Coming soon with EAN code

MANGUITO H-H DE TUBO
 F-F SOCKET FROM TUBING

INOX

8270



CÓDIGO CODE	MEDIDA SIZE		
8270-008	1/4"	600	10
8270-010	3/8"	450	10
8270-015	1/2"	240	10
8270-020	3/4"	200	10
8270-025	1"	100	5
8270-032	1 1/4"	60	5
8270-040	1 1/2"	45	5
8270-050	2"	27	1
8270-065	2 1/2"	12	1
8270-080	3"	12	1
8270-100	4"	4	1

- Próximamente con código EAN
 Coming soon with EAN code

MACHÓN REDUCIDO M-M
 M-M HEXAGON NIPPLE REDUCED

INOX

8245



CÓDIGO CODE	MEDIDA SIZE		
8245-00806	1/4" x 1/8"	800	10
8245-01006	3/8" x 1/8"	650	10
8245-01008	3/8" x 1/4"	650	10
8245-01506	1/2" x 1/8"	400	10
8245-01508	1/2" x 1/4"	400	10
8245-01510	1/2" x 3/8"	400	10
8245-02008	3/4" x 1/4"	300	10
8245-02010	3/4" x 3/8"	300	10
8245-02015	3/4" x 1/2"	300	10
8245-02508	1" x 1/4"	200	5
8245-02510	1" x 3/8"	200	5
8245-02515	1" x 1/2"	200	5
8245-02520	1" x 3/4"	200	5
8245-03215	1 1/4" x 1/2"	100	5
8245-03220	1 1/4" x 3/4"	100	5
8245-03225	1 1/4" x 1"	100	5
8245-04010	1 1/2" x 3/8"	80	5
8245-04015	1 1/2" x 1/2"	80	5
8245-04020	1 1/2" x 3/4"	80	5
8245-04025	1 1/2" x 1"	70	5
8245-04032	1 1/2" x 1 1/4"	50	5
8245-05015	2" x 1/2"	48	1
8245-05020	2" x 3/4"	48	1
8245-05025	2" x 1"	48	1
8245-05032	2" x 1 1/4"	48	1
8245-05040	2" x 1 1/2"	48	1
8245-06550	2 1/2" x 2"	18	1
8245-08050	3" x 2"	18	1
8245-08065	3" x 2 1/2"	18	1

- Próximamente con código EAN
 Coming soon with EAN code

MACHÓN M-M
 M-M HEXAGON NIPPLE

INOX

8280



CÓDIGO CODE	MEDIDA SIZE		
8280-006	1/8"	1000	10
8280-008	1/4"	1000	10
8280-010	3/8"	600	10
8280-015	1/2"	380	10
8280-020	3/4"	200	10
8280-025	1"	140	5
8280-032	1 1/4"	60	5
8280-040	1 1/2"	50	5
8280-050	2"	36	1
8280-065	2 1/2"	18	1
8280-080	3"	12	1
8280-100	4"	4	1

- Próximamente con código EAN
 Coming soon with EAN code

TAPÓN ROSCA M CON REBORDE
 M HEXAGON PLUGS

INOX

8290



CÓDIGO CODE	MEDIDA SIZE		
8290-008	1/4"	800	10
8290-010	3/8"	600	10
8290-015	1/2"	500	10
8290-020	3/4"	300	10
8290-025	1"	200	5
8290-032	1 1/4"	120	5
8290-040	1 1/2"	70	5
8290-050	2"	60	1
8290-065	2 1/2"	24	1
8290-080	3"	20	1
8290-100	4"	8	1

- Próximamente con código EAN
 Coming soon with EAN code

TAPÓN HEXAGONAL H
 F HEXAGON CAP

INOX

8300



CÓDIGO CODE	MEDIDA SIZE		
8300-008	1/4"	1000	10
8300-010	3/8"	800	10
8300-015	1/2"	400	10
8300-020	3/4"	250	10
8300-025	1"	150	5
8300-032	1 1/4"	80	5
8300-040	1 1/2"	70	5
8300-050	2"	40	1
8300-065	2 1/2"	20	1
8300-080	3"	15	1
8300-100	4"	8	1

- Próximamente con código EAN
 Coming soon with EAN code

TUERCA HEXAGONAL
 BACK NUT

INOX

8312



CÓDIGO CODE	MEDIDA SIZE		
8312-008	1/4"	1000	10
8312-010	3/8"	1000	10
8312-015	1/2"	600	10
8312-020	3/4"	500	10
8312-025	1"	300	5
8312-032	1 1/4"	200	5
8312-040	1 1/2"	150	5
8312-050	2"	80	1

- Próximamente con código EAN
 Coming soon with EAN code

ENLACE TRES PIEZAS JUNTA PLANA PTFE H-H
 F-F THREE PIECES UNION PTFE FLAT SEAT

INOX

8330



CÓDIGO CODE	MEDIDA SIZE		
8330-008	1/4"	200	10
8330-010	3/8"	120	10
8330-015	1/2"	100	10
8330-020	3/4"	70	10
8330-025	1"	40	5
8330-032	1 1/4"	30	5
8330-040	1 1/2"	25	5
8330-050	2"	15	1
8330-065	2 1/2"	8	1
8330-080	3"	6	1
8330-100	4"	3	1

- Asiento plano con junta PTFE
 PTFE seat gasket
- Próximamente con código EAN
 Coming soon with EAN code

ENLACE TRES PIEZAS H-H
 F-F THREE PIECES UNION

INOX

8340



CÓDIGO CODE	MEDIDA SIZE		
8340-008	1/4"	200	10
8340-010	3/8"	120	10
8340-015	1/2"	100	10
8340-020	3/4"	70	10
8340-025	1"	40	5
8340-032	1 1/4"	30	5
8340-040	1 1/2"	25	5
8340-050	2"	15	1
8340-065	2 1/2"	8	1
8340-080	3"	6	1
8340-100	4"	3	1

- Asiento cónico
 Tapered seat
- Próximamente con código EAN
 Coming soon with EAN code

ENLACE TRES PIEZAS M-H
 M-F THREE PIECES UNION

INOX

8341



CÓDIGO CODE	MEDIDA SIZE		
8341-008	1/4"	150	10
8341-010	3/8"	120	10
8341-015	1/2"	100	10
8341-020	3/4"	50	10
8341-025	1"	40	5
8341-032	1 1/4"	20	5
8341-040	1 1/2"	15	5
8341-050	2"	10	1
8341-065	2 1/2"	6	1
8341-080	3"	3	1
8341-100	4"	2	1

- Asiento cónico
 Tapered seat
- Próximamente con código EAN
 Coming soon with EAN code

ENTRONQUE MANGUERA
 HEXAGON HOSE NIPPLE

INOX

8399



CÓDIGO CODE	MEDIDA SIZE		
8399-008	1/4" x 9	600	10
8399-010	3/8" x 11,5	500	10
8399-015	1/2" x 15	350	10
8399-020	3/4" x 20	150	10
8399-025	1" x 27	100	5
8399-032	1 1/4" x 33	50	5
8399-040	1 1/2" x 40	30	5
8399-050	2" x 53	20	1

- Próximamente con código EAN
 Coming soon with EAN code

MANGUITO INTERIOR
 RUNNING NIPPLE

INOX

8531



CÓDIGO CODE	MEDIDA SIZE		
8531-008	1/4"	400	10
8531-010	3/8"	400	10
8531-015	1/2"	400	10
8531-020	3/4"	250	10
8531-025	1"	100	5
8531-032	1 1/4"	100	5
8531-040	1 1/2"	80	5
8531-050	2"	20	1
8531-065	2 1/2"	20	1
8531-080	3"	10	1
8531-100	4"	10	1

- Próximamente con código EAN
 Coming soon with EAN code

ENTRONQUE ROSCA MANGUERA
 THREADED HOSE COUPLING

INOX

8601



CÓDIGO CODE	MEDIDA SIZE		
8601-008	1/4"	200	10
8601-010	3/8"	200	10
8601-015	1/2"	200	10
8601-020	3/4"	120	10
8601-025	1"	50	5
8601-032	1 1/4"	40	5
8601-040	1 1/2"	20	5
8601-050	2"	20	1

- Próximamente con código EAN
 Coming soon with EAN code

ENTRONQUE DOBLE MANGUERA
 HOSE COUPLING

INOX

8602



CÓDIGO CODE	MEDIDA SIZE		
8602-008	1/4"	200	10
8602-010	3/8"	200	10
8602-015	1/2"	200	10
8602-020	3/4"	100	10
8602-025	1"	50	5
8602-032	1 1/4"	35	1
8602-040	1 1/2"	25	1
8602-050	2"	25	1

- Próximamente con código EAN
 Coming soon with EAN code

ABARCONES

U-BOLTS



ABARCÓN ACERO AL CARBONO CINCADO

U-BOLT CARBON STEEL GALVANIZED



160101



CÓDIGO CODE	MEDIDA SIZE		CÓDIGO EAN EAN CODE
160101-008	1/4"	600 1	8435319138960
160101-010	3/8"	600 1	8435319138977
160101-015	1/2"	600 1	8435319138984
160101-020	3/4"	600 1	8435319138991
160101-025	1"	600 1	8435319139004
160101-032	1 1/4"	600 1	8435319139011
160101-040	1 1/2"	300 1	8435319139028
160101-050	2"	200 1	8435319139035
160101-065	2 1/2"	150 1	8435319139042
160101-080	3"	125 1	8435319139059
160101-090	3 1/2"	125 1	8435319139066
160101-100	4"	100 1	8435319139073
160101-125	5"	125 1	8435319139080
160101-150	6"	50 1	8435319139097
160101-200	8"	50 1	8435319139103

ABARCÓN ACERO INOXIDABLE

U-BOLT STAINLESS STEEL



160204

AISI 304
(A2)



CÓDIGO CODE	MEDIDA SIZE		CÓDIGO EAN EAN CODE
160204-008	1/4"	100 1	8435319139110
160204-010	3/8"	100 1	8435319139127
160204-015	1/2"	100 1	8435319139134
160204-020	3/4"	100 1	8435319139141
160204-025	1"	100 1	8435319139158
160204-032	1 1/4"	100 1	8435319139165
160204-040	1 1/2"	100 1	8435319139172
160204-050	2"	100 1	8435319139189
160204-065	2 1/2"	50 1	8435319139196
160204-080	3"	50 1	8435319139202
160204-090	3 1/2"	50 1	8435319139219
160204-100	4"	50 1	8435319139226
160204-125	5"	50 1	8435319139233
160204-150	6"	25 1	8435319139240
160204-200	8"	25 1	8435319139257

ABARCÓN ACERO INOXIDABLE

U-BOLT STAINLESS STEEL



160306

AISI 316
(A4)



CÓDIGO CODE	MEDIDA SIZE		CÓDIGO EAN EAN CODE
160306-008	1/4"	100 1	8435319139110
160306-010	3/8"	100 1	8435319139127
160306-015	1/2"	100 1	8435319139134
160306-020	3/4"	100 1	8435319139141
160306-025	1"	100 1	8435319139158
160306-032	1 1/4"	100 1	8435319139165
160306-040	1 1/2"	100 1	8435319139172
160306-050	2"	100 1	8435319139189
160306-065	2 1/2"	50 1	8435319139196
160306-080	3"	50 1	8435319139202
160306-090	3 1/2"	50 1	8435319139219
160306-100	4"	50 1	8435319139226
160306-125	5"	50 1	8435319139233
160306-150	6"	25 1	8435319139240
160306-200	8"	25 1	8435319139257

FICHA TÉCNICA

TECHNICAL DATA SHEET

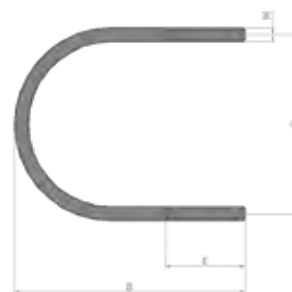

SIZE	B	C	E	M
1/4"	32	20	14	M6
3/8"	37	23,5	15	M6
1/2"	42	28	17	M6
3/4"	50	34	19	M6
1"	62	41	24	M6
1 1/4"	71	49	24	M6
1 1/2"	80	57	26	M8
2"	91	70	26	M8
2 1/2"	117,5	85	35	M10
3"	130,5	101	35	M10
3 1/2"	143	114	35	M10
4"	155	127	35	M10
5"	186	154	40	M10
6"	213	232	40	M10
8"	264	286	40	M10

MANÓMETROS

PRESSURE GAUGES



LEYENDA DE ICONOS ICON KEY

Posibles codificaciones aplicadas en esta sección.

Possible encodings applied in this section.

INOX

Inoxidable
Stainless steel

PROPIEDADES DE PRODUCTO PRODUCT PROPERTIES



MANÓMETRO ESFERA SECA DN50
CONEXIÓN POSTERIOR LATÓN 1/4"
DRY SPHERE PRESSURE GAUGE DN50
BRASS BACK CONNECTION 1/4"

8400

CÓDIGO CODE	BAR	DIAL (BAR)			CÓDIGO EAN EAN CODE
8400-02	0-2,5	0.1	60	1	8435319116128
8400-04	0-4	0.1	60	1	8435319116135
8400-06	0-6	0.1	60	1	8435319116142
8400-10	0-10	0.2	60	1	8435319116159
8400-16	0-16	0.2	60	1	8435319116166



MANÓMETRO ESFERA SECA DN50
CONEXIÓN INFERIOR LATÓN 1/4"
DRY SPHERE PRESSURE GAUGE DN50
BRASS BOTTOM CONNECTION 1/4"

8500

CÓDIGO CODE	BAR	DIAL (BAR)			CÓDIGO EAN EAN CODE
8500-02	0-2,5	0.1	72	1	8435319125588
8500-04	0-4	0.1	72	1	8435319116180
8500-06	0-6	0.1	72	1	8435319116197
8500-10	0-10	0.2	72	1	8435319116203
8500-16	0-16	0.2	72	1	8435319116210



MANÓMETRO ACERO INOXIDABLE GLICERINA
DN63 CONEXIÓN INFERIOR LATÓN 1/4"
STAINLESS STEEL GLYCERINE FILLED
PRESSURE GAUGE DN63 BRASS BOTTOM
CONNECTION 1/4"

8599

CÓDIGO CODE	BAR	DIAL (BAR)			CÓDIGO EAN EAN CODE
8599-02	0-2,5	0.05	54	1	8435319116227
8599-04	0-4	0.1	54	1	8435319116234
8599-06	0-6	0.1	54	1	8435319116241
8599-10	0-10	0.2	54	1	8435319116258
8599-16	0-16	0.2	54	1	8435319116272
8599-25	0-25	0.5	54	1	8435319116289
8599-40	0-40	1.0	54	1	8435319116296
8599-60	0-60	1.0	54	1	8435319116302
8599-100	0-100	2.0	54	1	8435319116265

- Caja acero inoxidable
Stainless steel case



MANÓMETRO ACERO INOXIDABLE GLICERINA
DN100 CONEXIÓN INFERIOR LATÓN 1/2"
STAINLESS STEEL GLYCERINE FILLED PRES-
SURE GAUGE DN100 BRASS
BOTTOM CONNECTION 1/2"

8600

CÓDIGO CODE	BAR	DIAL (BAR)			CÓDIGO EAN EAN CODE
8600-06	0-6	0.1	16	1	8435319116319
8600-10	0-10	0.2	16	1	8435319131138
8600-16	0-16	0.2	16	1	8435319116333
8600-40	0-40	1.0	16	1	8435319116340
8600-100	0-100	2.0	16	1	8435319116326

- Caja acero inoxidable
Stainless steel case

VARIOS OTHERS

LEYENDA DE ICONOS ICON KEY

Posibles codificaciones aplicadas en esta sección.

Possible encodings applied in this section.



CERTIFICADOS DE PRODUCTO
PRODUCT CERTIFICATES



REGULADOR DE NIVEL ELECTROMECÁNICO
ELECTROMECHANICAL FLOAT SWITCHES

KEY

CÓDIGO CODE	MEDIDA SIZE	CÓDIGO EAN EAN CODE
KPM0206KYOC	2 M CABLE PVC 3X1 μ16 (4)	8021989031986
KPM0306KYOC	3 M CABLE PVC 3X1 μ16 (4)	8021989032013
KPM0506KYOC	5 M CABLE PVC 3X1 μ16 (4)	8021989032099

- Contrapeso incluido
Including counterweight



REGULADOR DE NIVEL ELECTROMECÁNICO
ELECTROMECHANICAL FLOAT SWITCHES

MAC3

CÓDIGO CODE	MEDIDA SIZE	CÓDIGO EAN EAN CODE
MPM0206GB0C	2 M CABLE PVC 3X1 μ16 (4)	8021989033171
MPM0306GB0C	3 M CABLE PVC 3X1 μ16 (4)	8021989033218
MPM0506GB0C	5 M CABLE PVC 3X1 μ16 (4)	8021989033263
MPM1006GB0C	10 M CABLE PVC 3X1 μ16 (4)	8021989033386

- Contrapeso incluido
Including counterweight



REGULADOR NIVEL AGUAS RESIDUALES
ELECTROMECHANICAL FLOAT SWITCHES FOR
SEWAGE WATER

MAC5

CÓDIGO CODE	MEDIDA SIZE	CÓDIGO EAN EAN CODE
JPM0506BGO	5 m. CABLE PVC 3X1 μ20(8)	8021989002320
JPM1006BGO	10 m. CABLE PVC 3X1 μ20(8)	8021989002375
JPM2006BGO	20 m. CABLE PVC 3X1 μ20(8)	8021989002429
JPM0506BGO ATEX*	5 m. CABLE PVC 3X1 μ20(8)	8021989037308
JPM1006BGO ATEX*	10 m. CABLE PVC 3X1 μ20(8)	8021989037216

- * ATEX color negro
* ATEX black color
- Aguas sucias
Sewage



REGULADOR NIVEL AGUAS RESIDUALES
ELECTROMECHANICAL FLOAT SWITCHES FOR
SEWAGE WATER

E-FLY

CÓDIGO CODE	MEDIDA SIZE	CÓDIGO EAN EAN CODE
EPM0506B00	5 m. CABLE PVC 3X1 μ20(8)	8021989037520
EPM1006BGO	10 m. CABLE PVC 3X1 μ20(8)	8021989037537
EPM2006BGO	20 m. CABLE PVC 3X1 μ20(8)	8021989037544
EPM5060 ATEX*	5 m. CABLE PVC 3X1 μ20(8)	8021989037797
EPM10060 ATEX*	10 m. CABLE PVC 3X1 μ20(8)	8021989037803

- * ATEX color negro
* ATEX black color
- Aguas sucias
Sewage



REGULADOR HIDRÁULICO DE CIERRE INMEDIATO
INSTANT CLOSURE HYDRAULIC REGULATOR

QUICK STOP

CÓDIGO CODE	MEDIDA SIZE	CÓDIGO EAN EAN CODE
QS0000BR09 *	3/8"	8435319129210
QS0000BR12 *	1/2"	8021989025695
QS0000BR18 **	3/4"	8435319129234
QS0000BR25**	1"	8435319129241
QS0000BR32**	1 1/4"	8435319129258
QS0000BR40**	1 1/2"	8435319129265

- *Blanco/White
** Negro /Black
- Presión máxima 6 BAR
Maximum pressure 6 BAR



VARIADOR DE VELOCIDAD
VARIABLE FREQUENCY DRIVE

E POWER

CÓDIGO CODE	MEDIDA SIZE	CÓDIGO EAN EAN CODE
VEPR1130000	PARA BOMBA MONOFÁSICA FOR SINGLE PHASE PUM 230V 50-60HZ (E-MM08)	8021989038350
VEPR2120000	PARA BOMBA TRIFÁSICA THREE PHASE 230V 50-60HZ (E-MT10)	8021989038466

- Potencia máxima de la bomba monofásica 1,5HP
Maximum power of 1.5 HP for single phase pump
- Potencia máxima de la bomba trifásica 3HP
Maximum power of 3 HP for three phase pumpV



PRESOSTATO PARA SISTEMAS DE PRESURIZACIÓN
PRESSURE SWITCH FOR PRESSURIZATION SYSTEMS

MAC PRESS

CÓDIGO CODE	MEDIDA SIZE	CÓDIGO EAN EAN CODE
VPRM030000	M RANGO/RANGE 1,5-6,0 BAR MONOFÁSICO/SINGLE PHASE	8021989038046
VPRT030000	T RANGO/RANGE 1,5-6,0 BAR TRIFÁSICO/THREE PHASE	8021989033782



REGULADOR DE PRESURIZACIÓN ELECTRÓNICO PARA
BOMBAS ELECTRONIC CONTROL SYSTEM OF ONE PUMP
FOR PRESSURIZATION OF THE WATER

SUPER SIMPLEX E

CÓDIGO CODE	MEDIDA SIZE	CÓDIGO EAN EAN CODE
VSPXE00G00	MOD.E1.5-8 BAR	8021989007899

- Potencia máxima de la bomba 2HP monofásica
Maximum power pump 2HP single phase



VÁLVULA DE BOLA EN PVC PARA ENCOLAR
PVC BALL VALVE SOCKET ENDS

1010

CÓDIGO CODE	MEDIDA SIZE			CÓDIGO EAN EAN CODE
1010-25	25 mm.	40	1	8435319103951
1010-32	32 mm.	40	1	8435319103968
1010-40	40 mm.	16	1	8435319103975
1010-50	50 mm.	16	1	8435319103982
1010-63	63 mm.	10	1	8435319104002
1010-75	75 mm.	3	1	8435319104019
1010-90	90 mm.	3	1	8435319104026

- Presión máxima de trabajo: 10 Bar
Working pressure (Max): 10 Bar



VÁLVULA DE BOLA EN PVC PARA ROSCAR
PVC BALL VALVE THREADED ENDS

101010

CÓDIGO CODE	MEDIDA SIZE			CÓDIGO EAN EAN CODE
101010-25	3/4"	40	1	8435319103876
101010-32	1"	40	1	8435319103883
101010-40	1 1/4"	16	1	8435319103890
101010-50	1 1/2"	16	1	8435319103906
101010-63	2"	10	1	8435319103913
101010-75	2 1/2"	3	1	8435319103920
101010-90	3"	3	1	8435319103937

- Presión máxima de trabajo: 10 Bar
Working pressure (Max): 10 Bar



REDUCTORA DE PRESIÓN "MIGNON"
PRESSURE REDUCING VALVE "MIGNON"

4150

CÓDIGO CODE	MEDIDA SIZE			CÓDIGO EAN EAN CODE
4150-015	1/2"	50	1	8435319115893
4150-020	3/4"	50	1	8435319115909

- Presión máxima de entrada 15 Bar / Latón DZR opcional
Maximum admission pressure 15 Bar / Optional in brass DZR



REDUCTORA DE PRESIÓN CON BRIDAS
PRESSURE REDUCING VALVE FLANGED ENDS

4153

CÓDIGO CODE	MEDIDA SIZE			CÓDIGO EAN EAN CODE
4153-050	2"	2	1	8435319140437
4153-065	2 1/2"	2	1	8435319140420

- Presión máxima de entrada 25 Bar / Latón DZR opcional
Maximum admission pressure 25 Bar / Optional in brass DZR



REDUCTORA DE PRESIÓN
PRESSURE REDUCING VALVE

4151

CÓDIGO CODE	MEDIDA SIZE			CÓDIGO EAN EAN CODE
4151-015	1/2"	30	1	8435319115916
4151-020	3/4"	30	1	8435319115923
4151-025	1"	15	1	8435319115930
4151-032	1 1/4"	6	1	8435319115947
4151-040	1 1/2"	6	1	8435319115954
4151-050	2"	3	1	8435319115961
4151-065	2 1/2"	3	1	8435319115978
4151-080	3"	3	1	8435319115985

- Presión máxima de entrada 25 Bar / Latón DZR opcional
Maximum admission pressure 25 Bar / Optional in brass DZR



REDUCTORA DE PRESIÓN CON RACORES
PRESSURE REDUCING VALVE WITH RACORDS

4152

CÓDIGO CODE	MEDIDA SIZE			CÓDIGO EAN EAN CODE
4152-015	1/2"	20	1	8435319115992
4152-020	3/4"	10	1	8435319116005
4152-025	1"	10	1	8435319116012
4152-032	1 1/4"	6	1	8435319116029
4152-040	1 1/2"	6	1	8435319116036
4152-050	2"	3	1	8435319116043

- Presión máxima de entrada 25 Bar / Latón DZR opcional
Maximum admission pressure 25 Bar / Optional in brass DZR



REDUCTORA DE PRESIÓN CON GRADUACIÓN
PRESSURE REDUCING VALVE
WITH GRADUATED SETTING

4154

CÓDIGO CODE	MEDIDA SIZE			CÓDIGO EAN EAN CODE
4154-015	1/2"	15	1	8435319145562
4154-020	3/4"	15	1	8435319145579
4154-025	1"	10	1	8435319145586

- Presión máxima de entrada 25 Bar
Maximum admission pressure 25 Bar



REDUCTORA DE PRESIÓN CON RACORS Y GRADUACIÓN
PRESSURE REDUCING VALVE
WITH RACORDS AND GRADUATED SETTINGS

4155

CÓDIGO CODE	MEDIDA SIZE			CÓDIGO EAN EAN CODE
4155-015	1/2"	15	1	8435319145593
4155-020	3/4"	10	1	8435319145609
4155-025	1"	10	1	8435319145616

- Presión máxima de entrada 25 Bar
Maximum admission pressure 25 Bar



FILTRO Y DISPOSITIVO ANTIREFLUJO (TAMIZ DE 100µ)
FILTERS AND BACKFLOW PREVENTER (100µ)

4160

CÓDIGO CODE	MEDIDA SIZE			CÓDIGO EAN EAN CODE
4160-015	1/2"	20	1	8435319116050
4160-020	3/4"	20	1	8435319116067
4160-025	1"	18	1	8435319116074
4160-032	1 1/4"	10	1	8435319116081
4160-040	1 1/2"	10	1	8435319116098
4160-050	2"	6	1	8435319116104



AMORTIGUADOR GOLPE DE ARIETE
WATER HAMMER ARRESTOR

4161

CÓDIGO CODE	MEDIDA SIZE			CÓDIGO EAN EAN CODE
4161-015	1/2"	20	1	8435319116111

- Hasta tubería de 50mm.
Up to 50mm. pipe



DETECTOR Y DISYUNTOR DE FUGAS DE AGUA
WATER LEAKAGE DETECTOR AND CIRCUIT BREAKER

STOP FLOW

CÓDIGO CODE		CÓDIGO EAN EAN CODE
STF20	1	3760134100263
STFCO*	1	3760134100270

- Conexión wifi
Wifi connection

- EN CASO DE FUGA O ROTURA DE UNA TUBERÍA, LA VÁLVULA CIERRA EL SUMINISTRO DE AGUA Y SE ENVÍA UNA NOTIFICACIÓN INMEDIATA.
- EL AGUA SE RESTABLECE SIMPLEMENTE PULSANDO EL BOTÓN "ON" SOBRE LA CARCASA DE LA VÁLVULA.
- DESDE LA APLICACIÓN, CIERRE EL AGUA DE SU CASA A DISTANCIA EN TIEMPO REAL..
- PUEDES SUPERVISAR SU CONSUMO DE AGUA (POR MES, POR SEMANA, POR DÍA O POR HORA) Y HACER UN SEGUIMIENTO DE SU AHORRO.
- CAPACIDAD DE MONITOREAR/ADMINISTRAR MÚLTIPLES SITIOS DESDE UN PORTAL WEB.
- UNA APLICACIÓN EFICIENTE Y FÁCIL DE USAR DISPONIBLE DE FORMA GRATUITA EN IOS Y ANDROID.

INSTALACIÓN

- Ubicación al contador tan cercana como sea posible.
- Protección: IP67.
- Conexión 3/4" salida macho-macho.

DATOS TÉCNICOS

- Sin conexión eléctrica.
- Suministro de batería de 3V.
- Peso: 1,75Kg
- Distancia central 110mm.

PARÁMETROS	FLUYE ENTRE	VOLUMEN	TIEMPO DE INTERRUPCIÓN
FUGA GRANDE	501 L/H y 800 L/H	80 L	< 7 min.
FUGA MEDIANA	201 L/H y 500 L/H	35 L y 80 L	Entre 14 min. y 7 min.
FUGA PEQUEÑA	3 L/H y 200 L/H	35 L	> 14 min.

NEW



FILTRO MAGNÉTICO
MAGNETIC STRAINER

4156

CÓDIGO CODE	MEDIDA SIZE			CÓDIGO EAN EAN CODE
4156-020	3/4"	50	1	8435319146118
4156-025	1"	50	1	8435319146125

NEW



FILTRO DESFANGADOR MAGNÉTICO
MAGNETIC DIRT SEPARATOR STRAINER

4157

CÓDIGO CODE	MEDIDA SIZE			CÓDIGO EAN EAN CODE
4157-020	3/4"	5	1	8435319146323



EL DESFANGADOR CONTIENE:

- Tamiz filtrante de 800 micras (0.8mm)
- Imán extraíble de 12.000 Gauss
- Válvula M-H de 3/4", enlace 3/4" (racor loco) y tapón 3/4" en latón

CONDICIONES DE TRABAJO:

- Presión máxima de funcionamiento de 10bar
- Temperatura de funcionamiento de 110°C

CARACTERÍSTICAS:

- Roscas según ISO 228
- Ideal para instalación en lugares con limitaciones de espacio.
- Fácil desmontaje del tamiz para su limpieza.
- Con la instalación de una válvula en el tapón se puede limpiar las impurezas del desfangador sin parar el circuito.

APLICACIONES:

- Instalaciones de calefacción con calderas de gas, gasoil y biomasa.
- Instalaciones de calor y frío con bomba de calor de aerotermia y geotermia.
- Instalaciones de suministro de agua y glicol.

- SEPARA Y ELIMINA LAS IMPUREZAS DE LOS CIRCUITOS CERRADOS
- EL IMÁN INTERIOR RETIENE LAS IMPUREZAS FÉRRICAS



Impulsión



Retorno



Impulsión



Retorno



Impulsión

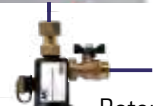

Retorno



FLEXO DE DUCHA EN ACERO INOXIDABLE
DOBLE ENGATILLADO
SHOWER STAINLESS STEEL HOSE DOUBLE CLIP

600

CÓDIGO	MEDIDA			CÓDIGO EAN
CODE	SIZE			EAN CODE
600-02	1/2"	50	1	8435319116531

- Longitud 170-210mm.
Length 170-210mm.



FLEXO DE DUCHA EN ACERO INOXIDABLE
DOBLE ENGATILLADO CONECTORES PLÁSTICO
SHOWER STAINLESS STEEL HOSE DOUBLE CLIP
PLASTIC CONECTORS

6002

CÓDIGO	MEDIDA			CÓDIGO EAN
CODE	SIZE			EAN CODE
6002-02	1/2"	50	1	8435319131152

- Longitud 170-210mm.
Length 170-210mm.



FLEXO DE DUCHA FLEXIBLE PVC
FLEXIBLE PVC SHOWER HOSE

601

CÓDIGO	MEDIDA			CÓDIGO EAN
CODE	SIZE			EAN CODE
601-02	1/2"	40	1	8435319147436

- Longitud 175mm.
Length 175mm.



VÁLVULA DE LLENADO ALIMENTACIÓN MIXTA
MIXED FILL VALVE

55007

CÓDIGO CODE	MEDIDA SIZE			CÓDIGO EAN EAN CODE
55007	3/8"	24	1	8435319134375



VÁLVULA DE LLENADO ALIMENTACIÓN INFERIOR
BOTTOM FILL VALVE

55002

CÓDIGO CODE	MEDIDA SIZE			CÓDIGO EAN EAN CODE
55002	3/8"	25	1	8435319131381



VÁLVULA DE LLENADO ALIMENTACIÓN LATERAL
SIDE FILL VALVE

55003

CÓDIGO CODE	MEDIDA SIZE			CÓDIGO EAN EAN CODE
55003	3/8"	24	1	8435319131398

EXPOSITOR PRESENTACIÓN DE SOBREMESA
PRESENTATION DISPLAY EXHIBITOR

Exclusivo expositor para poder ofrecer una mejor presentación en sus válvulas de llenado y descarga

Exclusive exhibitor can be offered together with flush and fill valves for better presentation

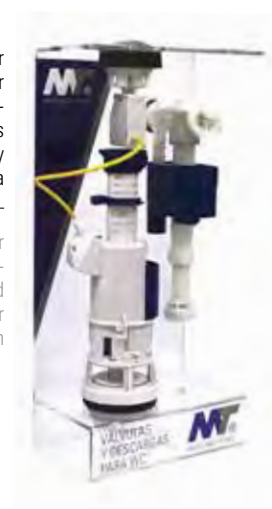

VÁLVULA DE DESCARGA DE DOBLE PULSADOR CON CABLE
CABLE DUAL FLUSH VALVE

55001

CÓDIGO CODE	MEDIDA SIZE			CÓDIGO EAN EAN CODE
55001	2"	25	1	8435319131374

- Tornillos de fijación incluidos
Tank fastening screws included



VÁLVULA DE DESCARGA DE PULSADOR SIMPLE
SINGLE FLUSH VALVE

55004

CÓDIGO CODE	MEDIDA SIZE			CÓDIGO EAN EAN CODE
55004	2"	25	1	8435319131558

- Tornillos de fijación incluidos
Tank fastening screws included



VÁLVULA DE DESCARGA DE DOBLE PULSADOR CON CABLE ADAPTADOR UNIVERSAL
CABLE DUAL FLUSH VALVE UNIVERSAL ADAPTOR

55005

CÓDIGO CODE	MEDIDA SIZE			CÓDIGO EAN EAN CODE
55005	2"	20	1	8435319131572

- Tornillos de fijación incluidos
Tank fastening screws included



VÁLVULA DE DESCARGA DE DOBLE PULSADOR
DUAL FLUSH VALVE

55006

CÓDIGO CODE	MEDIDA SIZE			CÓDIGO EAN EAN CODE
55006	2"	25	1	8435319133934

- Tornillos de fijación incluidos
Tank fastening screws included
- Compatible con las principales marcas de sanitarios
Suitable for the main sanitary brands



THF ALTA PRESIÓN ULTRARÁPIDO
THF ULTRAFAST HIGH PRESSURE

THF ALTA PRESIÓN

CÓDIGO CODE	PRODUCTO PRODUCT		CÓDIGO EAN EAN CODE
IT00101	TUBO 125 ml.	25	8436023350044
IT00103	BOTE 500 ml.	24	8436023350020
IT00104	BOTE 500 ml. + PINCEL	24	8436023350037
IT00105	BOTE 1.000 ml.	12	8436023350006
IT00106	BOTE 1.000 ml. + PINCEL	12	8436023350013

- Tiempo de secado 30 segundos
• 30 secons dry
- Adhesivo PVC
• PVC cement



N-30 "PRESIÓN" SECADO RÁPIDO
N-30 'PRESSURE' FAST CURING

N-30 SECADO RÁPIDO

CÓDIGO CODE	PRODUCTO PRODUCT		CÓDIGO EAN EAN CODE
IT00301	TUBO 125 ml.	25	8436023350105
IT00302	BOTE 250 ml. + PINCEL	24	8436023350099
IT00304	BOTE 500 ml. + PINCEL	24	8436023350082
IT00306	BOTE 1.000 ml. + PINCEL	12	8436023350068

- Tiempo de secado 90 segundos
• 90 secons dry
- Adhesivo PVC
• PVC cement



N-40 "PRESIÓN" SECADO LENTO
N-40 'PRESSURE' SLOW CURING

N-40 SECADO LENTO

CÓDIGO CODE	PRODUCTO PRODUCT		CÓDIGO EAN EAN CODE
IT00401	TUBO 125 ml.	25	8436023350150
IT00404	BOTE 500 ml. + PINCEL	24	8436023350143
IT00406	BOTE 1.000 ml. + PINCEL	12	8436023350129

- Tiempo de secado 180 segundos
• 180 secons dry
- Adhesivo PVC
• PVC cement



BLUETITE ADHESIVO PVC FLEXIBLE
BLUETITE SOLVENT CEMENT PVC FLEXIBLE

BLUETITE PVC FLEXIBLE

CÓDIGO CODE	PRODUCTO PRODUCT		CÓDIGO EAN EAN CODE
IT00201	TUBO 125 ml.	25	8436023350808
IT00202	BOTE 250 ml. + PINCEL	24	8436023350167
IT00204	BOTE 500 ml. + PINCEL	24	8436023350334
IT00206	BOTE 1.000 ml. + PINCEL	12	8436023350679

- Adhesivo PVC
• PVC cement



LN-40 LIMPIADOR PARA PVC (DECAPANTE)
LN-40 CLEANER FOR PVC (STRIPPER)

LN-40

CÓDIGO CODE	PRODUCTO PRODUCT		CÓDIGO EAN EAN CODE
IT00802LNP*	BOTE 250 ml.	24	8436023350860
IT00803LN	BOTE 500 ml.	24	8436023350204
IT00805LN	BOTE 1.000 ml.	12	8436023350198

- Formato de plástico
• Plastic format



LIMPIADOR PARA POLIETILENO
POLYETHYLENE CLEANER

LIMPIADOR

CÓDIGO CODE	PRODUCTO PRODUCT		CÓDIGO EAN EAN CODE
IT00805IPA	BOTE 1.000 ml.	12	8436023350846



PTFE LÍQUIDO
LIQUID PTFE

PTFE LÍQUIDO

CÓDIGO	PRODUCTO		CÓDIGO EAN
CODE	PRODUCT		EAN CODE
IT013L75	75 ml.	12	8436023350358

- Sellado de roscas en fontanería
- Threaded seal in plumbing



WRAS



CINTA DE PTFE
PTFE TAPE

CINTA PTFE

CÓDIGO	PRODUCTO		CÓDIGO EAN
CODE	PRODUCT		EAN CODE
700-10	12 x 12 x 0,075	1000	8435319116494
700-11	12 x 12 x 0,10	1000	8435319116500
700-12	25 x 15 x 0,10	250	8435319116517
700-13	50 x 19 x 0,10	250	8435319116524



DESATASCADOR
DRAIN CLEANER

DESATASCADOR

CÓDIGO	PRODUCTO		CÓDIGO EAN
CODE	PRODUCT		EAN CODE
IT00803DES	500 ml.	24	8436023350914
IT00805DES	1.000 ml.	12	8436023350471



SELLADOR HIDRÁULICO BAJA RESISTENCIA
HYDRAULIC SEALANT

SELLADOR

CÓDIGO	PRODUCTO		CÓDIGO EAN
CODE	PRODUCT		EAN CODE
IT019142	50 ml.	10	8436023350761



CIANOCRILATO
CYANOACRYLATE

CIANOCRILATO

CÓDIGO	PRODUCTO		CÓDIGO EAN
CODE	PRODUCT		EAN CODE
IT019C	20 cc.	12	8436023350723

CONEXIÓN FLEXIBLE

FLEXIBLE CONNECTION



LEYENDA DE ICONOS
ICON KEY

AENOR



CERTIFICADOS DE PRODUCTO
PRODUCT CERTIFICATES



AENOR

CONEXIÓN FLEXIBLE "LATIGUILLO" DN8
H-H ACERO INOXIDABLE F-F FLEXIBLE DN8
STAINLESS STEEL CONNECTION

170821010

CÓDIGO CODE	MEDIDA SIZE	LONGITUD LENGHT			CÓDIGO EAN EAN CODE
170821010-0150	3/8" x 3/8"	150 mm.	150	10	8435319148594
170821010-0200	3/8" x 3/8"	200 mm.	100	10	8435319148600
170821010-0250	3/8" x 3/8"	250 mm.	80	10	8435319148617
170821010-0300	3/8" x 3/8"	300 mm.	100	10	8435319148624
170821010-0350	3/8" x 3/8"	350 mm.	100	10	8435319148631
170821010-0400	3/8" x 3/8"	400 mm.	120	10	8435319148648
170821010-0450	3/8" x 3/8"	450 mm.	100	10	8435319148655
170821010-0500	3/8" x 3/8"	500 mm.	100	10	8435319148662
170821010-0600	3/8" x 3/8"	600 mm.	100	10	8435319148679
170821010-0800	3/8" x 3/8"	800 mm.	100	10	8435319148686
170821010-1000	3/8" x 3/8"	1000 mm.	50	10	8435319148693



AENOR

CONEXIÓN FLEXIBLE "LATIGUILLO" DN8
H-H ACERO INOXIDABLE F-F FLEXIBLE DN8
STAINLESS STEEL CONNECTION

170821015

CÓDIGO CODE	MEDIDA SIZE	LONGITUD LENGHT			CÓDIGO EAN EAN CODE
170821015-0150	3/8" x 1/2"	150 mm.	150	10	8435319148907
170821015-0200	3/8" X 1/2"	200 mm.	100	10	8435319148914
170821015-0250	3/8" x 1/2"	250 mm.	80	10	8435319148921
170821015-0300	3/8" x 1/2"	300 mm.	100	10	8435319149102
170821015-0350	3/8" x 1/2"	350 mm.	100	10	8435319149119
170821015-0400	3/8" X 1/2"	400 mm.	120	10	8435319149126
170821015-0500	3/8" x 1/2"	500 mm.	100	10	8435319149140
170821015-0600	3/8" X 1/2"	600 mm.	100	10	8435319149157
170821015-0800	3/8" X 1/2"	800 mm.	100	10	8435319149164
170821015-1000	3/8" x 1/2"	1000 mm.	50	10	8435319149171



AENOR

CONEXIÓN FLEXIBLE "LATIGUILLO" DN8
H-H ACERO INOXIDABLE F-F FLEXIBLE DN8
STAINLESS STEEL CONNECTION

170821515

CÓDIGO CODE	MEDIDA SIZE	LONGITUD LENGHT			CÓDIGO EAN EAN CODE
170821515-0150	1/2" x 1/2"	150 mm.	150	10	8435319148839
170821515-0200	1/2" x 1/2"	200 mm.	80	10	8435319148846
170821515-0250	1/2" X 1/2"	250 mm.	80	10	8435319148853
170821515-0300	1/2" x 1/2"	300 mm.	100	10	8435319148860
170821515-0350	1/2" x 1/2"	350 mm.	80	10	8435319148877
170821515-0400	1/2" x 1/2"	400 mm.	120	10	8435319148884
170821515-0450	1/2" x 1/2"	450 mm.	100	10	8435319148891
170821515-0500	1/2" x 1/2"	500 mm.	100	10	8435319148907
170821515-0600	1/2" x 1/2"	600 mm.	100	10	8435319148914
170821515-0800	1/2" x 1/2"	800 mm.	100	10	8435319148921
170821515-1000	1/2" X 1/2"	1000 mm.	50	10	8435319148938



AENOR

CONEXIÓN FLEXIBLE "LATIGUILLO" DN8
M-H ACERO INOXIDABLE M-F FLEXIBLE DN8
STAINLESS STEEL CONNECTION

170811010

CÓDIGO CODE	MEDIDA SIZE	LONGITUD LENGHT			CÓDIGO EAN EAN CODE
170811010-0150	3/8" x 3/8"	150 mm.	150	10	8435319148716
170811010-0200	3/8" x 3/8"	200 mm.	100	10	8435319148723
170811010-0250	3/8" x 3/8"	250 mm.	80	10	8435319148730
170811010-0300	3/8" x 3/8"	300 mm.	100	10	8435319148747
170811010-0350	3/8" x 3/8"	350 mm.	100	10	8435319148754
170811010-0400	3/8" x 3/8"	400 mm.	120	10	8435319148761
170811010-0500	3/8" x 3/8"	500 mm.	100	10	8435319148785
170811010-0600	3/8" x 3/8"	600 mm.	100	10	8435319148792
170811010-0800	3/8" x 3/8"	800 mm.	100	10	8435319148808
170811010-1000	3/8" x 3/8"	1000 mm.	50	10	8435319148815



NEW

CONEXIÓN FLEXIBLE "LATIGUILLO" DN8
M-H ACERO INOXIDABLE M-F FLEXIBLE DN8
STAINLESS STEEL CONNECTION

170811015

CÓDIGO CODE	MEDIDA SIZE	LONGITUD LENGHT			CÓDIGO EAN EAN CODE
170811015-0150	3/8" x 1/2"	150 mm.	150	10	8435319149317
170811015-0200	3/8" x 1/2"	200 mm.	100	10	8435319149324
170811015-0250	3/8" x 1/2"	250 mm.	80	10	8435319149331
170811015-0300	3/8" x 1/2"	300 mm.	100	10	8435319149348
170811015-0350	3/8" x 1/2"	350 mm.	100	10	8435319149355
170811015-0400	3/8" x 1/2"	400 mm.	120	10	8435319149362
170811015-0500	3/8" x 1/2"	500 mm.	100	10	8435319149218
170811015-0600	3/8" x 1/2"	600 mm.	100	10	8435319149393
170811015-0800	3/8" x 1/2"	800 mm.	100	10	8435319149232
170811015-1000	3/8" x 1/2"	1000 mm.	50	10	8435319149249

- Rosca macho 3/8"
Male threaded 3/8"
- Rosca hembra 1/2"
Female threaded 1/2"



NEW

CONEXIÓN FLEXIBLE "LATIGUILLO" DN8
M-H ACERO INOXIDABLE M-F FLEXIBLE DN8
STAINLESS STEEL CONNECTION

170811510

CÓDIGO CODE	MEDIDA SIZE	LONGITUD LENGHT			CÓDIGO EAN EAN CODE
170811510-0150	1/2" x 3/8"	150 mm.	150	10	8435319149195
170811510-0200	1/2" x 3/8"	200 mm.	100	10	8435319149201
170811510-0250	1/2" x 3/8"	250 mm.	80	10	8435319149218
170811510-0300	1/2" x 3/8"	300 mm.	100	10	8435319149225
170811510-0350	1/2" x 3/8"	350 mm.	100	10	8435319149232
170811510-0400	1/2" x 3/8"	400 mm.	120	10	8435319149249
170811510-0450	1/2" x 3/8"	450 mm.	100	10	8435319149256
170811510-0500	1/2" x 3/8"	500 mm.	100	10	8435319149263
170811510-0600	1/2" x 3/8"	600 mm.	100	10	8435319149102
170811510-0800	1/2" x 3/8"	800 mm.	100	10	8435319149119
170811510-1000	1/2" x 3/8"	1000 mm.	50	10	8435319149126

- Rosca macho 1/2"
Male threaded 1/2"
- Rosca hembra 3/8"
Female threaded 3/8"



NEW

CONEXIÓN FLEXIBLE "LATIGUILLO" DN8
M-H ACERO INOXIDABLE M-F FLEXIBLE DN8
STAINLESS STEEL CONNECTION

170811515

CÓDIGO CODE	MEDIDA SIZE	LONGITUD LENGHT			CÓDIGO EAN EAN CODE
170811515-0150	1/2" x 1/2"	150 mm.	150	10	8435319148952
170811515-0200	1/2" x 1/2"	200 mm.	80	10	8435319148969
170811515-0250	1/2" x 1/2"	250 mm.	80	10	8435319148976
170811515-0300	1/2" x 1/2"	300 mm.	100	10	8435319148983
170811515-0350	1/2" x 1/2"	350 mm.	80	10	8435319148990
170811515-0400	1/2" x 1/2"	400 mm.	120	10	8435319149003
170811515-0450	1/2" x 1/2"	450 mm.	100	10	8435319149010
170811515-0500	1/2" x 1/2"	500 mm.	100	10	8435319149027
170811515-0600	1/2" x 1/2"	600 mm.	100	10	8435319149034
170811515-0800	1/2" x 1/2"	800 mm.	100	10	8435319149041
170811515-1000	1/2" x 1/2"	1000 mm.	50	10	8435319149058

CONDICIONES DE VENTA

TERMS & CONDITIONS

CONDICIONES VÁLIDAS SÓLO PARA ESPAÑA VALID CONDITIONS ONLY IN SPAIN

PRECIOS Y CONDICIONES DE PAGO

Contado: reposición o recibo a 15 días dto. P.P. 1%.

Forma de pago: plazo máximo 60 días fecha factura.

IVA: se cargará el % correspondiente, según reglamentación en vigor.

Tarifas de precios: nos comprometemos a comunicar a nuestros clientes cualquier cambio que se produzca en las tarifas del catálogo a través de las usuales vías de comunicación: web, email, correo.

PEDIDOS

Con el fin de evitar confusiones y ofrecer un mejor servicio, será condición indispensable por parte del comprador indicar la referencia MT Business Key, S.L. en su pedido, incluidos los dígitos de la medida. Cada pedido enviado a MT Business Key, S.L. genera una expedición para el cliente, recomendamos que preparen sus pedidos completos para optimizar los gastos de transporte. Todos los pedidos serán confirmados vía email y, salvo notificación de lo contrario, seguirá su curso sin derecho a posteriores modificaciones.

Pedido mínimo aceptable: 150€ netos.

Cantidades mínimas: las cantidades mínimas aceptables corresponderán a las del embalaje interior de la caja.

Embalajes: incluidos.

PORTES

Se cargarán 7€ en factura para pedidos inferiores a los 400 € netos (Península y Baleares). Para el resto del territorio se cargarán los portes en factura aplicando la tarifa reducida de nuestra agencia de transportes.

España (Península) e Islas Baleares: incluidos en pedidos superiores a 400€ netos.

Melilla: incluidos en pedidos superiores a 1200€ netos.

Islas Canarias: incluidos en pedidos superiores a 800€ netos.

CONDICIONES VÁLIDAS SÓLO PARA EXPORTACIÓN VALID CONDITIONS ONLY FOR EXPORT

RATES AND FREIGHTS CONDITIONS

Cash: bank transfer. For advance payments discount 1%.

Credit: max. 60 days invoice date after Bank Insurance Approval.

Freight Conditions: EXW Incoterms 2010, unless other conditions are granted.

Price rates: MT Business Key, S.L. commits to communicate to our customers any changes applied on tariffs through usual means of communication: web & email.

ORDERS

Minimum order amount: 500€ netto.

Minimum quantities: the minimum acceptable quantities will be equal to inner packing quantities.

Packing: included.

COSTUMER SERVICE

Claims: all claims will be granted within 45 days after date of Invoice. After this period MT Business Key, S.L. can't promise any resolution.

Warranty: all our products are new and are covered for 2 years.

Return policy: all material returned will be at freight paid. All products must be in original conditions and clearly identified. If after inspection in our warehouse these products are not in original condition, we might apply a devaluation fee.

SERVICIOS POSTVENTA OFRECIDOS POR MT:

Reclamaciones: cualquier reclamación deberá formularse dentro de los treinta (30) días siguientes a la fecha de factura, rechazándose las efectuadas después de dicho plazo límite.

Periodo de desistimiento: conforme la Ley General para la Defensa de los Consumidores y Usuarios, el comprador dispone de catorce (14) días naturales para devolver la totalidad o parte del pedido sin penalización alguna, a contar desde la fecha de factura.

Devoluciones: no se aceptará ninguna devolución de material sin antes existir la conformidad expresa, mediante el número de devolución facilitado, por la empresa (véase nuestra política y proceso de devolución en la web). El plazo máximo admitido para devolver material no conforme es de sesenta (60) días, a contar desde la fecha de factura.

Garantía: todos nuestros productos tienen 2 años de garantía según establece la Ley vigente. Si el defecto se manifiesta pasados los 6 meses después de su compra se requerirá una revisión técnica y/o pericial por nuestro departamento de calidad con tal de poder aplicar su derecho a la garantía. La garantía queda limitada pura y simplemente al reemplazo de las piezas, una vez reconocidas materialmente defectuosas por nuestro personal técnico sin indemnización.

Litigios: en caso de litigio ambas partes aceptan someter sus diferencias a los juzgados y tribunales de Barcelona.

MT Business Key S.L. se reserva la facultad de cambiar en todo o en parte el diseño, materiales, embolsado, encajado y precios de cualquiera de sus productos.

CONDITIONS INSIDE EU:

Even though all purchases are covered by our extended 14-day exchange or refund promise, no material return will be accepted without the conformity of the commercial department.

No unwanted material returned will be accepted after 60 days invoice's date. All unwanted material returned after 14 days of date of invoice and before maximum period of acceptance (60 days) will be charged 30% of demerit.

CONDITIONS OUTSIDE EU:

No unwanted material returned will be accepted after 90 days invoice's date. All unwanted material returned will be charged 30% of demerit.

Litigations: in case of litigation both sides agree to take their differences at the courts of Barcelona.

MT Business Key S.L. reserves the right to modify all or part of the design, materials, packing or prices of any of their products.



Nuevo servicio urgente 24 horas sólo para España
Para paquetería de menos de 10 kg. 7 € en factura.
Para expediciones de menos de 30 kg. 12 € en factura.
Para pedidos superiores a 30 kg de peso, consultar.

New urgent service 24 hours only in Spain
For packages of less than 10 kg. 7 € in invoice
For expeditions of less than 30 kg. 12 € in invoice
For higher orders to 30 kg weight, consult.

ÍNDICE DE REFERENCIAS

REFERENCES INDEX

REF	PAG
4104	20
4504	20
4204	20
4604	20
4304	21
4295	22
42952	22
4097	22
4097	22
4098	22
40982	22
4106	23
41062	23
4102	23
41022	23
4103	23
41032	23
4124	24
4099	24
4105	24
4091	25
40912	25
4092	25
40922	25
4093	26
40932	26
4094	26
40942	26
4125	27
4111	27
4142	27
4144	27
4123	27
4147	27
4146	28
4143	28
4145	28
4148	28
4149	28
4141	28
4122	28
4121	28
0921	28
4404	29
4405	29
4411	29
4402	29
4422	29
4406	29
4426	30
4409	30
4410	30
4400	30

REF	PAG
4401	30
4434	30
4435	30
4407	30
4107	31
4108	31
4109	31
4110	31
41092	31
41102	31
4113	32
4113CE	32
4113I	32
4114	32
4115	32
4215	32
4116	33
4117	33
4118	33
4119	33
4120	33
4221	33
4222	33
4230	33
4224	34
4225	34
4226	34
4415	34
4416	34
4414	34
4413	34
4412	34
4419	34
4417	34
4418	35
4100	35
4101	35
87001	36
87002	36
87090	36
87090R	36
87092	36
87093	36
87098	37
87130	37
87130R	37
87132	37
87180	37
87240	37
87241	38
87245	38
87246	38
87270	38

REF	PAG
87271	38
87280	39
87290	39
87300	39
87315	39
87318	39
87340	40
87341	40
873412	40
87500	40
87529	40
87530	40
87531	40
87532	40
87533	41
87550	41
87562	39
87563	39
87560	41
87561	41
87562	41
87563	42
87575	42
82130	42
82220	42
82270	42
228410	43
228420	43
228421	43
228431	43
871090	44
871092	44
871500	44
871130	44
871240	45
871241	45
871245	45
871246	45
871270	45
871280	45
871290	45
871300	45
871529	46
87534	46
871531	46
86090	47
86092	47
86130	47
86180	47
86472	47
86301	48
86270	48
86243	48

REF	PAG
86359	48
86360	48
86361	48
86362	49
86363	49
98010	50
98020	50
98090	50
98110	50
6601	51
6601R	51
6602	51
6603	51
6604	52
6605	52
6606	52
6607	52
6608	52
6609	52
6610	52
6611	52
6612	53
6650	53
HS501	54
HS502	54
HS505	54
HS506	54
HS507	55
HS508	55
HS509	55
HS510	55
HS511	55
641090	56
641091	56
641092	56
641130	56
641131	57
641132	57
641133	57
641134	57
641135	57
641270	57
641271	57
641272	57
641273	58
641500	58
64015	58
64016	58
640R	58
645	58
640B	59
4131G	60
4134G	60

REF	PAG
4133G	60
41332G	60
4132G	60
4135G	60
41302G	61
41303G	61
0921G	61
4148G	61
4111G	61
4123G	61
4145G	61
4147G	61
001	62
002	62
003	62
040	62
041	63
085	63
092	63
090	63
090R	63
096	63
098	63
221	63
120	64
180	64
130R	64
130	64
223	64
245	64
240	65
241	65
246	65
270	65
290	66
280	66
300	66
301	66
312	66
321	66
340	66
341	67
529	67
0910	68
09102	68
09103	68
09104	68
0914	69
0915	69
0921	69
0913	69
0916	69
8090	70
8120	70
8092	70
8130	70
80902	71
8180	71
8130R	71
8240	71
8149	71

REF	PAG
8150	71
8241	72
8270	72
8280	72
8245	72
8290	73
8300	73
8312	73
8330	73
8340	73
8341	73
8399	74
8531	74
8601	74
8602	74
160101	75
160204	75
160306	75
8400	76
8500	76
8599	76
8600	76
KEY	77
MAC3	77
MAC5	77
E-FLY	77
QUICKSTOP	78
E POWER	78
MAC PRESS	78
SUPER SIMPLEX E	78
1010	78
101010	78
4150	79
4153	79
4151	79
4152	79
4154	79
4155	79
4160	80
4161	80
STOP FLOW	80
4157	81
4156	81
600	82
6002	82
601	82
55007	83
55002	83
55003	83
55001	83
55005	83
55004	83
55006	83
THF ALTA PRESIÓN	84
N-30 SECADO RÁPIDO	84
N-40 SECADO LENTO	84
BLUETITE PVC FLEXIBLE	84
LN-40	84

REF	PAG
PTFE LÍQUIDO	84
DESATASCADOR	85
CINTA PTFE	85
SELLADOR	85
CIANOCRILATO	85
LIMPIADOR	85
170821010	86
170821015	86
170821515	86
170811010	86
170811015	87
170811510	87
170811515	87

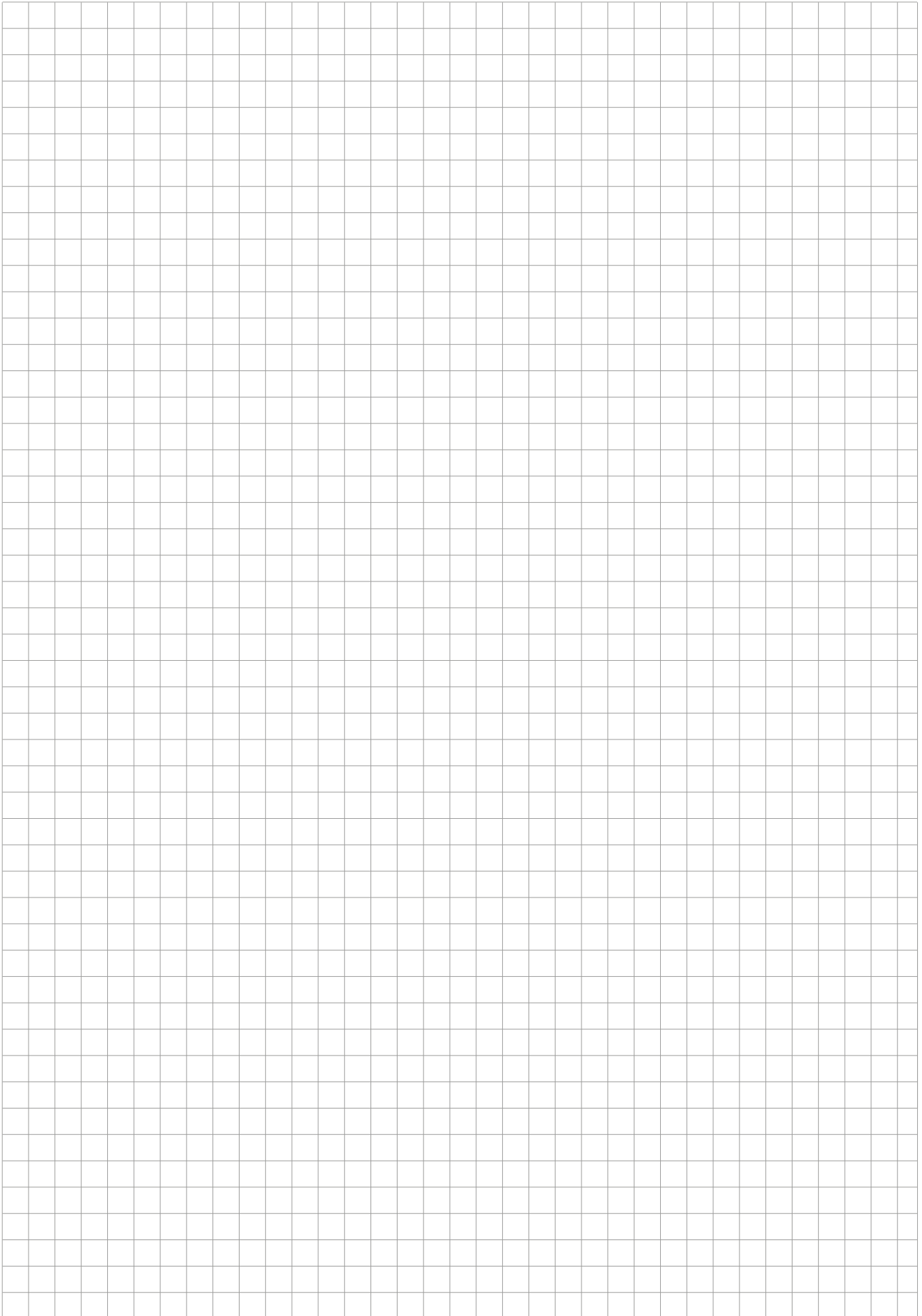

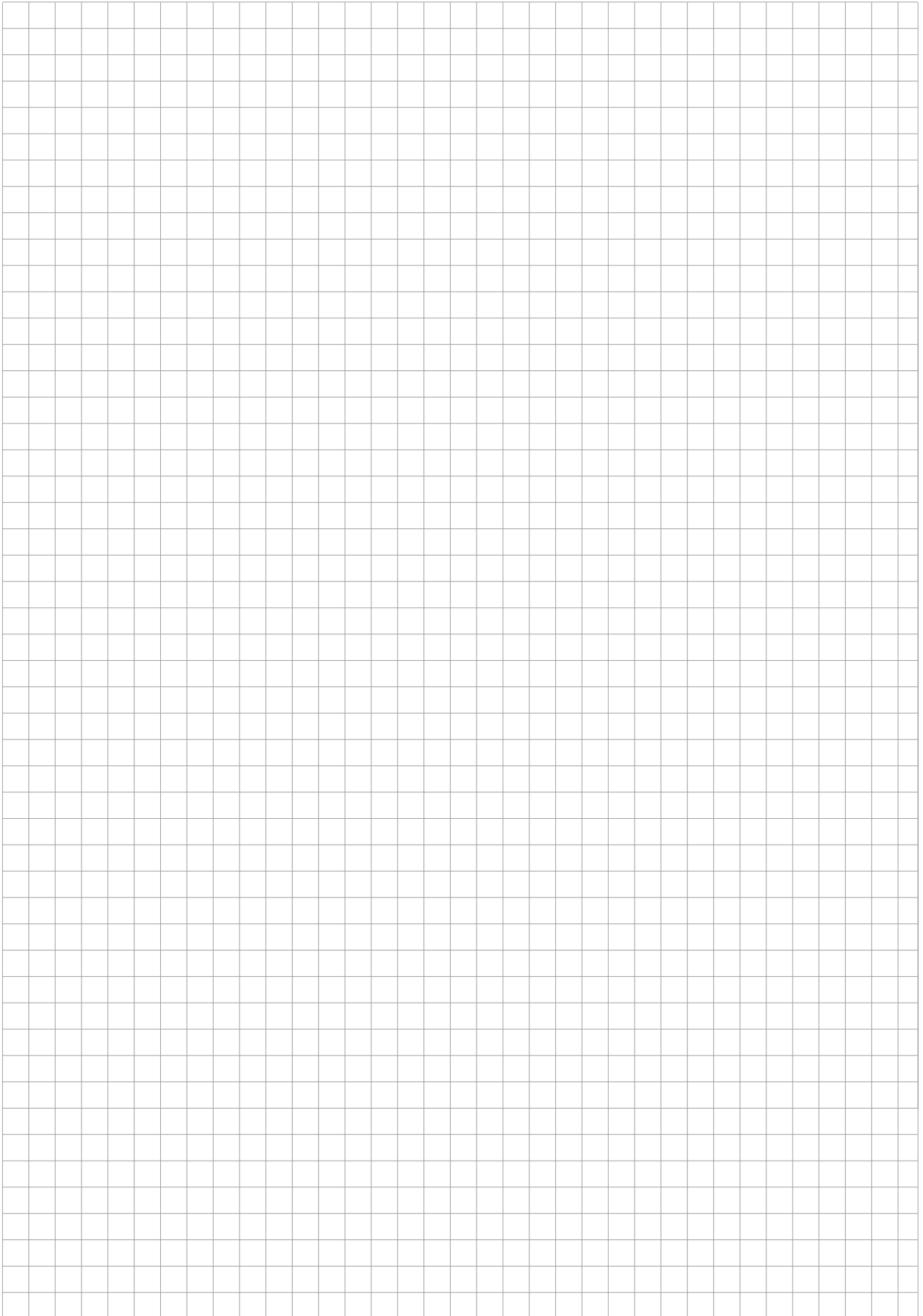

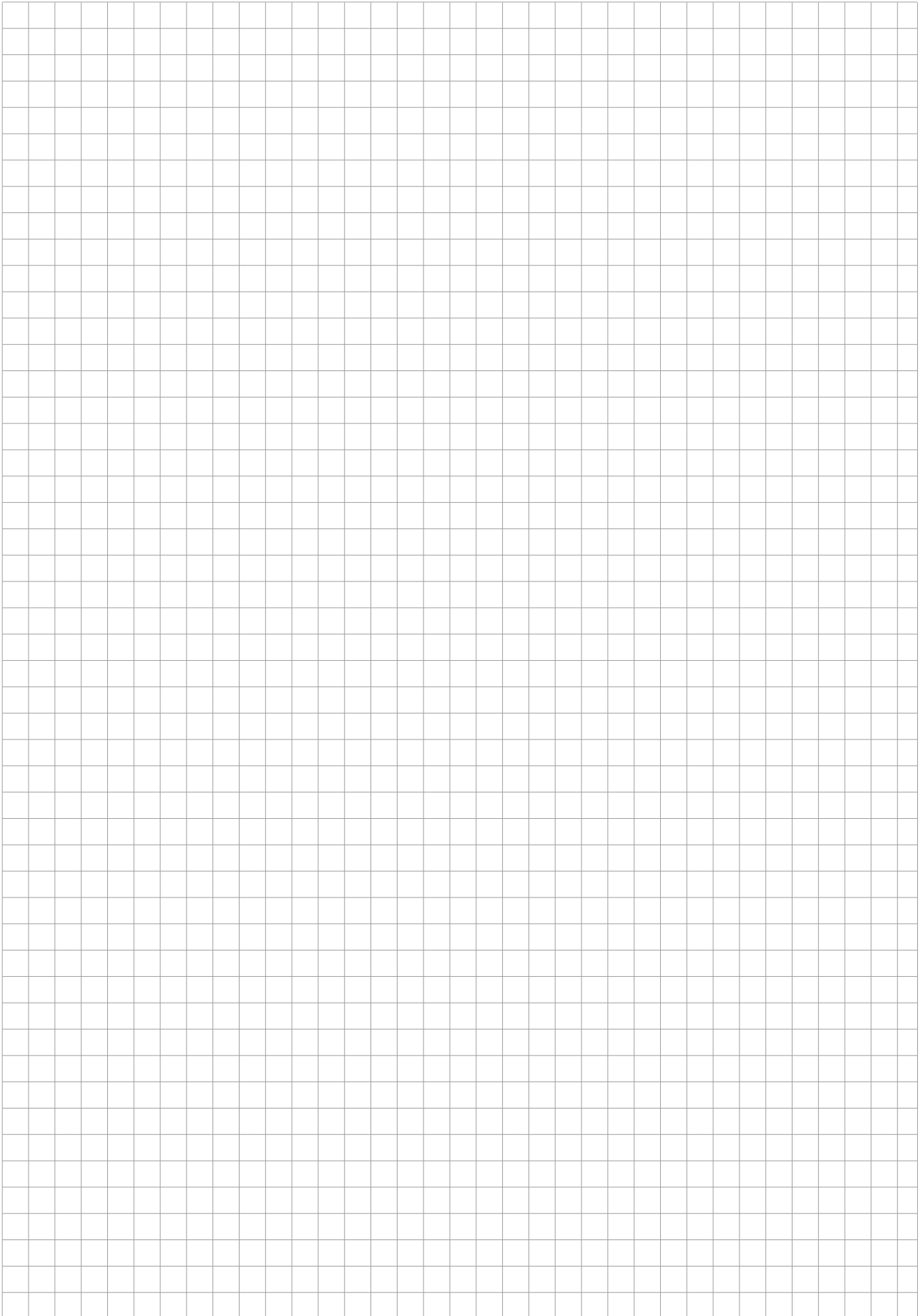

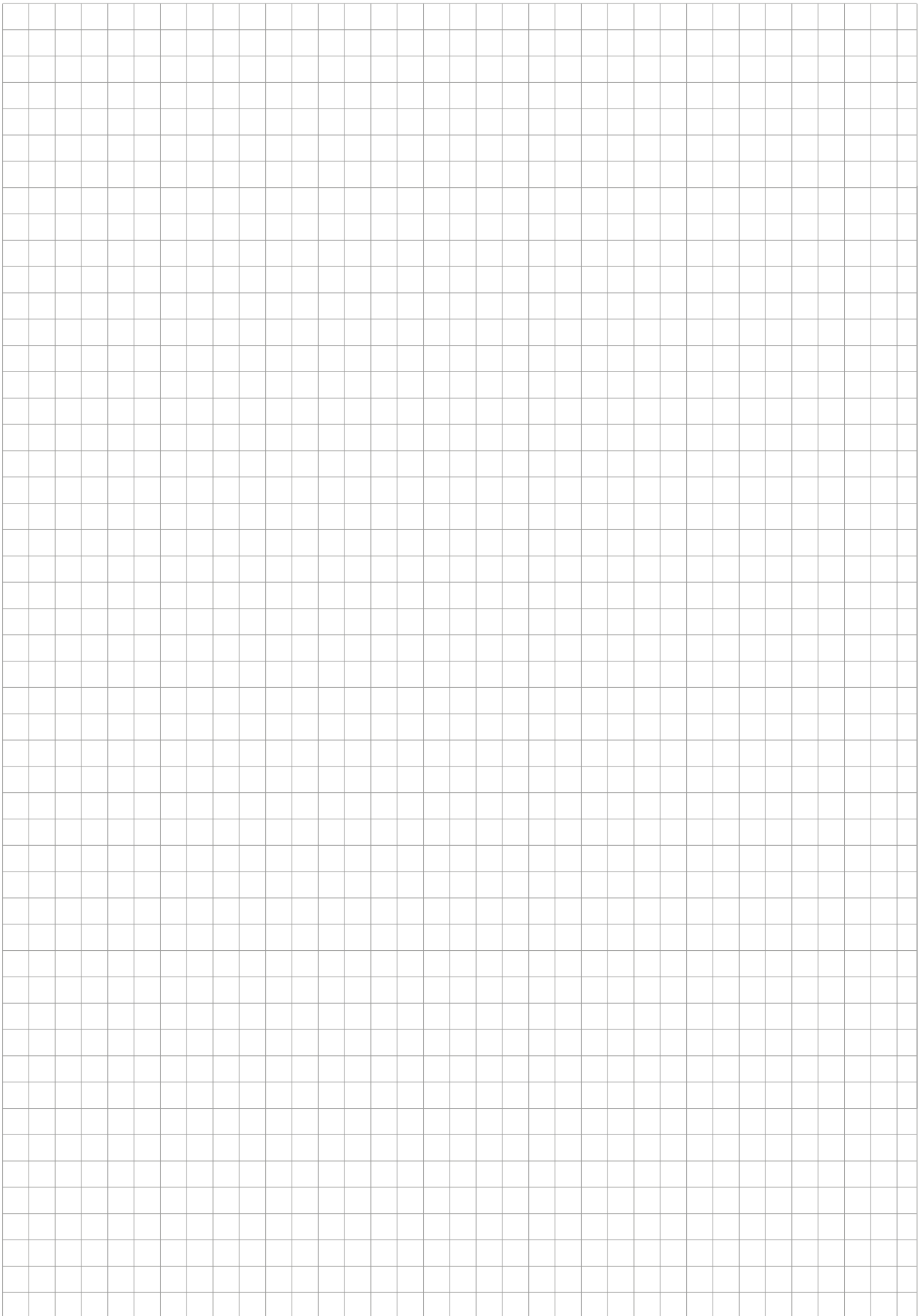

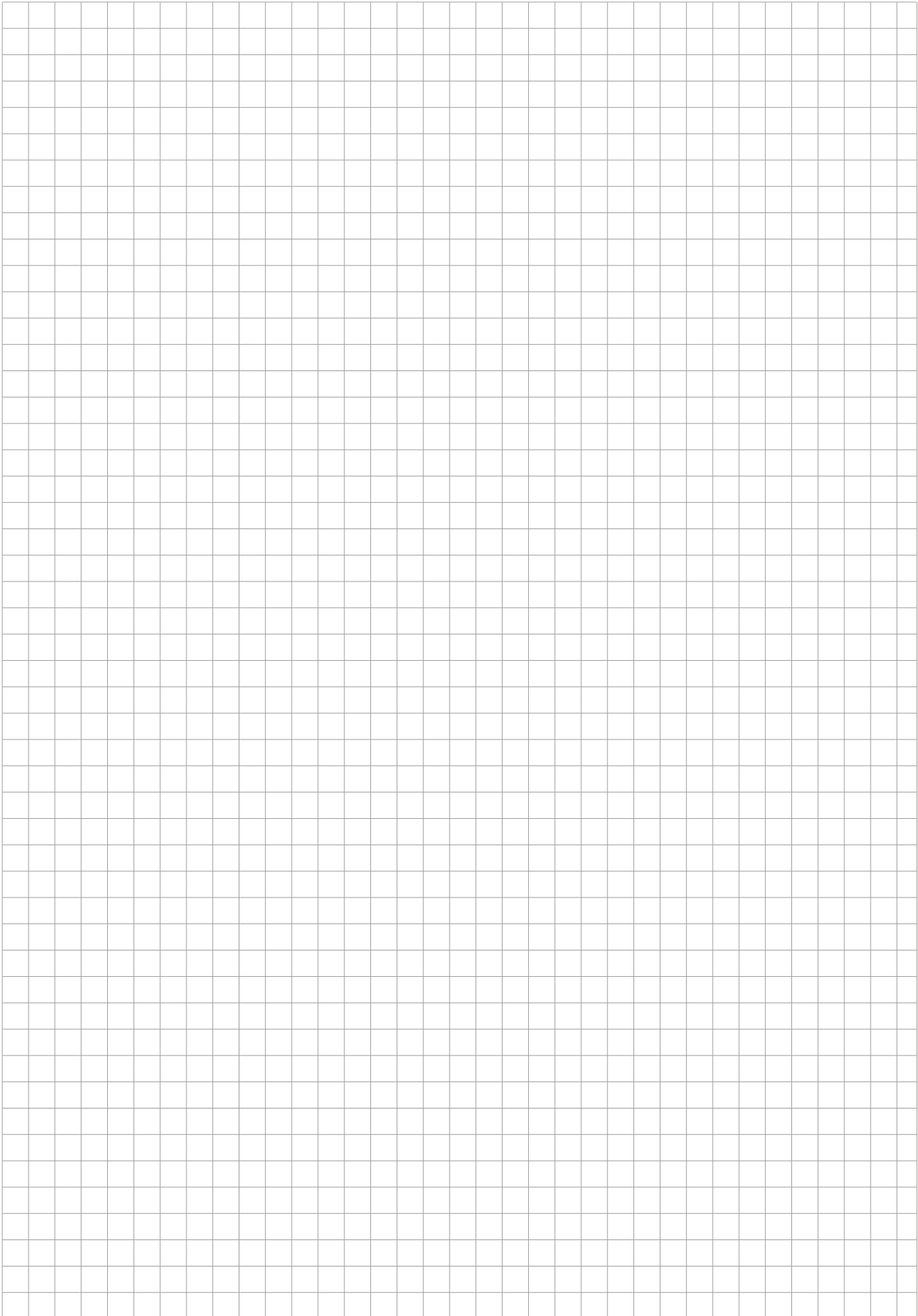



VALVES AND FITTINGS

Tel. +34 936 804 980

Fax. +34 936 804 981

info@mtspain.net

Pol. Sector Camps d'en Ricart
C/ Comerç, 10, naves 4 a 9
08780 Pallejà, Barcelona - SPAIN

mtspain.net

